

Attachment "A" Part 1 of 2

11



County of Fairfax, Virginia

To protect and enrich the quality of life for the people, neighborhoods and diverse communities of Fairfax County

MEMORANDUM OF NEGOTIATION RFP2000000330

The County of Fairfax (hereinafter called the County) and Haworth, Inc. (hereinafter called the Contractor) hereby agree to the following in the execution of Contract 4400003402. The final contract contains the following items:

- a. Fairfax County's RFP2000000330
- b. All Addenda
- c. Haworth, Inc. Technical and Business proposal as amended by this Memorandum of Negotiations
- d. Response to clarifications dated August 7, 2012
- e. The Memorandum of Negotiations

The following are to be included in the contract:

1. This contract will begin on January 1, 2013 and terminate on December 31, 2016. Fairfax County reserves the right to renew the contract for four (4) years, one (1) year at a time by mutual agreement.
2. Revised cost Proposal Attachment A – Price Sheet – submitted via e-mail on August 9, 2012.
3. Discounts will remain firm for the duration of the contract. Discounts will be taken from the prices that are effective at the time of the request for a quote or order.

All other prices, terms, and conditions remain the same.

ACCEPTED BY:

Phil Todd, Director Sales Support
Haworth Inc.

9/20/12

Date

Cathy A. Muse, CPPO
Director/County Purchasing Agent

10/9/12

Date



County of Fairfax, Virginia

To protect and enrich the quality of life for the people, neighborhoods and diverse communities of Fairfax County

OCT 10 2012

Haworth, Inc.
One Haworth Center
Holland, MI 49423

Attention: Phil Todd, Director Sales Support

Reference: RFP2000000330 – Office Furniture and Related Services and Solutions

Dear Mr. Todd:

ACCEPTANCE AGREEMENT

Contract Number: 4400003402

This acceptance agreement signifies a contract award to Haworth, Inc. in its entirety for Office Furniture and Related Services and Solutions. The period of the contract is from January 1, 2013, through December 31, 2016, with four (4), one (1) year renewal options.

The contract award shall be in accordance with the following:

- 1) This Acceptance Agreement;
- 2) The signed Memorandum of Negotiations

Please note that this is not an order to proceed. A Purchase Order, which constitutes your notice to proceed, will be issued by the County. Please provide your Insurance Certificate according to Special Provisions paragraph 14 within ten (10) days of receipt of this letter. Contract award documents may be viewed on the Department of Purchasing and Supply Management website at www.fairfaxcounty.gov/cregister.

Cathy A. Muse, CPPO
Director/County Purchasing Agent

Department of Purchasing and Supply Management
12000 Government Center Parkway, Suite 427
Fairfax, VA 22035
Website: www.fairfaxcounty.gov/dpsm
Phone: 703-324-3201, TTY: 1-800-828-1140, Fax: 703-324-3228



County of Fairfax, Virginia

NOTICE OF AWARD

OCT 10 2012

CONTRACT TITLE: Office Furniture and Related Services and Solutions
RFX NUMBER: 2000000330
COMMODITY CODE: 42594
CONTRACT PERIOD: January 1, 2013, through December 31, 2016
RENEWALS: 4 Renewals, 1 year at a time

SUPERSEDES CONTRACT: RQ07-878957-20

CONTRACTORS: SUPPLIER CODE CONTRACT NUMBER

Haworth, Inc. 1000011672 4400003402
One Haworth Center
Holland MI 49423
Contact: Cyndi Kamps
Telephone: 616-393-1645
E-Mail: Cyndi.kamps@haworth.com
Payment Terms: Net 30 days

Herman Miller, Inc. 1000011666 4400003403
855 East Main Ave.
P. O. Box 302
Zealand, MI 49464
Contact: Dave Gillman, Contract Manager
Telephone: 616-654-8375
E-Mail: dave_gillman@hermanmiller.com
Payment Terms: Net 30 days

Knoll, Inc. 1000011430 4400003404
1235 Water Street
East Greenville, PA 18041
Contact: Steve Robinson, Vice President
Telephone: 202-973-0410
E-Mail: Steven_M_Robinson@knoll.com
Payment Terms: Net 30 days

Department of Purchasing & Supply Management
12000 Government Center Parkway, Suite 427
Fairfax, VA 22035-0013
Website: www.fairfaxcounty.gov/dpsm
Phone (703) 324-3201, TTY: 1-800-828-1140, Fax: (703) 324-3681

Notice of Award
RFX2000000330
Page 2



PRICES: See Attached

DELIVERY: N/A

FOB: Destination

DPSM CONTACT: George Bright, Contract Specialist
Telephone: 703-324-3215
E-mail: george.bright@fairfaxcounty.gov

ORDERING INSTRUCTIONS:

Any county department may enter a shopping cart into FOCUS indicating the item/service required, the quantity, the payment terms, and the delivery date. The shopping cart must include the contract number in the appropriate field. Requests exceeding the County small purchase order threshold (\$10,000) will be routed for approval and a purchase order will be executed.

George Bright, CPPB
Contract Specialist Supervisor

DISTRIBUTION:

Department of Finance – Accounts Payable
Facilities Management Dept. – Rhinda Edwards/e
Facilities Management Dept. – Cathy Spaine/e
Facilities Management Dept. – Shirley Dowell/e
U. S. Communities
2033 N. Main St. Suite 700
Walnut Creek, CA 94596
Attn: Corey Imhoff
Mary Pelfrey

Contract Specialist – G. Bright
Asst. Contract Spec. – Team 2

This pricing document includes competitive pricing for an agency that would like to purchase Haworth products as well as keep the option to purchase from other suppliers.

3

HAWORTH'S US COMMUNITIES MULTIPLE AWARD CONTRACT DISCOUNTS
CUSTOMER COPY

55603 AA for orders shipping to continental U.S. locations, accessing North American price list

Product Group	Systems, Tables and Healthcare Products	Seating	Freestanding	Wood Caseworks & Wood Tables	Flooring/Electrical Architectural Interiors	List Dollar Value	Customer Discount Product Only
I Regular Lead Time Rush	UniGroup® NW/W/T PLACES® NW/W/T and FW, UniGroup® Too Adaptable Components					\$1-\$100,000 \$100,001 or More	61% 68% Negotiable
II Regular Lead Time Rush	IF, RACE®, PREMISE® NW/W/T, Moxie™ Components, Compose					\$1 or More \$1-\$100,000 \$100,001 or More	53% 63% Negotiable
III Regular Lead Time Rush		Monaoco®, Improv®, Look	Beside, X Series® Caseworks, Files & Storage V Series® Caseworks, Files & Storage			\$1 or More \$1-\$50,000 \$50,001 or More	57% 60% Negotiable
IV Regular Lead Time Rush		X99®				\$1 or More \$1-\$50,000 \$50,001 or More	54% 53% Negotiable
V Regular Lead Time Rush	Patterns Reside Openest Inlury, Active Components	Composites™, Foreuze™, Hello™, Tally™, Todd®, Poppy		Masters, Suite		\$1 or More \$1-\$25,000 \$25,001 or More	41% 59% Negotiable
VI Regular Lead Time Rush		Cassis, Candor				\$1 or More \$1-\$25,000 \$25,001 or More	41% 58% Negotiable
VII Regular Lead Time Rush	450 Series, Tempo™, Planes™ Compose Storage, Pin					\$1 or More \$1-\$25,000 \$25,001 or More	53% 41% Negotiable
VIII Regular Lead Time Rush	Jump®Stuff, Boogie Board, Belong, European Product The Haworth Collection NA Products					\$1 or More \$1-\$10,000 \$10,001 or More	55% 57% Negotiable
IX Regular Lead Time Rush		Very™ Very Task				\$1 or More \$1-\$25,000 \$25,001 or More	50% 59% 57% Negotiable
X Regular Lead Time Rush					EnClose	\$1 or More \$1-\$100,000 \$100,001-\$500,000 \$500,001 or More	62% Negotiable
XI Regular Lead Time Rush					TeoCrete®	\$1 to \$100,000 \$100,001 or More	Negotiable

Product Group	Systems, Tables and Escalatore Products	Seating	Freestanding	Wood Casegoods & Wood Tables	Flooring/Electrical Architectural Interiors	Last Dollar Value	Customer Discount Product Only
XII Regular Lead Time					Powerweb	\$1-\$100,000 \$100,001-\$500,000 \$500,001 or More	60% 62% Negotiable
XIII Regular Lead Time	Haworth Collection Polona Frau, Cappellini, Cassina					\$1 or More	15%
XIV Regular Lead Time	Haror Work Lounge					\$1 or More	50%
XV Regular Lead Time	HHE Healthcare					\$1 or More	57.2%
XVI Regular Lead Time			A Series			\$1 or More	53%
XVII Regular Lead Time		Zody				\$1-\$25,000 \$25,001 or More	55% Negotiable
XVIII Regular Lead Time						\$1 or More	41%
XVIII Regular Lead Time		Lively				\$1 or More	60%
XIX Regular Lead Time		Soji				\$1-\$25,000 \$25,001 or More	50% Negotiable
XX Regular Lead Time	Workware					\$1 or More	55%
XXI Regular Lead Time	Everyday Office (Hon, Jump, Jive and Swivel)					\$1 or More	50%
XXII Regular Lead Time	Engcon					\$1 or More	47.5%
XXIII Regular Lead Time		Fern				\$1 or More	50%
XXIV Regular Lead Time	Haworth Collection- Janus et Cie					\$1 or More	15%

**Seller offers the above mentioned discounts on products included in this Agreement which are offered in Seller's RUSH Programs. See the current price list(s) for a description of the products included in these programs.

A. Only the items stated within each product group may be combined on a single purchase order for purposes of attaining a higher discount tier and/or negotiable discount tier. DIFFERENT PRODUCT GROUPS OR LEAD TIMES MAY NOT be combined together for purposes of attaining the next pricing tier.

B. The applicable discount will be separately negotiated for new products or lead time programs introduced by Seller during the term of this Agreement.

HAWORTH'S US COMMUNITIES MULTIPLE AWARD CONTRACT DISCOUNTS
CIF - CUSTOMER COPY

55603 BB for orders shipping to Non-contiguous U.S. and overseas International locations receiving North American price list

Product Group	Systems, Tables and Healthcare Products	Seating	Freestanding	Wood Casegoods & Wood Tables	Flooring/Electrical Architectural Interiors	List Dollar Value	Customer Discount Product Only
I Regular Lead Time	UniGroup® NW/VT PLACES® NW/VT and PW, UniGroup® Too Adaptable Components					\$1-\$100,000 \$100,001 or More	68% Negotiable
Rush						\$1 or More	58%
II Regular Lead Time	RACE® PREMISE® NW/VT, Moxie™ Components, Compose, IF					\$1-\$100,000 \$100,001 or More	65% Negotiable
Rush						\$1 or More	58%
III Regular Lead Time		Monaco®, Imprato®, Look	Beside X Series® Casegoods, Files & Storage V Series® Casegoods, Files & Storage			\$1 or More \$1-\$50,000 \$50,001 or More	50% 60% Negotiable
Rush						\$1 or More	54%
IV Regular Lead Time		X99®				\$1-\$50,000 \$50,001 or More	57% Negotiable
Rush						\$1 or More	54%
V Regular Lead Time	Parsons Reside Openers, Imbuity	Composites™, Fortez™, Hello™, Tally™, TolDo®, Poppy		Masters, Suite		\$1 or More \$1-\$25,000 \$25,001 or More	51% 50% Negotiable
Rush						\$1 or More	38%
VI Regular Lead Time		Cassis, Candor				\$1-\$25,000 \$25,001 or More	52% Negotiable
Rush						\$1 or More	38%
VII Regular Lead Time	450 Series, Tempo™ Planes™, Compose Storage, Pip					\$1 or More \$1-\$25,000 \$25,001 or More	55% Negotiable
Rush						\$1 or More	52%
VIII Regular Lead Time	Jump®Stuff, Boogie Board, Belong, The Haworth Collection NA Products					\$1-\$10,000 \$10,001 or More	38% Negotiable
IX Regular Lead Time		Veri™ Very Task				\$1-\$25,000 \$25,001 or More	52% Negotiable
Rush						\$1 or More	47%
X Regular Lead Time					Enclose	\$1-\$100,000 \$100,001-\$500,000 \$500,001 or More	52% 54% Negotiable
XI Regular Lead Time					Powerweb	\$1-\$100,000 \$100,001-\$500,000 \$500,001 or More	57% 59% Negotiable
XII Regular Lead Time	Harbor Work Lounge					\$1 or More	47%

Product Group	Systems, Tables and Healthcare Products	Seating	Freestanding	Wood Casegoods & Wood Tables	Flooring/Electrical Architectural Interiors	List Dollar Value	Customer Discount Product Only
XII Regular Lead Time	HHE Healthcare					\$1 or More	54.2%
XIV Regular Lead Time			A Series			\$1 or More	53%
XV Regular Lead Time		Zody				\$1-\$25,000 \$25,001 or More	52% Negotiable
XVI Regular Lead Time		Lively				\$1 or More \$1-\$25,000 \$25,001 or More	38% 56.25% Negotiable
XVII Regular Lead Time		Soji				\$1-\$25,000 \$25,001 or More	47% Negotiable
XVIII Regular Lead Time	Workware					\$1 or More	52%
XIX Regular Lead Time	Everyday Office (Hop, Jump, Jive and Swivel)					\$1 or More	47%
XX Regular Lead Time		Ern				\$1 or More	47%
XXI Regular Lead Time	Ergotom					\$1 or More	44.5%
XXII Regular Lead Time	Haworth Collection Poltrona Frau, Cappellini, Casina					\$1 or More	12%
XXIII Regular Lead Time	Haworth Collection- Janus et Cie					\$1 or More	12%

**Seller offers the above mentioned discounts on products included in this Agreement which are offered in Seller's RUSH Programs. See the current price list(s) for a description of the products included in these programs.

A. Only the items stated within each product group may be combined on a single purchase order for purposes of attaining a higher discount tier and/or negotiable discount tier. DIFFERENT PRODUCT GROUPS OR LEAD TIMES MAY NOT be combined together for purposes of attaining the next pricing tier.

B. The applicable discount will be separately negotiated for new products or lead time programs introduced by Seller during the term of this Agreement.

**ATTACHMENT A
PRICE SHEET - HAWORTH'S MULTIPLE AWARD CONTRACT**

PRODUCT	Manufacturer Discount Percent from List Price (or other objectively verifiable criteria)						Volume Discounts (Use more columns as necessary.)
	List Price	Drop Ship*	Inside Delivery	Basic Installation*	Expanded Installation*		
UniGroup Adaptable Components	\$1-\$100,000 \$100,001 and up	71% Negotiable	71% Negotiable	66% to 68.5% off list	64% to 68% off list	71% Negotiable	
IF, RACE	\$1-\$100,000 \$100,001 and up	63% Negotiable	63% Negotiable	63% to 65.5% off list	61% to 65% off list	68% Negotiable	
Accolade Too Casegoods, Files & Storage, 950 Series Files & Storage, Beside, X Series Storage	\$1-\$50,000 \$50,001 and up	63% Negotiable	63% Negotiable	58% to 60.5% off list	56% to 60% off list	63% Negotiable	
K99	\$1-\$50,000 \$50,001 and up	60% Negotiable	60% Negotiable	55% to 57.5% off list	53% to 57% off list	60% Negotiable	
Patterns, Reside, Composites Tally Casegoods Varia Series K Storage	\$1-\$25,000 \$25,001 and up	53% Negotiable	53% Negotiable	48% to 50.5% off list	46% to 50% off list	53% Negotiable	
Tactics Tempo, Zoo Chu	\$1-\$25,000 \$25,001 and up	58% Negotiable	58% Negotiable	53% to 55.5% off list	51% to 55% off list	58% Negotiable	
Jump The Haworth Collection, BRAZO, Um	\$1-\$10,000 \$10,001 and up	41% Negotiable	41% Negotiable	36% to 38.5% off list	34% to 38% off list	41% Negotiable	
Zody, Very Task	\$1-\$25,000 \$25,001 and up	55% Negotiable	55% Negotiable	50% to 52.5% off list	48% to 52% off list	55% Negotiable	
Healthcare	\$1-\$100,000 \$100,001 and up	47% Negotiable	47% Negotiable	42% to 44.5% off list	40% to 44% off list	47% Negotiable	
Other Related Products							
Enclose Walls	\$1-\$100,000 \$100,001-\$500,000 \$500,001 and up	55% 57% Negotiable	55% 57% Negotiable	Architectural Products are quoted by project	Architectural Products are quoted by project	55% 57% Negotiable	
Lifespace Walls	\$1-\$100,000 \$100,001-\$500,000 \$500,001 and up	56% 58% Negotiable	56% 58% Negotiable	Architectural Products are quoted by project	Architectural Products are quoted by project	56% 58% Negotiable	
Tecrete Flooring	\$1-\$100,000 \$100,000 and up	62% Negotiable	62% Negotiable	Architectural Products are quoted by project	Architectural Products are quoted by project	62% Negotiable	
Powerweb	\$1-\$100,000 \$100,001-\$500,000 \$500,001 and up	60% 62% Negotiable	60% 62% Negotiable	Architectural Products are quoted by project	Architectural Products are quoted by project	60% 62% Negotiable	
Additional Services and Solutions							
		Hourly Rates (A range is acceptable)					
Installation		\$78	\$36				
After Hours Installation		\$39	\$54				
Holidays and Sunday Installation		\$56	\$72				
Design		\$60	\$75				
Project Management		\$35	\$45				
Asset Management		\$18	\$78				
Refurbishment		\$32	\$42				
Mosaic Procurement Tool - Silver Level		No Charge	No Charge				
		Monthly Fee Include any additional options offered					
Storage (per cubic square foot)		\$0.85	\$1.60				
Other Related Services and Solutions							
		Hourly Rates					
Reconfiguration		\$28	\$36				
After Hours Installation		\$39	\$54				
Holidays and Sunday Installation		\$56	\$72				

Note:

Installation pricing based on the following:

- Performed during normal business hours 7:00 am to 5:00 pm Monday through Friday - no holidays
- Non-union labor
- Free and clear access to loading docks and elevators
- Job site to be free and clear of other trades
- Reasonable access to Space
- Where applicable, Haworth will abide by union or prevailing wage rates



U.S. COMMUNITIES
GOVERNMENT PURCHASER ALLIANCE

This pricing document includes the committed discount structure for agencies that agree to purchase substantially all of their interior solutions from Haworth. Your commitment to purchase Haworth's complete offering of interior solutions provides a more economical purchasing solution.

HAWORTH US COMMUNITIES COMMITTED PRICING CONTRACT
DISCOUNTS CUSTOMER COPY

N121126 / 55611 AA for orders shipping to continental U.S. locations, accessing North American price list

Product Group	Systems, Tables and Healthcare Products	Seating	Freestanding	Wood Caseworks & Wood Tables	Flooring/Electrical Architectural Interiors	List Dollar Value	Customer Discount
I Regular Lead Time	UniGroup® NW/WT PLACES® NW/WT and FW, UniGroup® Top Adornabe Components					\$1-\$100,000 \$100,001 or More	73% Negotiable
Rush						\$1 or More	63%
II Regular Lead Time	IF, RACE®, PREMISE® NW/WT, Moxie™, Components, Compose					\$1-\$100,000 \$100,001 or More	70% Negotiable
Rush						\$1 or More	53%
III Regular Lead Time		Monaco®, Improve®, Look	Beside X Series® Caseworks, Files & Storage V Series® Caseworks, Files & Storage			\$1-\$50,000 \$50,001 or More	65% Negotiable
Rush						\$1 or More	59%
IV Regular Lead Time		X99®				\$1-\$50,000 \$50,001 or More	62% Negotiable
Rush						\$1 or More	56%
V Regular Lead Time	Patterns Reside Openair Jodity, Active Components	Composites™ Forevar™, Hello™, Tally™, Toddo®, Poppy		Masters, Suite		\$1-\$25,000 \$25,001 or More	55% Negotiable
Rush						\$1 or More	43%
VI Regular Lead Time		Cassia, Candor				\$1-\$25,000 \$25,001 or More	55% Negotiable
Rush						\$1 or More	43%
VII Regular Lead Time	Tactics®, 450 Series, Tempo™, Planes™ Compose Wood, Immerse, Pin					\$1-\$25,000 \$25,001 or More	60% Negotiable
Rush						\$1 or More	57%
VIII Regular Lead Time	Jump®/Stuff BRAZO Boogie Board, Belong, European Product The Haworth Collection BRAZO, Lim.					\$1-\$10,000 \$10,001 or More	41% Negotiable
IX Regular Lead Time		Zody Very™ Very™ Task				\$1-\$25,000 \$25,001 or More	57% Negotiable
Rush						\$1 or More	50%
X Regular Lead Time					Enclose	\$1-\$100,000 \$100,001-\$500,000 \$500,001 or More	55% 57% Negotiable
XI Regular Lead Time					TacCreate®	\$1 to \$100,000 \$100,001 or More	62% Negotiable

XII Regular Lead Time					Powerweb	\$1-\$100,000	60%
XIII Regular Lead Time	Poltrona Frau					\$100,001-\$500,000 \$500,001 or More	62% Negotiable
XIV Regular Lead Time	Harbor Work Lounge					\$1 or More	52%
XV Regular Lead Time	HHE Healthcare					\$1 or More	57.2%
XVI Regular Lead Time			A Series			\$1 or More	53%
XVII Regular Lead Time		Lively				\$1 or More	60%
XVIII Regular Lead Time			Soji			\$1-\$25,000 \$25,001 or More	52%
XIX Regular Lead Time	Workware					\$1 or More	55%
XX Regular Lead Time	Everyday Office (Hop, Jump, Jive, and Swivel)					\$1 or More	50%
XXI Regular Lead Time	Ergotron					\$1 or More	50%
XXII Regular Lead Time		Fern				\$1 or More	50%
XXIII Regular Lead Time	Haworth Collection- Janus et Cie					\$1 or More	17%

**Seller offers the above mentioned discounts on products included in this Agreement which are offered in Seller's RUSH Programs. See the current price list(s) for a description of the products included in these programs.

- A. Only the items stated within each product group may be combined on a single purchase order for purposes of attaining a higher discount tier and/or negotiable discount tier. DIFFERENT PRODUCT GROUPS OR LEAD TIMES MAY NOT be combined together for purposes of attaining the next pricing tier.
- B. The applicable discount will be separately negotiated for new products or lead time programs introduced by Seller during the term of this Agreement.

**HA WORTH US COMMUNITIES COMMITTED PRICING
CONTRACT DISCOUNTS CIF CUSTOMER COPY**

N121126 / 55611 BB for orders shipping to Non-continental U.S. and overseas International locations, accessing North American price list

Product Group	Systems, Tables and Healthcare Products	Seating	Freestanding	Wood Caseworks & Wood Tables	Flooring/Electrical Architectural Interiors	List Dollar Value	Customer Discount Product Only
I Regular Lead Time	UniGroup® NW/W/T PLACES® NW/W/T and FW, UniGroup® Too Adaptable Components					\$1-\$100,000 \$100,001 or More	70% Negotiable
Rush						\$1 or More	60%
II Regular Lead Time	FF, RACE®, PREMISE® NW/W/T, Moxie™, Components, Compose					\$1-\$100,000 \$100,001 or More	67% Negotiable
Rush						\$1 or More	52%
III Regular Lead Time		Monaco®, Improv®, Look	Basile, X Series® Caseworks, Files & Storage V Series® Caseworks, Files & Storage			\$1-\$50,000 \$50,001 or More	62% Negotiable
Rush						\$1 or More	56%
IV Regular Lead Time		X99®				\$1-\$50,000 \$50,001 or More	59% Negotiable
Rush						\$1 or More	33%
V Regular Lead Time	Patterns Reside Openst Inuity, Active Components	Composites™ Forenze™, Hello™, Tally™, Todd®, Poppy		Masters, Suite		\$1-\$25,000 \$25,001 or More	52% Negotiable
Rush						\$1 or More	40%
VI Regular Lead Time		Cassis, Candor				\$1-\$25,000 \$25,001 or More	52% Negotiable
Rush						\$1 or More	38%
VII Regular Lead Time	Tactics®, 450 Series, Tempo™, Planes™ Compose Wood, Immerse, Pip					\$1-\$25,000 \$25,001 or More	57% Negotiable
Rush						\$1 or More	54%
VIII Regular Lead Time	Jump®/Stuff BRAZO Beogie Board, Belong, European Product The Haworth Collection BRAZO, Lim					\$1-\$10,000 \$10,001 or More	40% Negotiable
IX Regular Lead Time		Zody Very™ Very™ Task				\$1-\$25,000 \$25,001 or More	54% Negotiable
Rush						\$1 or More	47%
X Regular Lead Time					Enclose	\$1-\$100,000 \$100,001-\$500,000 \$500,001 or More	52% 54% Negotiable
XI Regular Lead Time					Powerweb	\$1-\$100,000 \$100,001-\$500,000 \$500,001 or More	57% 59% Negotiable
XII Regular Lead Time	Harbor Work Lounge					\$1 or More	49%

Product Group	Systems, Tables and Healthcare Products	Seating	Freestanding	Wood Caseworks & Wood Tables	Flooring/Electrical Architectural Interiors	List Dollar Value	Customer Discount Product Only
XIII Regular Lead Time	HHE Healthcare					\$1 or More	54.7%
XIV Regular Lead Time			A Series			\$1 or More	50%
XV Regular Lead Time		Lively				\$1-\$25,000 \$25,001 or More	57% Negotiable
XVI Regular Lead Time		Soft				\$1-\$25,000 \$25,001 or More	49% Negotiable
XVII Regular Lead Time	Workware					\$1 or More	52%
XVIII Regular Lead Time	Everyday Office (Hop, Jump, Jive, and Swivel)					\$1 or More	47%
XIX Regular Lead Time	Ergotron					\$1 or More	47%
XX Regular Lead Time		Fem				\$1 or More	47%
XXI Regular Lead Time	Haworth Collection- Janus et Cie					\$1 or More	14%

**Seller offers the above mentioned discounts on products included in this Agreement which are offered in Seller's RUSH Programs. See the current price list(s) for a description of the products included in these programs
A. Only the items stated within each product group may be combined on a single purchase order for purposes of attaining a higher discount tier and/or negotiable discount tier. DIFFERENT PRODUCT GROUPS OR LEAD TIMES MAY NOT be combined together for purposes of attaining the next pricing tier.
B. The applicable discount will be separately negotiated for new products or lead time programs introduced by Seller during the term of this Agreement.



U.S. COMMUNITIES
GOVERNMENT PURCHASING ALLIANCE

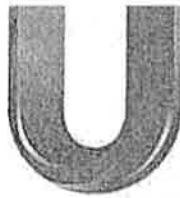

U.S. COMMUNITIES™
GOVERNMENT PURCHASING ALLIANCE



COMPETITIVE SOLICITATION

BY FAIRFAX COUNTY

FOR

**SYSTEMS FURNITURE, FREESTANDING FURNITURE, SEATING, FILING
EQUIPMENT AND RELATED PRODUCTS, SUPPORT SERVICES AND
SOLUTIONS**

ON BEHALF OF ITSELF AND OTHER GOVERNMENT AGENCIES

AND MADE AVAILABLE THROUGH THE U.S. COMMUNITIES

GOVERNMENT PURCHASING ALLIANCE

RFP2000000330

PRE-PROPOSAL CONFERENCE

RFP2000000330

A pre-proposal conference will be held on July 2, 2012 at 1:30 pm local time at the Fairfax County Government Center, 12000 Government Center Parkway, Conference Rooms 9 and 10, Fairfax, Virginia. The purpose of this conference is to allow potential Offerors an opportunity to present questions and obtain clarification relative to any facet of this solicitation.

While attendance at this conference will not be a prerequisite to submitting a proposal, Offerors who intend to submit a proposal are encouraged to attend. Bring a copy of the solicitation with you. Any changes resulting from this conference will be issued in a written addendum to the solicitation.

All questions pertaining to this RFP should be submitted in writing to the contract Specialist, George Bright at dpsmteam2@fairfaxcounty.gov prior to the pre-proposal conference.



FAIRFAX COUNTY

DEPARTMENT OF PURCHASING & SUPPLY MANAGEMENT
12000 GOVERNMENT CENTER PARKWAY, SUITE 427
FAIRFAX, VIRGINIA 22035-0013
www.fairfaxcounty.gov/dpsm

VIRGINIA

TELEPHONE: (703) 324-3201 FAX: (703) 324-3228 TTY: 1-800-828-1140

ISSUE DATE: June 12, 2012	REQUEST FOR PROPOSAL NUMBER: 2000000330	TITLE: Office Furniture and Related Services and Solutions
DEPARTMENT: Facilities Management	DUE DATE/TIME: July 19, 2012 @ 3:00 p.m.	CONTRACT SPECIALIST : George Bright, CPPB 703.324.3215; george.bright@fairfaxcounty.gov

Proposals - In accordance with the following and in compliance with all terms and conditions, unless otherwise noted, the undersigned offers and agrees, if the proposal is accepted, to furnish items or services for which prices are quoted, delivered or furnished to designated points within the time specified. It is understood and agreed that with respect to all terms and conditions accepted by Fairfax County the items or services offered and accompanying attachments shall constitute a contract.

Note: Fairfax County does not discriminate against faith-based organizations in accordance with the Code of Virginia, § 2.2-4343.1 or against a bidder or Offeror because of race, religion, color, sex, national origin, age, disability, or any other basis prohibited by state law relating to discrimination in employment in the performance of its procurement activity.

NAME AND ADDRESS OF FIRM:

Telephone/Fax No.:

E-Mail Address:

Federal Employer Identification No or

Federal Social Security No. (Sole Proprietor)

Prompt Payment Discount: ___% for payment within ___ days/net ___ days

State Corporation Commission (SCC) Identification No.

By signing this proposal, Offeror certifies, acknowledges, understands, and agrees to be bound by the conditions set forth in the General Conditions and Instructions to Bidders as described in Appendix A.

BUSINESS CLASSIFICATION – Described in Appendix B - CHECK ONE: LARGE (Y) SMALL (B)
 MINORITY-OWNED SMALL (X) MINORITY OWNED LARGE (V) WOMEN-OWNED SMALL (C)
 WOMEN OWNED LARGE (A) NON PROFIT (9)

CHECK ONE: INDIVIDUAL PARTNERSHIP CORPORATION
State in which Incorporated: _____

Vendor Legally Authorized Signature

Date

Print Name and Title

Secretary

Sealed proposals subject to terms and conditions of this Request for Proposal will be received by the Fairfax County Purchasing Agent at 12000 Government Center Parkway, Suite 427, Fairfax, Virginia 22035-0013 until the date/time specified above.

AN EQUAL OPPORTUNITY PURCHASING ORGANIZATION



Table of Contents

Introduction and Background	5
Overview.....	5
U.S. Communities.....	7
Supplier Qualifications	10
Commitments	10
U.S. Communities Administration Agreement	15
Supplier Worksheet	16
New Supplier Implementation Checklist.....	17
Supplier Information	19
Fairfax County Special Provisions	23
Attachment A (Price Sheet)	34
Attachment B (Sample Project)	35
Attachment C (References)	36
Appendix A (General Conditions and Instructions to Bidders)	37
Appendix B	49
Offeror Data Sheet.....	49
Business, Professional and occupational License.....	50
Appendix C (Master Intergovernmental Cooperative Purchasing Agreement)	52
Appendix D (Administration Agreement)	54
State Notice Addendum	67
FEMA Standard Terms and Conditions Addendum	105

INTRODUCTION AND BACKGROUND OVERVIEW

1. MASTER AGREEMENT

Fairfax County (herein "Lead Public Agency") on behalf of itself and all states, local governments, school districts, and higher education institutions in the United States of America, and other government agencies and nonprofit organizations (herein "Participating Public Agencies") is soliciting proposals from qualified suppliers to enter into a Master Agreement for a complete line of Systems Furniture, Freestanding Furniture, Seating, Filing Equipment and Related Products, Support Services and Solutions (herein "Products and Services").

ALL PRODUCTS OFFERED MUST BE NEW, UNUSED, LATEST DESIGN AND TECHNOLOGY.

2. OBJECTIVES

- A. Provide a comprehensive competitively solicited Master Agreement offering Products and Services to Participating Public Agencies;
- B. Establish the Master Agreement as a Supplier's primary offering to Participating Public Agencies;
- C. Achieve cost savings for Suppliers and Participating Public Agencies through a single competitive solicitation process that eliminates the need for multiple bids or proposals;
- D. Combine the volumes of Participating Public Agencies to achieve cost effective pricing;
- E. Reduce the administrative and overhead costs of Suppliers and Participating Public Agencies through state of the art ordering and delivery systems;
- F. Provide Participating Public Agencies with environmentally responsible products and services.

3. GENERAL DEFINITION OF PRODUCTS AND/OR SERVICES

Suppliers are to propose the broadest selection of SYSTEMS FURNITURE, FREESTANDING FURNITURE, SEATING, FILING EQUIPMENT AND RELATED PRODUCTS, SUPPORT SERVICES AND SOLUTIONS offered. The intent of this solicitation is to provide Participating Public Agencies with services to meet their various needs. Therefore, the Suppliers should have demonstrated experience in providing Services as defined in this RFP, including but not limited to the following:

- A. Systems Furniture – The complete catalog of all systems furniture, lines, and accessories available from the Supplier;
- B. Freestanding Furniture – The complete catalog of all case goods, furniture and accessories available from the Supplier;
- C. Seating – The complete catalog of chairs and other seating available from the Supplier;
- D. Filing Systems and Equipment – The complete catalog of filing systems, freestanding file cabinets and equipment and accessories available from the Supplier;
- E. Related Products, Support Services and Solutions – Related office interior products and design, installation, systems furniture reconfiguration, assessment tools, and any other services or solutions offered by Supplier.

INTRODUCTION AND BACKGROUND U.S. COMMUNITIES

4. U.S. COMMUNITIES

U.S. Communities Government Purchasing Alliance (herein "U.S. Communities") assists Participating Public Agencies to reduce the cost of purchased goods through strategic sourcing that combines the volumes and the purchasing power of public agencies nationwide. This is accomplished through an award of competitively solicited contracts for high quality products and services by large and well recognized public agencies (herein "Lead Public Agencies"). The contracts provide for use by not only the respective Lead Public Agency, but also by other Participating Public Agencies.

National Sponsors

U.S. Communities is jointly sponsored by the National Institute of Governmental Purchasing (NIGP), the National Association of Counties (NACo), the National League of Cities (NLC), the Association of School Business Officials International (ASBO) and the United States Conference of Mayors (USCM) (herein "National Sponsors").

Advisory Board

The U.S. Communities Advisory Board is made up of key government purchasing officials from across the United States. Each Advisory Board Member is expected to actively participate in product bids and selection, participate in policy direction, and share expertise and purchasing innovations.

Current U.S. Communities Advisory Board Members

North Carolina State University, NC	Hillsborough Schools, FL
City of Los Angeles, CA	City of Houston, TX
Cobb County, GA	Los Angeles County, CA
Denver Public Schools, CO	Maricopa County, AZ
Fresno Unified School District, CA	Miami-Dade County, FL
City and County of Denver, CO	Salem-Keizer School District, OR
Hennepin County, MN	City of San Antonio, TX
Emory University, GA	San Diego Unified School District, CA
Fairfax County, VA	City of Seattle, WA
Harford County Public Schools, MD	Great Valley School District, PA
City of Kansas City, MO	Auburn University, AL

Participating Public Agencies

Today more than 50,000 public agencies utilize U.S. Communities contracts and suppliers to procure over \$1.2 Billion Dollars in products and services annually. Each month more than 400 new public agencies register to participate. The continuing rapid growth of public agency participation is fueled by the program's proven track record of providing public agencies unparalleled value.

The Supplier(s) must communicate directly with any Participating Public Agency concerning the placement of orders, issuance of the purchase order, contractual disputes, invoicing, and payment.

INTRODUCTION AND BACKGROUND U.S. COMMUNITIES

Fairfax County is acting as "Contracting Agent" for the Participating Public Agencies and shall **not** be held liable for any costs, damages, expenses, fees, liabilities, etc. incurred by any other Participating Public Agency.

Each Participating Public Agency enters into a Master Intergovernmental Cooperative Purchasing Agreement (MICPA) outlining the terms and conditions that allow access to the Lead Public Agencies' Master Agreements. Under the terms of the MICPA, the procurement by the Participating Public Agency shall be construed to be in accordance with, and governed by, the laws of the state in which the Participating Public Agency resides. A copy of the MICPA is attached as Appendix C.

Estimated Volume

The estimated dollar volume of Products and Services purchased under the proposed Master Agreement is \$300 Million Dollars annually. This estimate is based on the anticipated volume of the Lead Public Agency, the U.S. Communities Advisory Board members, and current sales within the U.S. Communities program. While there is no minimum quantity of products required to be purchased under the proposed Master Agreement, Fairfax County and the U.S. Communities Advisory Board Members are committed to utilizing the Master Agreement. The Advisory Board members shall determine if the Master Agreement is of value to their agency, and will promote the Master Agreement among other public agencies nationwide and internationally. The Advisory Board in 2011 purchased more than \$85 Million Dollars of products and services from existing U.S. Communities contracts.

Marketing Support

U. S. Communities provides marketing support for each Supplier's products through the following:

- National Sponsors as referenced above.
- State Associations of Counties, Schools and Municipal Leagues.
- Administrative and marketing personnel that directly promote the U.S. Communities Suppliers to Participating Public Agencies through public agency meetings, direct mail, national publications, annual meetings and a network of K-12, City, County, Higher Education and State Associations.
- U.S. Communities provides Suppliers government sales training, and a host of online marketing and sales management tools to effectively increase sales through U.S. Communities.

Marketplace

U.S. Communities has developed an online Marketplace, which gives Participating Public Agencies the ability to purchase from many U.S. Communities contracts directly from our website. The Marketplace makes it easier for Participating Public Agencies to access many contracts through a single login and place orders using a procurement card, credit card or purchase order. Suppliers have the ability to add their products to the Marketplace at no cost.

INTRODUCTION AND BACKGROUND U.S. COMMUNITIES

Multiple Awards

Multiple awards may be issued as a result of the solicitation. Multiple Awards will ensure that any ensuing Master Agreements fulfill current and future requirements of the diverse and large number of Participating Public Agencies.

Evaluation of Proposals

Proposals will be evaluated by the Lead Public Agency in accordance with, and subject to, the relevant statutes, ordinances, rules and regulations that govern its procurement practices.

U.S. Communities Advisory Board members and other Participating Public Agencies will assist the Lead Public Agency in evaluating proposals. The Supplier(s) that respond(s) affirmatively meets the requirements of this Request for Proposal and provides the best overall value will be eligible for a contract award. U.S. Communities reserves the right to make available or not make available Master Agreements awarded by a Lead Public Agency to Participating Public Agencies.

SUPPLIER QUALIFICATIONS COMMITMENTS

SUPPLIERS

Commitments

U.S. Communities views the relationship with an awarded Supplier as an opportunity to provide maximum benefit to both the Participating Public Agencies and to the Supplier.

The successful foundation of the partnership requires commitments from both U.S. Communities and the Supplier. U.S. Communities requires the Supplier to make the four commitments set forth below (Corporate, Pricing, Economy, Sales) to ensure that Supplier is providing the highest level of public benefit to Participating Public Agencies:

(a) Corporate Commitment.

- (i) The pricing, terms and conditions of the Master Agreement shall, at all times, be Supplier's primary contractual offering of Products and Services to Public Agencies. All of Supplier's direct and indirect marketing and sales efforts to Public Agencies shall demonstrate that the Master Agreement is Supplier's primary offering and not just one of Supplier's contract options.
- (ii) Supplier's sales force (including inside, direct and/or authorized dealers, distributors and representatives) shall always present the Master Agreement when marketing Products or Services to Public Agencies.
- (iii) Supplier shall advise all Public Agencies that are existing customers of Supplier as to the pricing and other value offered through the Master Agreement.
- (iv) Upon authorization by a Public Agency, Supplier shall transition such Public Agency to the pricing, terms and conditions of the Master Agreement.
- (v) Supplier shall ensure that the U.S. Communities program and the Master Agreement are actively supported by Supplier's senior executive management.
- (vi) Supplier shall provide a national/senior management level representative with the authority and responsibility to ensure that the Supplier's Commitments are maintained at all times. Supplier shall also designate a lead referral contact person who shall be responsible for receiving communications from U.S. Communities concerning new Participating Public Agency registrations and for ensuring timely follow-up by Supplier's staff to requests for contact from Participating Public Agencies. Supplier shall also provide the personnel necessary to implement and support a supplier-based internet web page dedicated to Supplier's U.S. Communities program and linked to U.S. Communities' website and shall implement and support such web page.
- (vii) Supplier shall demonstrate in its procurement solicitation response and throughout the term of the Master Agreement that national/senior management fully supports the U.S. Communities program and its commitments and requirements. National/Senior management is defined as the executive(s) with companywide authority.

SUPPLIER QUALIFICATIONS COMMITMENTS

- (viii) Where Supplier has an existing contract for Products and Services with a state, Supplier shall notify the state of the Master Agreement and transition the state to the pricing, terms and conditions of the Master Agreement upon the state's request. Regardless of whether the state decides to transition to the Master Agreement, Supplier shall primarily offer the Master Agreement to all Public Agencies located within the state.

(b) Pricing Commitment.

- (i) Supplier represents to U.S. Communities that the pricing offered under the Master Agreement is the lowest overall available pricing (net to purchaser) on Products and Services that it offers to Public Agencies. Supplier's pricing shall be evaluated on either an overall project basis or the Public Agency's actual usage for more frequently purchased Products and Services.
- (ii) Contracts Offering Lower Prices. If a pre-existing contract and/or a Public Agency's unique buying pattern provide one or more Public Agencies a lower price than that offered under the Master Agreement, Supplier shall match that lower pricing under the Master Agreement and inform the eligible Public Agencies that the lower pricing is available under the Master Agreement. If an eligible Public Agency requests to be transitioned to the Master Agreement, Supplier shall do so and report the Public Agency's purchases made under the Master Agreement going forward. The price match only applies to the eligible Public Agencies. Below are three examples of Supplier's obligation to match the pricing under Supplier's contracts offering lower prices.
- (A) Supplier holds a state contract with lower pricing that is available to all Public Agencies within the state. Supplier would be required to match the lower state pricing under the Master Agreement and make it available to all Public Agencies within the state.
- (B) Supplier holds a regional cooperative contract with lower pricing that is available only to the ten cooperative members. Supplier would be required to match the lower cooperative pricing under the Master Agreement and make it available to the ten cooperative members.
- (C) Supplier holds a contract with an individual Public Agency. The Public Agency contract does not contain any cooperative language and therefore other Public Agencies are not eligible to utilize the contract. Supplier would be required to match the lower pricing under the Master Agreement and make it available only to the individual Public Agency.
- (iii) Deviating Buying Patterns. Occasionally U.S. Communities and Supplier may interact with a Public Agency that has a buying pattern or terms and conditions that considerably deviate from the normal Public Agency buying pattern and terms and conditions, and causes Supplier's pricing under the Master Agreement to be higher than an alternative contract held by Supplier. This could be created by a unique end-user preference or requirements. In the event that this situation occurs, Supplier may address the issue by lowering the price under the Master Agreement on the item(s) causing the large deviation for that Public Agency. Supplier would not be required to lower the price for other Public Agencies.

SUPPLIER QUALIFICATIONS COMMITMENTS

- (iv) Supplier's Options in Responding to a Third Party Procurement Solicitation. While it is the objective of U.S. Communities to encourage Public Agencies to piggyback on to the Master Agreement rather than issue their own procurement solicitations, U.S. Communities recognizes that for various reasons some Public Agencies will issue their own solicitations. The following options are available to Supplier when responding to a Public Agency solicitation:
- (A) Supplier may opt not to respond to the procurement solicitation. Supplier may make the Master Agreement available to the Public Agency as a comparison to its solicitation responses.
 - (B) Supplier may respond with the pricing, terms and conditions of the Master Agreement. If Supplier is awarded the contract, the sales would be reported as sales under the Master Agreement.
 - (C) If competitive conditions require pricing lower than the standard Master Agreement pricing, Supplier may submit lower pricing through the Master Agreement. If Supplier is awarded the contract, the sales would be reported as sales under the Master Agreement. Supplier would not be required to extend the lower price to other Public Agencies.
 - (D) Supplier may respond to the procurement solicitation with pricing that is higher (net to buyer) than the pricing offered under the Master Agreement. If awarded a contract, Supplier shall still be bound by all obligations set forth in this Section 3.3, including, without limitation, the requirement to continue to advise the awarding Public Agency of the pricing, terms and conditions of the Master Agreement.
 - (E) Supplier may respond to the procurement solicitation with pricing that is higher (net to buyer) than the pricing offered under the Master Agreement and if an alternative response is permitted, Supplier may offer the pricing under the Master Agreement as an alternative for consideration.
- (c) Economy Commitment. Supplier shall demonstrate the benefits, including the pricing advantage, of the Master Agreement over alternative options, including competitive solicitation pricing and shall proactively offer the terms and pricing under the Master Agreement to Public Agencies as a more effective alternative to the cost and time associated with such alternate bids and solicitations.
- (d) Sales Commitment. Supplier shall market the Master Agreement through Supplier's sales force or dealer network that is properly trained, engaged and committed to offering the Master Agreement as Supplier's primary offering to Public Agencies. Supplier's sales force compensation and incentives shall be greater than or equal to the compensation and incentives earned under other contracts to Public Agencies.

**SUPPLIER QUALIFICATIONS
COMMITMENTS**

- (i) Supplier Sales. Supplier shall be responsible for proactive direct sales of Supplier's Products and Services to Public Agencies and the timely follow-up to sales leads identified by U.S. Communities. Use of product catalogs, targeted advertising, direct mail and other sales initiatives are encouraged. All of Supplier's sales materials targeted towards Public Agencies shall include the U.S. Communities logo. U.S. Communities hereby grants to Supplier, during the term of this Agreement, a non-exclusive, revocable, non-transferable, license to use the U.S. Communities name, trademark, and logo solely to perform its obligations under this Agreement, and for no other purpose. Any goodwill, rights, or benefits derived from Supplier's use of the U.S. Communities name, trademark, or logo shall inure to the benefit of U.S. Communities. U.S. Communities shall provide Supplier with its logo and the standards to be employed in the use of the logo. During the term of the Agreement, Supplier grants to U.S. Communities an express license to reproduce and use Supplier's name and logo in connection with the advertising, marketing and promotion of the Master Agreement to Public Agencies. Supplier shall assist U.S. Communities by providing camera-ready logos and by participating in related trade shows and conferences. At a minimum, Supplier's sales initiatives shall communicate that (i) the Master Agreement was competitively solicited by the Lead Public Agency, (ii) the Master Agreement provides the best government pricing, (iii) there is no cost to Participating Public Agencies, and (iv) the Master Agreement is a non-exclusive contract.
- (ii) Branding and Logo Compliance. Supplier shall be responsible for complying with the U.S. Communities branding and logo standards and guidelines. Prior to use by Supplier, all U.S. Communities related marketing material must be submitted to U.S. Communities for review and approval.
- (iii) Sales Force Training. Supplier shall train its national sales force on the Master Agreement and U.S. Communities program. U.S. Communities shall be available to train regional or district managers and generally assist with the education of sales personnel.
- (iv) Participating Public Agency Access. Supplier shall establish the following communication links to facilitate customer access and communication:
- (A) A dedicated U.S. Communities internet web-based homepage containing:
- (1) U.S. Communities standard logo with Founding Co-Sponsors logos;
 - (2) Copy of original procurement solicitation;
 - (3) Copy of Master Agreement including any amendments;
 - (4) Summary of Products and Services pricing;
 - (5) Electronic link to U.S. Communities' online registration page; and
 - (6) Other promotional material as requested by U.S. Communities.
- (B) A dedicated toll-free national hotline for inquiries regarding U.S. Communities.
- (C) A dedicated email address for general inquiries in the following format: uscommunities@(name of supplier).com.

SUPPLIER QUALIFICATIONS COMMITMENTS

- (v) Electronic Registration. Supplier shall be responsible for ensuring that each Public Agency has completed U.S. Communities' online registration process prior to processing the Public Agency's first sales order.
- (vi) Supplier's Performance Review. Upon request by U.S. Communities, Supplier shall participate in a performance review meeting with U.S. Communities to evaluate Supplier's performance of the covenants set forth in this Agreement.
- (vii) Supplier Content. Supplier may, from time to time, provide certain graphics, media, and other content to U.S. Communities (collectively "Supplier Content") for use on U.S. Communities websites and for general marketing and publicity purposes. Supplier hereby grants to U.S. Communities and its affiliates a non-exclusive, worldwide, perpetual, free, transferrable, license to reproduce, modify, distribute, publically perform, publically display, and use Supplier Content in connection with U.S. Communities websites and for general marketing and publicity purposes, with the right to sublicense each and every such right. Supplier warrants that: (a) Supplier is the owner of or otherwise has the unrestricted right to grant the rights in and to Supplier Content as contemplated hereunder; and (b) the use of Supplier Content and any other materials or services provided to U.S. Communities as contemplated hereunder will not violate, infringe, or misappropriate the intellectual property rights or other rights of any third party

**SUPPLIER QUALIFICATIONS
U.S. COMMUNITIES ADMINISTRATION AGREEMENT**

The Supplier is required to execute the U.S. Communities Administration Agreement unaltered (attached hereto as Appendix D) prior to the award of the U.S. Communities contract. The Agreement outlines the Supplier's general duties and responsibilities in implementing the U.S. Communities contract.

The executed U.S. Communities Administration Agreement is required to be submitted with the supplier's proposal without exception or alteration. Failure to do so will result in disqualification.

SUPPLIER QUALIFICATIONS
SUPPLIER WORKSHEET FOR NATIONAL PROGRAM CONSIDERATION

Suppliers are required to meet specific qualifications. Please respond in the spaces provided after each qualification statement below:

- A. State if pricing for all Products/Services offered will be the most competitive pricing offered by your organization to Participating Public Agencies nationally.
 YES ___ NO ___
- B. Does your company have the ability to provide service to any Participating Public Agencies in the contiguous 48 states, and the ability to deliver service in Alaska and Hawaii?
 YES ___ NO ___
- C. Does your company have a national sales force, dealer network or distributor with the ability to call on Participating Public Agencies in all 50 U.S. states?
 YES ___ NO ___
- D. Did your company have sales greater than \$50 million last year in the United States?
 YES ___ NO ___
- E. Does your company have existing capacity to provide toll-free telephone and state of the art electronic, facsimile and internet ordering and billing?
 YES ___ NO ___
- F. Will your company assign a dedicated Senior Management level Account Manager to support the resulting U.S. Communities program contract?
 YES ___ NO ___
- G. Does your company agree to respond to all agency referrals from U.S. Communities within 2 business days?
 YES ___ NO ___
- H. Does your company maintain records of your overall Participating Public Agencies' sales that you can and will share with U.S. Communities to monitor program implementation progress?
 YES ___ NO ___
- I. Will your company commit to the following program implementation schedule?
 YES ___ NO ___
- J. Will the U.S. Communities program contract be your lead public offering to Participating Public Agencies?
 YES ___ NO ___

Submitted by: _____

 (Printed Name)

 (Signature)

 (Title)

 (Date)

**SUPPLIER QUALIFICATIONS
NEW SUPPLIER IMPLEMENTATION CHECKLIST**

New Supplier Implementation Checklist	Target Completion After Award
1. First Conference Call Discuss expectations Establish initial contact people & roles Outline kickoff plan Establish WebEx training date	One Week
2. Second Conference Call Review Contract Commitments	One Week
3. Administration Agreement Signed Lead Public Agency agreement signed	One Week
4. Supplier Login Established Complete Supplier initiation form Complete Supplier product template Create user account & user ID - Communicate to Supplier	One Week
5. Initial Sr. Management Meeting Review commitments Discuss National Account Manager (NAM) role & staff requirements Discuss reporting process & requirements Review kickoff plan Determine field sales introductory communication plan	Two Weeks
6. Initial NAM & Staff Training Meetings Discuss expectations, roles & responsibilities Introduce and review web-based tools Discuss sales organization & define roles Review with NAM Review process & expectations with NAM and lead referral person Discuss marketing plan and customer communication strategy Discuss Admin process/expectations & provide admin support training	Two Weeks
7. Review Top 10 Local Government Contracts Determine strategies with NAM	Two Weeks
8. Program Contact Requirements Supplier contacts communicated to U.S. Communities Staff Dedicated email Dedicated toll free number Dedicated fax number	Two Weeks
9. Web Development Initiate IT contact Website construction Website final edit Product upload to U.S. Communities site	Two Weeks Three Weeks Four Weeks Four Weeks

**SUPPLIER QUALIFICATIONS
NEW SUPPLIER IMPLEMENTATION CHECKLIST**

10. Sales Training & Roll Out	
Regional Manager (RM) briefing - Coordinate with NAM	One Week
Initial remote WebEx training for all sales - Coordinate with NAM	Two Weeks
Top 10 metro areas - Coordinate with NAM & RM	Four Weeks
Initiate contact with Advisory Board (AB) members	Four Weeks
Training plan for other metros	
11. Marketing	
General announcement	
1 Page Summary with Supplier contacts	
Branding of program	
Supplier handbook	
Announcement to AB and Sponsors	
12. Green Initiative	
Identify Green Products	Two Weeks
- Certifications	
- New product identification	
Identify green expert	
Green reporting	Six Weeks
Upload product to U.S. Communities website	Four Weeks
- Product description	
- Picture	
- SKU	
Green marketing material	Six Weeks
- Approved by U.S. Communities	
- Printed/ Images	
- Articles/ Best Practices/ Supplier internal green practices	
- Workshops	
- Green tradeshow	
- 3rd Party green vendors	

SUPPLIER INFORMATION

Please respond to the following requests for information about your company:

COMPANY

1. Total number and location of sales persons employed by your company in the United States;

Example:

NUMBER OF SALES REPRESENTATIVES	CITY	STATE
13	Phoenix	AZ
6	Tucson	AZ
10	Los Angeles	CA
12	San Francisco	CA
6	San Diego	CA
5	Sacramento	CA
3	Fresno	CA
	Etc.	Etc.
Total: 366		

2. Number and location of manufacturing facilities in the United States and Canada;
3. Number and location of distribution outlets in the United States and Canada (if applicable);
4. Number and location of support centers (if applicable);
5. Annual sales for 2009, 2010 and 2011 in the United States; Sales reporting should be segmented into the following categories:

SUPPLIER ANNUAL SALES IN THE UNITED STATE FOR 2009, 2010, AND 2011			
Segment	2009 Sales	2010 Sales	2011 Sales
Cities			
Counties			
K-12 (Pubic/Private)			
Higher Education (Public/Private)			
States			
Other Public Sector and Nonprofits			
Federal			
Private Sector			
Total Supplier Sales			

6. Submit your current Federal Identification Number and latest Dun & Bradstreet report.
7. Provide a list with contact information of your company's ten largest public agency customers. U.S. Communities Advisory Board Members are to be excluded from the list provided. Provide a list with contact information of five public agency customers that your company has lost in the last twelve months.
8. Provide 3 references in Attachment C of public agencies where products or services of similar size and scope have been performed in the last 12 months.

SUPPLIER INFORMATION

DISTRIBUTION

1. Describe how your company proposes to distribute the Products nationwide.
2. Identify all other companies that will be involved in processing, handling or shipping the Product to the end user.
3. State the effectiveness of the proposed distribution in providing the lowest cost to the end user.
4. Provide the number, size and location of your company's distribution facilities, warehouses and dealer network as applicable.
5. Describe your company's ability to do business with dealer organizations that are either small or MWBE businesses as defined by the Small Business Administration.
6. State the company's standard delivery time, any options for expediting delivery and return policies.
7. State restocking fees, if any, for products returned.

MARKETING

1. Outline your company's plan for marketing the Products to state and local government agencies nationwide.
2. Explain how your company will educate its national sales force about the Master Agreement.
3. Explain how your company will market and transition the Master Agreement into the primary offering to Participating Public Agencies.
4. Explain how your company plans to market the Master Agreement to existing government customers and transition these customers to the Master Agreement. Please provide the amount of purchases of existing public agency clients that your company will transition to the U.S. Communities contract for the initial three years of the contract in the following format within your proposal.
 - a. \$ _____ .00 will be transitioned in year one.
 - b. \$ _____ .00 will be transitioned in year two.
 - c. \$ _____ .00 will be transitioned in year three.
5. Explain how your company proposes to resolve any complaints, issues or challenges.
6. Please submit the resume of the person your company proposes to serve as the National Accounts Manager. Also provide the resume for each person that will be dedicated full time to U.S. Communities account management along with key executive personnel that will be supporting the program.

PRODUCTS

1. Provide a description of the Products and Services to be provided by the major product category set forth in the General Definition of Products and Services of the RFP. The primary objective is for each supplier to provide its complete product and service offerings so that Participating Public Agencies may order a range of product as appropriate for their needs.
2. Describe any special programs that your company offers that will improve customers' ability to access Products, on-time delivery or other innovative strategies.
3. State backorder policy. Do you fill or kill order and require Agency to reorder if item is backordered?
4. Describe the capacity of your company to broaden the scope of the contract and keep the product offerings current and ensure that latest products, standards and technology for Systems Furniture, Freestanding Furniture, Seating, Filing Equipment and Related Products, Support Services and Solutions.

SUPPLIER INFORMATION

QUALITY

1. Describe your company's quality control processes from manufacture through delivery and installation.
2. What testing methodologies do you use to ensure compliance with company specifications and industry standards?
3. Describe your problem escalation process.
4. How are customer complaints measured and categorized? What processes are in place to know that a problem has been resolved?
5. Describe and provide any product or service warranties.

ADMINISTRATION

1. Describe your company's capacity to employ EDI, telephone, ecommerce, with a specific proposal for processing orders under the Master Agreement. State which forms of ordering allow the use of a procurement card and the accepted banking (credit card) affiliation.
2. Describe your company's internal management system for processing orders from point of customer contact through delivery and billing. Please state if you use a single system or platform for all phases of ordering, processing, delivery and billing.
3. Describe your company's ecommerce capabilities, including details about your ability to create punch out sites and accept orders electronically (cXML, OCI, etc.). Please detail where you have integrated with a public agency's ERP (PeopleSoft, Lawson, Oracle, SAP, etc.) system in the past and include some details about the resources you have in place to support these integrations. List, by ERP provider, the following information: name of public agency, ERP system used, "go live" date, net sales per calendar year since "go live", and percentage of agency sales being processed through this connection.
4. Describe your company's implementation and success with existing multi-state cooperative purchasing programs, if any, and provide the entity's name(s), contact person(s) and contact information as reference(s).
5. Describe the capacity of your company to report monthly sales under the Master Agreement by Participating Public Agency within each U.S. state.
6. Describe the capacity of your company to provide management reports, i.e. commodity histories, procurement card histories, green spend, etc. for each Participating Public Agency.
7. Please provide any suggested improvements and alternatives for doing business with your company that will make this arrangement more cost effective for your company and Participating Public Agencies.

NATIONAL STAFFING PLAN

A national staffing plan is required which describes the Supplier's proposed staff distribution to accomplish this work. The staffing plan should indicate a chart that partitions the time commitment of each professional staff member across the proposed tasks and a timeline for the project. It is mandatory that this section identify the key personnel who are to work on the project, their relationship to the contracting organization, and amount of time to be devoted to the project.

SUPPLIER INFORMATION**ENVIRONMENTAL**

1. Provide a brief description of any company environmental initiatives.
2. What is your company's environmental strategy?
3. What is your investment in being an environmentally preferable product leader?
4. Do you have any resources dedicated to your environmental strategy? Please describe.
5. Describe your company's process for defining green products or sustainable processes.
6. Provide documentation on the recycled and recyclable materials in each of your proposed products.
7. Provide certifications demonstrating that products are tested for sustainability.
8. Describe your company's efforts to reduce packaging and minimize environmental footprint in the shipping process.
9. What innovative programs have you implemented to make your products more sustainable?

ADDITIONAL INFORMATION

Please use this opportunity to describe any/all other features, advantages and benefits of your organization that you feel will provide additional value and benefit to a Participating Public Agency.

FAIRFAX COUNTY SPECIAL PROVISIONS

1. SCOPE OF CONTRACT:

- 1.1 The purpose of this Request for Proposal is to solicit sealed proposals to establish a cooperative contract or contracts through competitive negotiation for Systems Furniture, Freestanding Furniture, Seating, Filing Equipment, and Related Products and Support Services and Solutions for the County of Fairfax, Virginia and on behalf of all states, local governments, school districts, and higher education institutions in the United States of America, and other governmental agencies and nonprofit organizations.

2. PRE-PROPOSAL CONFERENCE:

- 2.1. A pre-proposal conference will be held on July 2, 2012 at 1:30 P.M. local time in the Fairfax County Government Center, 12000 Government Center Parkway, Rooms 9 and 10, Fairfax, Virginia. Attendees requiring special services are asked to provide their requirements to the Department of Purchasing and Supply Management ADA representative at (703) 324-3201 or TTY 1-800-828-1140. Please allow seven (7) working days in advance of the event to make the necessary arrangements.
- 2.2. The purpose of the pre-proposal conference is to give potential Offerors an opportunity to ask questions and to obtain clarification about any aspect of this Request for Proposal. Offerors may submit any questions pertaining to the RFP, in writing, prior to the pre-proposal conference to George.Bright@fairfaxcounty.gov.

3. CONTRACT PERIOD AND RENEWAL:

- 3.1. This contract will begin on January 1, 2013, or date of award, whichever is later, and terminate on December 31, 2016. Fairfax County reserves the right to renew this contract for four (4) years, one (1) year at a time.
- 3.2. The obligation of the County to pay compensation due the contractor under the contract or any other payment obligations under any contract awarded pursuant to this Request for Proposal is subject to appropriations by the Fairfax County Board of Supervisors to satisfy payment of such obligations. The County's obligations to make payments during subsequent fiscal years are dependent upon the same action. If such an appropriation is not made for any fiscal year, the contract shall terminate effective at the end of the fiscal year for which funds were appropriated and the County will not be obligated to make any payments under the contract beyond the amount appropriated for payment obligations under the contract. The County will provide the contractor with written notice of non-appropriation of funds within thirty (30) calendar days after action is completed by the Board of Supervisors. However, the County's failure to provide such notice shall not extend the contract into a fiscal year in which sufficient funds have not been appropriated.
- 3.2. Qualified Offerors are encouraged to submit a proposal for Systems Furniture, Freestanding Furniture, Seating, Filing Equipment and Related Products, Support Services and Solutions.

4. TECHNICAL PROPOSAL INSTRUCTIONS:

- 4.1. The Offeror must submit the Technical Proposal in a separate binder containing the following information. This information will be considered the minimum content of the proposal. Proposal contents shall be arranged in the same order and identified with headings as presented herein. It is required that ten (10) copies of the technical proposal be provided in CD or thumb drive format. The Offeror must include a notarized statement that the CD or thumb drive version is a true copy of the printed version.

Electronic/soft copies submitted must be certified free of viruses, malware, Trojans, worms, rootkits, spyware, adware, etc. Those who submit electronic/soft copies that contain viruses, malware, Trojans, worms, rootkits, spyware, adware, etc. may be liable for resulting damages.

FAIRFAX COUNTY SPECIAL PROVISIONS

- 4.2. The Offeror must submit the Technical Proposal in a separate binder containing the following information divided by tabs:

Tab 1 – COVER LETTER: The cover letter will provide a brief history of the Offeror and its organization. The letter will indicate the principal or officer of the Offeror organization who will be the County's primary point of contact during negotiations. This individual must have the authority to negotiate all aspects on the scope of services and provisions on behalf of the Offeror. An officer authorized to bind the Offeror to the terms and conditions of this RFP must sign the cover letter transmitting the proposal.

Tab 2 – EXECUTIVE SUMMARY: The Offeror will provide an Executive Summary that presents in brief, concise terms a summary level description of the contents of the Proposal.

Tab 3 – OFFEROR PROFILE: The Offeror must provide a profile of its organization and all other companies who will be providing products or services through a dealer or distribution arrangement with the Offeror. At a minimum, the Offeror will provide the following information.

- Name of firm submitting proposal
- Main office address
- If a corporation, when and where incorporated
- Number of years in business
- Total number of employees
- Appropriate Federal, State, and County registration numbers

Tab 4 – OFFEROR INFORMATION

- a. Supplier Qualifications (Ref. pages 10-14): Offeror must include a narrative of their understanding and acceptance of the Supplier Commitments.
- b. Completed and signed Supplier Worksheet for National Program Consideration (Ref. page 16).
- c. Supplier Information (Ref. pages 19-22)

Tab 5 – PROJECT STAFFING PLAN

Describe Offeror's project management process. Identify which responsibilities and tasks are assigned to staff at manufacturing facilities, local dealers, local manufacturer's showrooms and subcontractors. Explain how the tasks are effectively coordinated. Include the sequence of the tasks for a typical project. If there are numerous manufacturing facilities please explain how production and shipments are coordinated with a project schedule.

Tab 6 - STATEMENT OF QUALIFICATIONS

The Statement of Qualifications must include a description of organizational and staff experience, and resumes of proposed staff.

- a. Organizational and Staff Experience: Offerors must describe their qualifications and experience to perform the work described in this Request for Proposal. Information about experience should include direct experience with the specific subject matter.
- b. References: Provide three (3) references in Attachment C of public agencies where products or services of similar size and scope have been performed in the last twelve (12) months. References must include organization names, addresses, names of contact persons, and telephone numbers for such references.
- c. Personnel: The manufacturing staff and dealer network staff who may be assigned direct work during this contract should be identified. Information is required which will show the composition of the work group, its specific qualifications, and recent relevant experience. Special mention shall be made of direct technical supervisors and key technical personnel, and approximate percentage of the total time each will be available for this contract.

FAIRFAX COUNTY SPECIAL PROVISIONS

Tab 7 – FINANCIAL STATEMENTS

Offeror must provide detailed, audited income statements and balance sheets from four of the most recent reporting periods.

Tab 8 – APPENDIX B DOCUMENTS

- a. Offeror Data Sheet
- b. Business, Professional and Occupational License

Tab 9 – U.S. COMMUNITIES ADMINISTRATION AGREEMENT, signed unaltered

5. CONSULTATION SERVICES:

- 5.1. The contractor's staff must be available for consultation with County staff on an as-needed basis between 8:00 AM and 5:00 PM, Eastern Time, Monday through Friday.

6. COST PROPOSAL INSTRUCTIONS:

- 6.1. The Offeror must submit a cost proposal in a separate binder, clearly marked, fully supported by cost and pricing data adequate to establish the reasonableness of the proposed fee (see Price Sheet – Attachment A).

It is required that ten (10) copies of the cost proposal be provided in CD or thumb drive format. The Offeror must include a notarized statement that the CD or thumb drive version is a true copy of the printed version.

- a. Provide the pricing using a **fixed percentage (%)** discount off a MANUFACTURER PRICE LIST or other objectively verifiable criteria.
- b. Provide the reference to the standard index or other objective criteria used to determine pricing of each Product category and state why this is most advantageous to Participating Public Agencies. **Copies of the relevant price lists must be included in the Cost Proposal.**
- c. Discounts will be quoted on the basis of:
 1. DROP SHIP: All deliveries shall be delivered to the site. Purchaser is responsible for unloading.
 2. INSIDE DELIVERY: All deliveries shall be delivered to the site and unloaded.
 3. BASIC INSTALLATION: Basic installation includes inside delivery, uncrating, assembly, installation, removal of all debris from premises, installation documents and the bill of materials per the purchaser's approved plan and specifications.
 4. EXPANDED SERVICE INSTALLATION: Expanded service installation includes basic installation; field measurements surveyed, documented and coordinated; electrical and telecommunication/data in-feed locations are surveyed, documented and coordinated; attend required coordination meetings with purchaser and other contractors; and creation and implementation of punch list by project manager.
 5. NORMAL HOURS: Normal hours are defined as 7:00 am – 5:00 pm local time.
 6. AFTER HOURS: After hours are defined as evenings, weekends and holidays.
- d. Installation may be priced by region, zone or other categorization provided pricing is submitted as an hourly rate. Basic and Expanded Service installation must be priced.

FAIRFAX COUNTY SPECIAL PROVISIONS

- e. Pricing for installation and services such as design, project management, asset management, refurbishment and other services should be priced at an hourly rate. An hourly rate range is acceptable.
 - f. Storage should be priced at a monthly rate or other recommended fixed rate(s).
 - g. Detail any additional pricing incentives or rebates that may be available such as for large volume purchase by Participating Public Agencies.
 - h. Provide pricing for any additional related products, services and solutions offered.
- 6.2 The Offeror must submit pricing for the Sample Project provided in Attachment B. Pricing should be based on pricing quoted in Attachment A. The Sample Project will be used for evaluation purposes only.
- a. To obtain the Sample Project in a software format other than what is provided in Attachment B, contact the following person:

Jean Walker-White
 Department of Facilities Management
Jean.walker@fairfaxcounty.gov

7. PRICING:

- 7.1. The subsequent contract will be a firm-fixed price agreement. The fee(s) will remain firm and will include all charges that may be incurred in fulfilling the requirements of the contract during the first 365 days. Changes in cost for any subsequent contract years may be based on the Consumer Price Index (CPI-U), U.S. City Averages, or other relevant indices.
- 7.2. The request for a change in the unit price shall include as a minimum, (1) the cause for the adjustment; (2) proposed effective date; and, (3) the amount of the change requested with documentation to support the requested adjustment (i.e., appropriate Bureau of Labor Statistics, Consumer Price Index (CPI-U), change in manufacturer's price, etc.).
- 7.3. Price decreases shall be made in accordance with paragraph 43 of the General Conditions & Instructions to Offerors. (Appendix A)
- 7.4. Prices/discounts shall be F.O.B. destination.
- 7.5. It is the vendor's responsibility to provide the County and Participating Public Agencies with an up-to-date price list and any necessary brochures, finish material samples or related materials at no charge for the duration of the contract.

8. TRADE SECRETS/PROPRIETARY INFORMATION:

- 8.1. Trade secrets or proprietary information submitted by an Offeror in connection with a procurement transaction shall not be subject to public disclosure under the Virginia Freedom of Information Act; however, Offerors must invoke the protections of this section prior to or upon submission of the data or other materials.
- 8.2. The Offeror must identify the data or other materials to be protected and state the reasons why protection is necessary. Disposition of material after award(s) should be stated by the Offeror.

FAIRFAX COUNTY SPECIAL PROVISIONS

9. CONTACT FOR CONTRACTUAL MATTERS:

- 9.1 All communications and requests for information and clarifications shall be directed to the following procurement official:

George Bright, CPPB, Contract Specialist
 Department of Purchasing and Supply Management
 Telephone: (703) 324-3215
 E-mail: George.bright@fairfaxcounty.gov

- 9.2 No attempt shall be made by any Offeror to contact members of the Selection Advisory Committee (SAC) about this procurement (see paragraph 13.3).

10. SUBMISSION OF PROPOSAL:

- 10.1. One (1) original (duly marked) and ten (10) copies of the Technical proposal, and one (1) original (duly marked) and ten (10) copies of the Cost proposal shall be delivered to the following address in sealed envelopes or packages with the proposal number, title and the Offerors name and address on the outside. In addition, ten (10) copies of the Technical proposal and ten (10) copies of the Cost proposal shall be provided in a CD or thumb drive format. The Offeror must include a notarized statement that the CD or thumb drive version is a true copy of the printed version. Electronically stamped delivery receipts are available.

Department of Purchasing and Supply Management
 12000 Government Center Parkway, Suite 427
 Fairfax, Virginia 22035-0013
 Telephone: 703-324-3201

- 10.2. Offerors are reminded that changes to the request for proposal, in the form of addenda, are often issued between the issue date and within three (3) days before the due date of the solicitation. All addenda **MUST** be signed and submitted to the Department of Purchasing and Supply Management, 12000 Government Center Parkway, Suite 427, Fairfax, VA 22035 before the due date/time or must accompany the proposal. Notice of addenda will be posted on eVA and the DPSM current solicitation webpage. It is the Offeror's responsibility to monitor the web page for the most current addenda at www.fairfaxcounty.gov/dpsm/solic/htm.
- 10.3. It is the Offeror's responsibility to clearly identify and to describe the services being offered in response to the Request for Proposal. Offerors are cautioned that organization of their response, as well as thoroughness is critical to the County's evaluation process. The RFP forms must be completed legibly and in their entirety, and all required supplemental information must be furnished and presented in an organized, comprehensive and easy to follow manner.
- 10.4. Unnecessarily elaborate brochures of other presentations beyond that sufficient to present a complete and effective proposal is not desired. Elaborate artwork, expensive paper, bindings, visual and other presentation aids are not required. The County encourages the use of recycled paper, therefore it is urged that proposals be submitted on paper made from or with recycled content and be printed on both sides.
- 10.5. Each original and set of the ten (10) copies of the proposal shall consist of:
- a. Cover sheet (DPSM32)
 - b. Technical proposal as required in the Special Provisions, paragraph 4 **TECHNICAL PROPOSAL INSTRUCTIONS**.
 - c. Cost proposal as required in the Special Provisions paragraph 6, **COST PROPOSAL INSTRUCTIONS**. (Attachments A and B should be included in the Cost proposal).

FAIRFAX COUNTY SPECIAL PROVISIONS

- 10.6 By executing the cover sheet (DPSM32), Offeror acknowledges that they have read this Request for Proposal, understand it, and agree to be bound by its terms and conditions. Proposals may be submitted by mail or delivered in person.
- 11. LATE PROPOSALS:**
- 11.1 Proposals received in the Office of the County Purchasing Agent after the date and time prescribed shall not be considered for contract award and shall be returned to the Offeror.
- 12. PERIOD THAT PROPOSALS REMAIN VALID:**
- 12.1 Proposals will remain valid for a period of one-hundred and twenty days (120) calendar days after the date specified for receipt of proposals.
- 13. BASIS FOR AWARD:**
- 13.1 This Request for Proposal is being utilized for competitive negotiation. Under the competitive negotiation process, a contract may be awarded to the responsible Offeror whose proposal is determined to be the most advantageous to the County, taking into consideration price and the evaluation factors set forth in the Request for Proposal. The County reserves the right to make multiple awards as a result of this solicitation.
- 13.2 A Selection Advisory Committee has been established to review and evaluate all proposals submitted in response to this Request for Proposal. The Committee shall conduct a preliminary evaluation of all proposals on the basis of the information provided with the proposal, and the evaluation criteria listed below. Based upon this review, the cost proposals of the highest rated Offeror(s) will then be reviewed.
- 13.3 No Offeror, including any of their representatives, subcontractors, affiliates and interested parties, shall contact any member of the Selection Advisory Committee or any person involved in the evaluation of the proposals. Selection Advisory Committee members will refer any and all calls related to this procurement to the procurement official named in 9.1 above. Failure to comply with this directive may, at the sole discretion of the County, result in the disqualification of an Offeror from the procurement process.
- 13.4 Based on the results of the preliminary evaluation, the highest rated Offeror(s) may be invited by the County Purchasing Agent to make oral presentations to the Selection Advisory Committee. This committee will then conduct a final evaluation of the proposals. Selection shall be made of two or more Offerors deemed to be fully qualified and best suited among those submitting proposals, on the basis of the factors involved in the Request for Proposal, including price if so stated in the Request for Proposal. Negotiations shall then be conducted with each of the Offerors so selected. After negotiations have been conducted with each Offeror so selected, the County shall select the Offeror which, in its opinion, has made the best proposal, and shall award the contract to that Offeror.
- 13.5 Should the County determine in writing and in its sole discretion that only one Offeror is fully qualified, or that one Offeror is clearly more highly qualified than the others under consideration, a contract may be negotiated and awarded to that Offeror. The Committee will make appropriate recommendations to the County Executive and Board of Supervisors, if appropriate, prior to actual award of contract.

FAIRFAX COUNTY SPECIAL PROVISIONS

13.6 Proposal Evaluation Criteria

The following factors will be considered in the award of this contract:

- A. **PROVEN EXPERIENCE** of the company's success in providing Systems Furniture, Freestanding Furniture, Seating, Filing Equipment and Related Products, Support Services and Solutions on nationwide and local basis in a timely manner.
 - B. Depth of response to **TECHNICAL PROPOSAL INSTRUCTIONS** (Ref. Special Provisions, paragraph 4).
 - C. Depth of response to **COST PROPOSAL INSTRUCTIONS** (Ref. Special Provisions, paragraph 6).
 - D. Depth of Response to **SUPPLIER QUALIFICATIONS** and **SUPPLIER INFORMATION**.
- 13.7 The County Purchasing Agent may arrange for discussions with firms submitting proposals, if required, for the purpose of obtaining additional information or clarification.
- 13.8 Offerors are advised that, in the event of receipt of an adequate number of proposals, which, in the opinion of the County Purchasing Agent, require no clarifications and/or supplementary information, such proposals may be evaluated without further discussion. Consequently, Offerors should provide complete, thorough proposals with the Offerors most favorable terms. Should proposals require additional clarification and/or supplementary information, Offerors should submit such additional material in a timely manner.
- 13.9 Proposals which, after discussion and submission of additional clarification and/or supplementary information, are determined to meet the specifications of this Request for Proposal will be classified as "acceptable". Proposals found not to be acceptable will be classified as "unacceptable" and no further discussion concerning same will be conducted.
- 13.10 The County may cancel this Request for Proposal or reject proposals at any time prior to an award, and is not required to furnish a statement of the reasons why a particular proposal was not deemed to be the most advantageous.

14. INSURANCE:

- 14.1 The contractor is responsible for its work and for all materials, tools, equipment, appliances, and property of any and all description used in connection with the project, whether owned by the contractor or by the County. The contractor assumes all risks of direct and indirect damage or injury to any person or property wherever located, resulting from any action, omission, commission or operation under the contract, or in connection in any way whatsoever with the contracted work.
- 14.2 The Contractor shall, during the continuance of all work under the Contract provide the following:
- a. Maintain statutory Worker's Compensation and Employer's Liability insurance in limits of not less than \$100,000 to protect the Contractor from any liability or damages for any injuries (including death and disability) to any and all of its employees, volunteers, or subcontractors, including any and all liability or damage which may arise by virtue of any statute or law in force within the Commonwealth of Virginia, or which may be hereinafter enacted.
 - b. The contractor agrees to maintain Commercial General Liability insurance in the amount of \$1,000,000 per occurrence/aggregate, to protect the contractor, its subcontractors, and the interest of the County, against any and all injuries to third parties, including bodily injury and personal injury, wherever located, resulting from any action or operation under the contract or in connection with contracted work. The General Liability insurance shall also include the Broad Form Property Damage endorsement, in addition to coverage's for explosion, collapse, and underground hazards, where required.

FAIRFAX COUNTY SPECIAL PROVISIONS

- c. The contractor agrees to maintain owned, non-owned, and hired Automobile Liability insurance, in the amount of \$1,000,000 per occurrence/aggregate, including property damage, covering all owned, non-owned borrowed, leased, or rented vehicles operated by the Contractor. In addition, all mobile equipment used by the Contractor in connection with the contracted work will be insured under either a standard Automobile Liability policy, or a Comprehensive General Liability policy.
 - d. The contractor agrees to maintain Professional Liability insurance in the amount of \$1,000,000 per occurrence/aggregate to cover each individual professional staff.
 - e. Liability insurance may be arranged by General Liability and Automobile Liability policies for the full limits required, or by a combination of underlying Liability policies for lesser limits with the remaining limits provided by an Excess or Umbrella Liability policy.
 - f. Rating Requirements:
 - 1. The Contractor agrees to provide insurance issued by companies admitted within the Commonwealth of Virginia, with the Best's Key Rating of at least A: VI.
 - 2. European markets including those based in London, and the domestic surplus lines markets that operate on a non-admitted basis are exempt from this requirement provided that the contractor's broker can provide financial data to establish that a market is equal to or exceeds the financial strengths associated with the A.M. Best's rating of A:VI or better.
 - g. Indemnification: Article 63 of the General Conditions and Instructions to Bidders (Appendix A) shall apply.
 - h. The Contractor will provide an original, signed Certificate of Insurance citing the contract number and such endorsements as prescribed herein, and shall have it filed with the County Purchasing Agent and/or Risk Manager before any work is started.
 - i. If the Contractor delivers services from a County-leased facility, the Contractor is required to carry property insurance on all equipment, to include County-owned installed and maintained equipment used by the contractor while in their care, custody and control for use under this contract.
- 14.3 No change, cancellation, or non-renewal shall be made in any insurance coverage without a forty-five day written notice to the County Purchasing Agent and/or Risk Manager. The Contractor shall furnish a new certificate prior to any change or cancellation date. The failure of the Contractor to deliver a new and valid certificate will result in suspension of all payments until the new certificate is furnished.
- 14.4 Precaution shall be exercised at all times for the protection of persons (including employees) and property.
- 14.5 The County of Fairfax, its employees and officers shall be named as an additional insured in the Automobile, General Liability and Professional Liability policies and it shall be stated on the Insurance Certificate with the provision that this coverage is primary to all other coverage the County may possess.

15. METHOD OF ORDERING:

- 15.1 The County may use two (2) different methods of placing orders from the final contract: Purchase Orders (PO's) and approved County procurement cards.
- 15.2 A Purchase Order (PO) may be issued to the contractor on behalf of the County agency ordering the items/services covered under this contract. An issued PO will become part of the resulting contract. The purchase order indicates that sufficient funds have been obligated as required by Title 15.2-1238 of the Code of the Commonwealth of Virginia.

FAIRFAX COUNTY SPECIAL PROVISIONS

- 15.3 Procurement Card orders and payments may also be made by the use of a Fairfax County or Fairfax County Public Schools "Procurement" Card. The Procurement Card is currently a MasterCard. Contractors are encouraged to accept this method of receiving orders.
- 15.4 Regardless of the method of ordering used, solely the contract and any modification determine performance time and dates.
- 15.5 Performance under this contract is not to begin until receipt of the purchase order, Procurement Card order, or other notification to proceed by the County Purchasing Agent and/or County agency to proceed. Purchase requisitions shall not be used for placing orders.
- 16. REPORTS AND INVOICING:**
- 16.1 The Contractor must maintain all records in compliance with federal and state regulations. The Contractor(s) must submit to each program administrator, monthly statistical reports and an annual tabulated report.
- 16.2 The Contractor must invoice each County department using the final contract separately. Invoices for all users of the contract must meet County requirements, unless otherwise indicated. The Contractor must send each department an itemized monthly invoice (or as agreed to between the parties), which must include the information listed below:
- a. Employee name;
 - b. The name of the County department;
 - c. Date of services
 - d. The type of services; and,
 - e. The itemized cost for each item/service.
- 16.3 County departments must receive monthly invoices by the 10th of each month following the month the Contractor provided the service. In addition, the Contractor will provide each County department a monthly and year-to-date utilization report which lists all information shown above in paragraph 16.2, a-e. The Contractor will mail the invoices and the utilization reports to the individuals identified in the final contract.
- 17. PAYMENTS:**
- 17.1 The County will pay the Contractor based upon completion, acceptance, and approval by the County.
- 18. CHANGES:**
- 18.1 Fairfax County may, at any time, by written order, require changes in the services to be performed by the Contractor. If such changes cause an increase or decrease in the Contractor's cost of, or time required for, performance of any services under this contract, an equitable adjustment shall be made and the contract shall be modified in writing accordingly. The County Purchasing Agent must approve all work that is beyond the scope of this Request for Proposal.
- 18.2 No services for which an additional cost or fee will be charged by the Contractor shall be furnished without the prior written authorization of the Fairfax County Purchasing Agent.
- 19. DELAYS AND SUSPENSIONS:**
- 19.1 The Contractor must give the County Purchasing Agent written notice if Fairfax County fails to provide data or services that are required for contract completion by the Contractor. If, after giving the County Purchasing Agent written notice, the Contractor elects to stop work because the County does not supply data or services, the County will extend the Contractor's time of completion by a period of time reasonably suited for completion of work.

FAIRFAX COUNTY SPECIAL PROVISIONS

- 19.2. The County will pay the Contractor for all work completed to the date of suspension plus all the Contractor's cost related to the delay, omission or any consequent work stoppage by the Contractor and its personnel. The Contractor may continue its work on the other phases of the project with an appropriate extension of time of performance upon delivery of the data or services to be provided by Fairfax County. If the Contractor decides to proceed without the data and services that were to be provided by the County, any error or omission of the Contractor that resulted from the County's omission will not constitute default by the Contractor.

20. ACCESS TO AND INSPECTION OF WORK:

- 20.1. The Fairfax County Purchasing Agent and using agencies will, at all times, have access to the work being performed under this contract wherever it may be in progress or preparation.

21. PROJECT AUDITS:

- 21.1. The Contractor shall maintain books, records and documents of all costs and data in support of the services provided. Fairfax County or its authorized representative shall have the right to audit the books, records and documents of the contractor under the following conditions:
- a. If the contract is terminated for any reason in accordance with the provisions of these contract documents in order to arrive at equitable termination costs;
 - b. In the event of a disagreement between the contractor and the County on the amount due the Contractor under the terms of this contract;
 - c. To check or substantiate any amounts invoiced or paid which are required to reflect the costs of services, or the Contractor's efficiency or effectiveness under this contract; and,
 - d. If it becomes necessary to determine the County's rights and the contractor's obligations under the contract or to ascertain facts relative to any claim against the Contractor that may result in a charge against the County.
- 21.2. These provisions for an audit shall give Fairfax County unlimited access during normal working hours to the Contractor's books and records under the conditions stated above.
- 21.3. Unless otherwise provided by applicable statute, the contractor, from the effective date of final payment or termination hereunder, shall preserve and make available to Fairfax County for a period of three (3) years thereafter, at all reasonable times at the office of the Contractor but without direct charge to the County, all its books, records documents and other evidence bearing on the costs and expenses of the services relating to the work hereunder.
- 21.4. Fairfax County's right to audit and the preservation of records shall terminate at the end of three (3) years as stated herein. The Contractor shall include this "Right of Audit and Preservation of Records" clause in all subcontracts issued by it and they shall require same to be inserted by all lower tier subcontractors in their subcontracts, for any portion of the work.
- 21.5. Should the Contractor fail to include this clause in any such contract or lower tier contract, or otherwise fail to insure Fairfax County's rights hereunder, the Contractor shall be liable to Fairfax County for all reasonable costs, expenses and attorney's fees which Fairfax County may have to incur in order to obtain an audit or inspection of or the restoration of records which would have otherwise been available to Fairfax County from said persons under this clause. Such audit may be conducted by Fairfax County or its authorized representative.

22. DATA SOURCES:

- 22.1. The County will provide the Contractor all available data possessed by the County that relates to this contract. However, the Contractor is responsible for all costs for acquiring other data or processing, analyzing or evaluating County data.

FAIRFAX COUNTY SPECIAL PROVISIONS

23. SAFEGUARDS OF INFORMATION:

- 23.1. Unless approved in writing by the County Purchasing Agent, the Contractor may not sell or give to any individual or organization any information, reports, or other materials given to, prepared or assembled by the Contractor under the final contract.

24. ORDER OF PRECEDENCE:

- 24.1. In the event of conflict, the Acceptance Agreement (provided at contract award) and the Special Provisions of this contract shall take precedence over the General Conditions and Instructions to Bidders, (Appendix A).

25. NEWS RELEASE BY VENDORS:

- 25.1. As a matter of policy, the County does not endorse the products or services of a contractor. News releases concerning any resultant contract from this solicitation will not be made by a contractor without the prior written approval of the County. All proposed news releases will be routed to the Purchasing Agent for review and approval.

26. AMERICANS WITH DISABILITIES ACT REQUIREMENTS:

- 26.1. Fairfax County Government is fully committed to the Americans with Disabilities Act (ADA) which guarantees non-discrimination and equal access for persons with disabilities in employment, public accommodations, transportation, and all County programs, activities and services. Fairfax County government contractors, subcontractors, vendors, and/or suppliers are subject to this ADA policy. All individuals having any County contractual agreement must make the same commitment. Your acceptance of this contract acknowledges your commitment and compliance with ADA.
- 26.2. Fairfax County is committed to a policy of nondiscrimination in all County programs, services, and activities and will provide reasonable accommodations upon request. Bidders requesting special accommodations should call the Department ADA representative at (703) 324-3201 or TTY 1-800-828-1140. Please allow seven (7) working days in advance of the event to make the necessary arrangements.

27. STATE CORPORATION COMMISSION IDENTIFICATION NUMBER:

- 27.1. Pursuant to *Code of Virginia*, §2.2-4311.2 subsection B, a bidder or Offeror organized or authorized to transact business in the Commonwealth pursuant to Title 13.1 or Title 50 is required to include in its bid or proposal the identification number issued to it by the State Corporation Commission (SCC). Any bidder or Offeror that is not required to be authorized to transact business in the Commonwealth as a foreign business entity under Title 13.1 or Title 50 or as otherwise required by law is required to include in its bid or proposal a statement describing why the bidder or Offeror is not required to be so authorized. Any bidder or Offeror that fails to provide the required information may not receive an award.

**ATTACHMENT A
PRICE SHEET**

Product	Manufacturer Discount Percent from List Price (or other objectively verifiable criteria)					
	List Price	Drop Ship	Inside Delivery	Basic Installation	Expanded Installation	Volume Discounts (Use more columns as necessary.)
<i>Insert additional rows as necessary.</i>						
Other Related Products						
<i>Insert additional rows as necessary.</i>						
Additional Services and Solutions	Hourly Rates (A range is acceptable)					
Installation						
After hours installation						
Design						
Project Management						
Asset Management						
Refurbishment						
	Monthly Fee (Include any additional options offered)					
Storage						
Other Related Services and Solutions	Hourly Rates					
<i>Insert additional rows as necessary for any additional services and solutions offered by Supplier.</i>						

Note:

- Drop Ship** price includes product delivery to the site, the purchaser is responsible for unloading.
- Inside Delivery** price includes product delivered to the site and unloaded.
- Basic Installation** price to include inside delivery, uncrating, assembly, installation, removal of all debris from premises, installation documents and the bill of materials per the purchaser's approved plan and specifications.
- Expanded Service Installation** price to include basic installation; field measurements surveyed, documented and coordinated; electrical and tele/data infeed locations are surveyed, documented and coordinated; attend required coordination meetings with purchaser and other contractors; and creation and implementation of punch list by project manager.

ATTACHMENT B
SAMPLE PROJECT

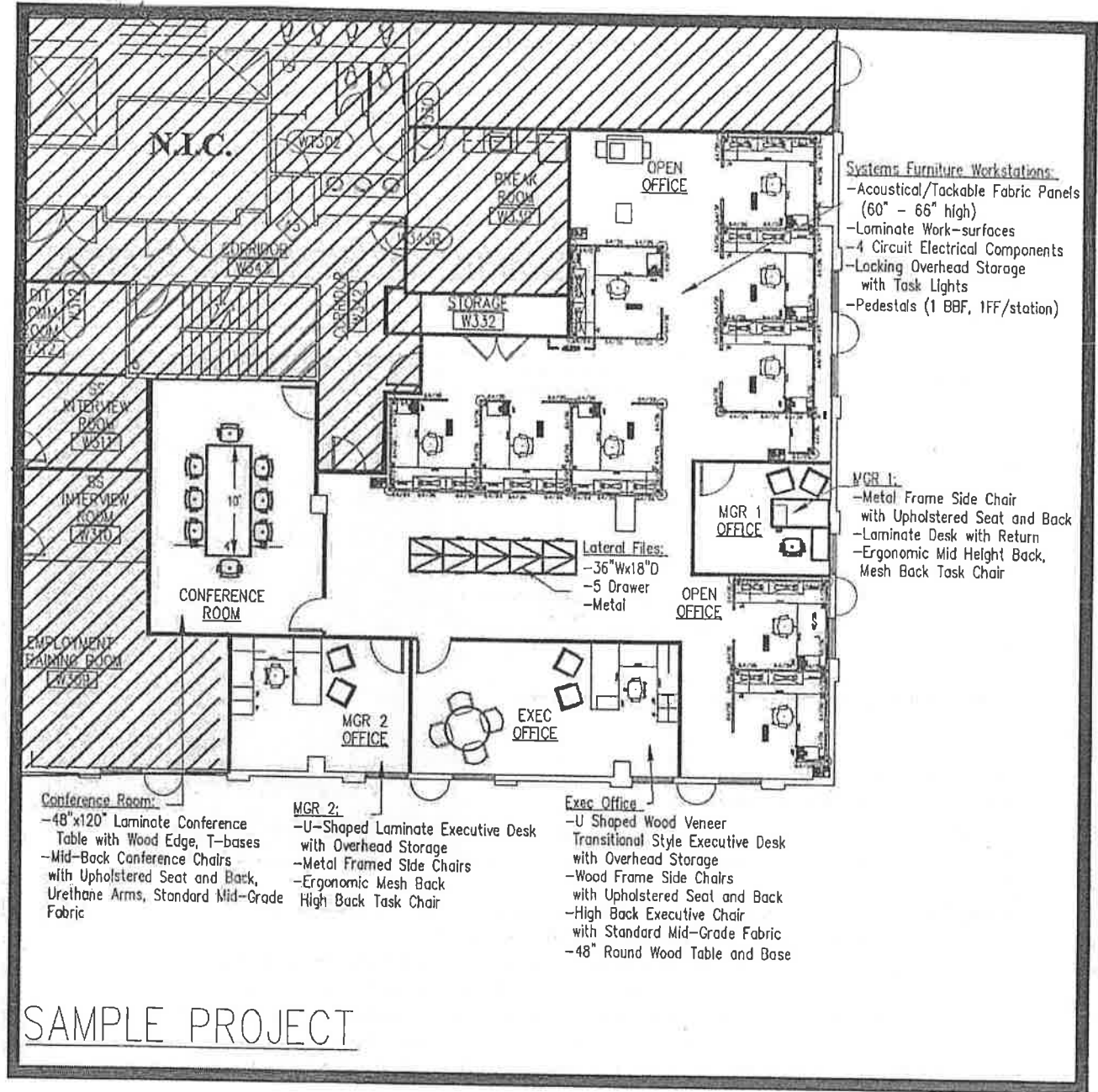

**ATTACHMENT C
REFERENCES**

Provide 3 references of Public Agencies where products or services of similar size and scope have been performed in the last 12 months. If additional space is required, provide on a separate sheet.

Reference 1

Public Agency Name: _____
Contact: _____
Title: _____
Address: _____

Phone : _____
Email: _____

Description of products or services provided:

Total dollar amount: _____

Reference 2

Public Agency Name: _____
Contact: _____
Title: _____
Address: _____

Phone: _____
Email: _____

Description of products or services provided:

Total dollar amount: _____

Reference 3

Public Agency Name: _____
Contact: _____
Title: _____
Address: _____

Phone: _____
Email: _____

Description of products or services provided:

Total dollar amount: _____

COUNTY OF FAIRFAX COMMONWEALTH OF VIRGINIA

GENERAL CONDITIONS AND INSTRUCTIONS TO BIDDERS

(Vendor: The general rules and conditions which follow apply to all purchases and become a definite part of each formal solicitation and resulting contract award issued by the DEPARTMENT OF PURCHASING & SUPPLY MANAGEMENT, unless otherwise specified. Bidders or their authorized representatives are expected to inform themselves fully as to the conditions, requirements, and specifications before submitting bids; failure to do so will be at the bidder's own risk and relief cannot be secured on the plea of error.)

Subject to all State and local laws, policies, resolutions, and regulations and all rules, regulations and limitations imposed by legislation of the Federal Government, bids on all solicitations issued by the DEPARTMENT OF PURCHASING & SUPPLY MANAGEMENT will bind bidders to applicable conditions and requirements herein set forth unless otherwise specified in the solicitation.

1. **AUTHORITY** -The Purchasing Agent has the sole responsibility and authority for negotiating, placing and when necessary modifying every solicitation, contract and purchase order (except for capital construction projects) issued by the County of Fairfax. In the discharge of these responsibilities, the Purchasing Agent may be assisted by assigned buyers. Unless specifically delegated by the County Purchasing Agent, no other County officer or employee is authorized to order supplies or services, enter into purchase negotiations or contracts, or in any way obligate the government of the County of Fairfax for an indebtedness. Any purchase ordered or contract made which is contrary to these provisions and authorities shall be of no effect and void and the County shall not be bound thereby.

2. DEFINITIONS-

AGENCY: Any Department, Agency, Authority, Commission, Board or other unit in the Administrative Service of the County.

BEST VALUE: As predetermined in the solicitation, means the overall combination of quality, price, and various elements of required services that in total are optimal relative to a public body's needs.

BID: The offer of a bidder to provide specific goods or services at specified prices and/or other conditions specified in the solicitation.

BIDDER/OFFEROR: Any individual, company, firm, corporation, partnership or other organization bidding on solicitations issued by the Purchasing Agent and offering to enter into contracts with the County. The term "bidder" will be used throughout this document and shall be construed to mean "offeror" where appropriate.

CONSULTANT SERVICES: Any type of services required by the County, but not furnished by its own employees, which is in its nature so unique that it should be obtained by negotiation on the basis of demonstrated competence and qualification for the type of service required and at fair and reasonable compensation, rather than by competitive sealed bidding.

CONTRACTOR: Any individual, company, firm, corporation, partnership or other organization to whom an award is made by the County.

COUNTY: County of Fairfax.

GOODS: All material, equipment, supplies, printing, and automated data processing/information technology hardware and software.

INFORMALITY: A minor defect or variation of a bid or proposal from the exact requirements of the invitation to bid or the request for proposal which does not affect the price, quality, quantity or delivery schedule for the goods, services or construction being procured.

INVITATION FOR BID (IFB): A request which is made to prospective suppliers (bidders) for their quotation on goods or services desired by the County. The issuance of an IFB will contain or incorporate by reference the specifications and contractual terms and conditions applicable to the procurement.

PROFESSIONAL SERVICES: Any type of professional service performed by an independent contractor within the practice of accounting, actuarial services, architecture, dentistry, land surveying, landscape architecture, law, medicine, optometry, pharmacy, or professional engineering (which shall be procured as set forth in the Code of Virginia §2.2-4301 in the definition of competitive negotiation at paragraph 3 (a), and in conformance with the Fairfax County Purchasing Resolution).

PURCHASING AGENT: The Purchasing Agent employed by the Board of Supervisors of Fairfax County, Virginia.

QUICK QUOTE (QQ): A method of competitive bidding for the purchase or lease of goods, non professional services or for the purchase of insurance, construction, or construction management when the estimated cost thereof shall be less than \$50,000.

REQUEST FOR PROPOSAL (RFP): A request for an offer from prospective offerors which will indicate the general terms which are sought to be procured from the offeror. The RFP will specify the evaluation factors to be used and will contain or incorporate by reference other contractual terms and conditions applicable to the procurement.

RESPONSIBLE BIDDER/OFFEROR: An individual, company, firm, corporation, partnership or other organization having the capability in all respects to perform fully the contract requirements, and also having the moral and business integrity and reliability which will assure good faith performance, and having been prequalified, if required. (Reference paragraph 24, General Conditions and Instructions to Bidders).

GENERAL CONDITIONS AND INSTRUCTIONS TO BIDDERS

RESPONSIVE BIDDER/OFFEROR: An individual, company, firm, corporation, partnership or other organization having submitted a bid which conforms in all material respects to the invitation for bid or request for proposal.

SERVICES: Any work performed by an independent contractor wherein the service rendered does not consist primarily of acquisition of equipment or materials, or the rental of equipment, materials and supplies.

SOLICITATION: The process of notifying prospective bidders that the County wishes to receive bids on a set of requirements to provide goods or services. The notification of County requirements may consist of public advertising (newspaper, County Web Site, or other electronic notification), the mailing of Notices of Solicitation, Invitation for Bid (IFB) or Request for Proposal (RFP), the public posting of notices, issuance of an Open Market Procurement (OMP), or telephone calls to prospective bidders.

STATE: Commonwealth of Virginia.

CONDITIONS OF BIDDING

3. BID FORMS-Unless otherwise specified in the solicitation, all bids shall be submitted on the forms provided, to include the bid Cover Sheet and Pricing Schedule(s), properly signed in ink in the proper spaces and submitted in a sealed envelope or package. The item pages of the Pricing Schedule which do not include any items for which a bid is required need not be included in the submission of a bid.

Should the bid prices and/or any other submissions differ on the copy of the submitted bid, the ORIGINAL copy shall prevail.

4. LATE BIDS & MODIFICATIONS OF BIDS-

- a. Any bid/modification received at the office designated in the solicitation after the exact time specified for receipt of the bid/modification is considered a late bid/modification. A late bid/modification will not be considered for award except under the following conditions only:
 1. It was sent by registered or certified mail not later than the fifth (5th) calendar date prior to the date specified for receipt of the bid/modification; or
 2. The bid/modification was sent by mail and it is determined by the County Purchasing Agent that the late receipt was due solely to mishandling by the County after receipt at the address specified in the solicitation.
- b. If an emergency or unanticipated event or closing interrupts or suspends normal County business operations so that bids cannot be received at the County office designated for receipt of bids by the exact time specified in the solicitation, the due date/time specified for receipt of bids will be deemed to be extended to the same time of day specified in the solicitation on the first work day on which normal County business operations resume.
- c. The official time used for receipt of bids/modifications is the Bid Clerk's time and date stamp clock located in the Department of Purchasing and Supply Management. All bidders are responsible for ensuring all bids/modifications are received prior to the scheduled due date/time.
- d. A late hand-carried bid, or any other late bid not submitted by mail, shall not be considered for award.

5. WITHDRAWAL OF BIDS-

- a. A bidder for a public construction contract, other than a contract for construction or maintenance of public highways, may withdraw his or her bid from consideration if the price bid was substantially lower than the other bids due solely to a mistake therein, provided the bid was submitted in good faith, and the mistake was a clerical mistake as opposed to a judgment mistake, and was actually due to an unintentional arithmetic error or an unintentional omission of a quantity of work, labor or material made directly in the compilation of a bid, which unintentional arithmetic error or unintentional omission can be clearly shown by objective evidence drawn from inspection of original work papers, documents and materials used in the preparation of the bid sought to be withdrawn. If a bid contains both clerical and judgment mistakes, a bidder may withdraw his bid from consideration if the price bid would have been substantially lower than the other bids due solely to the clerical mistake, that was an unintentional arithmetic error or an unintentional omission of a quantity of work, labor or material made directly in the compilation of a bid which shall be clearly shown by objective evidence drawn from inspection of original work papers, documents and materials used in the preparation of the bid sought to be withdrawn. The bidder shall give notice in writing to the Purchasing Agent of his or her claim of right to withdraw his or her bid within two (2) business days after the conclusion of the bid opening procedure and shall submit original work papers with such notice.
- b. A bidder for a contract other than for public construction may request withdrawal of his or her bid under the following circumstances:
 1. Requests for withdrawal of bids prior to opening of such bids shall be transmitted to the County Purchasing Agent in writing.
 2. Requests for withdrawal of bids after opening of such bids but prior to award shall be transmitted to the County Purchasing Agent, in writing, accompanied by full documentation supporting the request. If the request is based on a claim of error, documentation must show the basis of the error. Such documentation may take the form of supplier quotations, vendor work sheets, etc. If bid bonds were tendered with the bid, the County may exercise its right of collection.

GENERAL CONDITIONS AND INSTRUCTIONS TO BIDDERS

- c. No bid may be withdrawn under this paragraph when the result would be the awarding of the contract on another bid of the same bidder or of another bidder in which the ownership of the withdrawing bidder is more than five percent.
 - d. If a bid is withdrawn under the authority of this paragraph, the lowest remaining bid shall be deemed to be the low bid.
 - e. No bidder who is permitted to withdraw a bid shall, for compensation, supply any material or labor to or perform any subcontract or other work agreement for the person or firm to whom the contract is awarded or otherwise benefit, directly or indirectly, from the performance of the project for which the withdrawn bid was submitted.
 - f. If the county denies the withdrawal of a bid under the provisions of this paragraph, it shall notify the bidder in writing stating the reasons for its decision and award the contract to such bidder at the bid price, provided such bidder is a responsible and responsive bidder.
 - g. Work papers, documents, and materials submitted in support of a withdrawal of bids may be considered as trade secrets or proprietary information subject to the conditions of the Virginia Freedom of Information Act.
- 6. ERRORS IN BIDS**-When an error is made in extending total prices, the unit bid price will govern. Erasures in bids must be initiated by the bidder. Carelessness in quoting prices, or in preparation of bid otherwise, will not relieve the bidder. Bidders are cautioned to recheck their bids for possible error. Errors discovered after public opening cannot be corrected and the bidder will be required to perform if his or her bid is accepted.
- 7. MAILING OF BIDS** - All bids and proposals submitted in response to a Fairfax County solicitation shall be submitted in a sealed envelope or package identified with the solicitation number, title, bidder's name and address, and due date/time of opening/closing clearly marked on the outside of such envelope or package.
- 8. COMPLETENESS**-To be responsive, a bid must include all information required by the solicitation.
- 9. ACCEPTANCE OF BIDS/BINDING 90 DAYS**-Unless otherwise specified, all formal bids submitted shall be binding for ninety (90) calendar days following bid opening date, unless extended by mutual consent of all parties.
- 10. CONDITIONAL BIDS**-Conditional bids are subject to rejection in whole or in part.
- 11. BIDS FOR ALL OR PART**-Unless otherwise specified by the County Purchasing Agent or by the bidder, the Purchasing Agent reserves the right to make award on all items in the aggregate or on any of the items on an individual basis, whichever is in the best interest of the County. A bidder may restrict his or her bid to consideration in the aggregate by so stating but shall name a single unit price on each item bid. Any bid in which the bidder names a total price for all the articles without quoting a unit price for each and every separate item may not be considered for award.
- 12. AREA BIDS**-For the purchase and delivery of certain goods and services the County may be divided into Areas (e.g., Areas I, II, III, and IV). When such goods and services are included in the Pricing Schedule, bidders may bid on all areas or an individual area. A map showing the areas of the County will be furnished with the solicitation when required.
- 13. TIME FOR RECEIVING BID**-Bids received prior to the time of opening will be securely kept, unopened. The representative of the Purchasing Agent assigned to open them will decide when the specified time has arrived, and no bid received thereafter will be considered, except as provided in paragraph 4, General Conditions and Instructions to Bidders. No responsibility will attach to the Purchasing Agent or his or her representative for the premature opening of a bid not properly addressed and identified. Unless specifically authorized in the solicitation, telegraphic, electronic, or facsimile bids/modifications will not be considered.
- 14. BID OPENING**-All bids received in response to an Invitation for Bid (IFB) will be opened at the date, time and place specified, read publicly, and made available for inspection as provided in paragraph 68, General Conditions and Instructions to Bidders. Tabulations of bids received are posted on the Department of Purchasing & Supply Management Bulletin Board as well as the County's web site: <http://www.fairfaxcounty.gov/dpsm/solic.htm>. Proposals received in response to a Request for Proposal (RFP) will be made available as provided in paragraph 68, General Conditions and Instructions to Bidders.
- 15. OMISSIONS & DISCREPANCIES**-Any items or parts of any equipment listed in this solicitation which are not fully described or are omitted from such specification, and which are clearly necessary for the completion of such equipment and its appurtenances, shall be considered a part of such equipment although not directly specified or called for in the specifications.
- Should a bidder find discrepancies or ambiguities in, or omissions from, the solicitation, including the drawings and/or specifications, he or she shall notify the Purchasing Agent at least five (5) days prior to the date set for the opening of bids. If necessary, the Purchasing Agent will send a written addendum for clarification to all bidders no later than three (3) days before the date set for opening of bids. Notifications regarding specifications will not be considered if received within five days of the date set for opening of bids.
- 16. RESPONSE TO SOLICITATIONS**-In the event a vendor cannot submit a bid on a solicitation, he or she is requested to return the solicitation cover sheet with an explanation as to why he or she is unable to bid on these requirements.
- 17. BIDDER INTERESTED IN MORE THAN ONE BID**-If more than one bid is offered by any one party, either directly or by or in the name of his or her clerk, partner, or other persons, all such bids may be rejected. A party who has quoted prices on work, materials, or supplies to a bidder is not thereby disqualified from quoting prices to other bidders or firms submitting a bid directly for the work, materials or supplies.

GENERAL CONDITIONS AND INSTRUCTIONS TO BIDDERS

18. TAX EXEMPTION-The County is exempt from the payment of any federal excise or any Virginia sales tax. The price bid must be net, exclusive of taxes. However, when under established trade practice any federal excise tax is included in the list price, a bidder may quote the list price and shall show separately the amount of federal tax, either as a flat sum or as a percentage of the list price, which shall be deducted by the County. Fairfax County's Federal Excise Tax Exemption Number is 54-74-0127K. Contractors located outside the Commonwealth of Virginia are advised that when materials are picked up by the County at their place of business, they may charge and collect their own local/state sales tax. Materials used in the performance of construction contracts are subject to Virginia Sales/Use Tax as described in Section 630-10-27J of the Virginia Retail Sales and Use Tax Regulations.

19. PROHIBITION AGAINST UNIFORM PRICING-The County Purchasing Agent shall encourage open and competitive bidding by all possible means and shall endeavor to obtain the maximum degree of open competition on all purchase transactions using the competitive sealed bidding, competitive negotiation, or open market methods of procurement. In submitting a bid each bidder shall, by virtue of submitting a bid, guarantee that he or she has not been a party with other bidders to an agreement to bid a fixed or uniform price. Violation of this implied guarantee shall render void the bids of participating bidders. Any disclosure to or acquisition by a competitive bidder, in advance of the opening of the bids, of the terms or conditions of the bid submitted by another competitor may render the entire proceedings void and may require re-advertising for bids.

SPECIFICATIONS

20. QUESTIONS CONCERNING SPECIFICATIONS-Any information relative to interpretation of specifications and drawings shall be requested of the Purchasing Agent, in writing, in ample time before the opening of bids. No inquiries, if received by the Purchasing Agent within five (5) days of the date set for the opening of bids, will be given any consideration. Any material interpretation of a specification, as determined by the County Purchasing Agent, will be expressed in the form of an addendum to the specification which will be sent to all prospective bidders no later than three (3) days before the date set for receipt of bids. Oral answers will not be authoritative.

21. BRAND NAME OR EQUAL ITEMS-Unless otherwise provided in the Invitation for bid, the name of a certain brand, make or manufacturer does not restrict bidders to the specific brand, make or manufacturer named; it conveys the general style, type, character, and quality of the article desired, and any article which the County in its sole discretion determines to be the equal of that specified, considering quality, workmanship, economy of operation, and suitability for the purpose intended, shall be accepted.

22. FORMAL SPECIFICATIONS-When a solicitation contains a specification which states no substitutes, no deviation therefrom will be permitted and the bidder will be required to furnish articles in conformity with that specification.

The bidder shall abide by and comply with the true intent of the specifications and not take advantage of any unintentional error or omission, but shall fully complete every part as the true intent and meaning of the specifications and drawings. Whenever the mention is made of any articles, material, or workmanship to be in accordance with laws, ordinances, building codes, underwriter's codes, A.S.T.M. regulations or similar expressions, the requirements of these laws, ordinances, etc., shall be construed as to the minimum requirements of these specifications.

23. FEDERAL SPECIFICATIONS-Any Federal Specifications referred to herein may be obtained from the GSA Federal Supply Service Bureau - Specification Section, 470 East L'Enfant Plaza, S.W., Suite #8100, Washington, D.C. 20407 (Voice: 1-202-619-8925, Fax: 1-202-619-8978).

AWARD

24. AWARD OR REJECTION OF BIDS-The Purchasing Agent shall award the contract to the lowest responsive and responsible bidder complying with all provisions of the IFB, provided the bid price is reasonable and it is in the best interest of the County to accept it. Awards made in response to a RFP will be made to the highest qualified offeror whose proposal is determined, in writing, to be the most advantageous to the County taking into consideration the evaluation factors set forth in the RFP. The Purchasing Agent reserves the right to award a contract by individual items, in the aggregate, or in combination thereof, or to reject any or all bids and to waive any informality in bids received whenever such rejection or waiver is in the best interest of the County. Award may be made to as many bidders as deemed necessary to fulfill the anticipated requirements of Fairfax County. The Purchasing Agent also reserves the right to reject the bid of a bidder deemed to be a non-responsible bidder.

In determining the responsibility of a bidder, the following criteria will be considered:

- a. The ability, capacity and skill of the bidder to perform the contract or provide the service required;
- b. Whether the bidder can perform the contract or provide the service promptly, or within the time specified, without delay or interference;
- c. The character, integrity, reputation, judgment, experience and efficiency of the bidder;
- d. The quality of performance of previous contracts or services;
- e. The previous and existing compliance by the bidder with laws and ordinances relating to the contract or services;
- f. The sufficiency of the financial resources and ability of the bidder to perform the contract or provide the service;
- g. The quality, availability and adaptability of the goods or services to the particular use required;
- h. The ability of the bidder to provide future maintenance and service for the use of the subject of the contract;
- i. The number and scope of the conditions attached to the bid;
- j. Whether the bidder is in arrears to the County on debt or contract or is a defaulter on surety to the County or whether the bidder's County taxes or assessments are delinquent; and
- k. Such other information as may be secured by the County Purchasing Agent having a bearing on the decision to award the contract. If an apparent low bidder is not awarded a contract for reasons of nonresponsibility, the County Purchasing Agent shall so notify that bidder and shall have recorded the reasons in the contract file.

GENERAL CONDITIONS AND INSTRUCTIONS TO BIDDERS

25. NOTICE OF ACCEPTANCE/CONTRACT DOCUMENTS-A written award (or Acceptance Agreement) mailed (or otherwise furnished) to the successful bidder within the time for acceptance specified in the solicitation shall be deemed to result in a binding contract. The following documents which are included in the solicitation shall be incorporated by reference in the resulting contract and become a part of said contract:

- a. County of Fairfax Solicitation Form/Acceptance Agreement (Cover Sheet) and other documents which may be incorporated by reference, if applicable,
- b. General Conditions and Instructions to Bidders,
- c. Special Provisions and Specifications,
- d. Pricing Schedule,
- e. Any Addenda/Amendments/Memoranda of Negotiations

26. TIE-BIDS – If all bids are for the same total amount or unit price (including authorized discounts and delivery times), and if the public interest will not permit the delay of readvertisement for bids, the County Purchasing Agent is authorized to award the contract to the resident Fairfax County tie bidder whose firm has its principal place of business in the County, or if there be none, to the resident Virginia tie bidder, or if there be none, to one of the tie bidders by drawing lots in public; or the County Purchasing Agent may purchase the goods or services in the open market except that the price paid shall not exceed the lowest contract bid price submitted for the same goods or services. The decision of the County to make award to one or more such bidders shall be final.

27. PROMPT PAYMENT DISCOUNT-

- a. Unless otherwise specified in the solicitation, prompt payment discounts requiring payment in less than fifteen (15) days will not be considered in evaluating a bid for award. However, even though not considered in the evaluation, such discounts will be taken if payment is to be made within the discount period.
- b. In connection with any discount offered, time will be computed from the date of delivery of the supplies to the carrier when delivery, inspection and acceptance are at the point of origin; or, from date of delivery, inspection and acceptance at destination; or, from date correct invoice or voucher is received in the office specified by the County, if the latter is later than the date of acceptance. In the event the bidder does not indicate a prompt payment discount, it shall be construed to mean NET 30 days.

For the purpose of earning the discount, payment is deemed to be made as of the date of mailing of the County check or Issuance of an Electronic Funds Transfer.

28. INSPECTION-ACCEPTANCE-For determining acceptance of supplies in accordance with the provisions of the prompt payment discount paragraph, inspection and acceptance shall be accomplished only after examination (including testing) of supplies and services to determine whether the supplies and services conform to the contract requirements. Acceptance shall occur only after receipt and inspection provided such inspection, as appropriate, is accomplished within a reasonable time.

29. DEFINITE BID QUANTITIES-Where definite quantities are specifically stated, acceptance will bind the County to order quantities specified and to pay for, at contract prices, all such supplies or services delivered that meet specifications and conditions of the contract. However, the County will not be required to accept delivery of any balances unordered, as of the contract expiration date, unless the Contractor furnished the Purchasing Agent with a statement of unordered balances not later than ten (10) days after the termination date of the contract.

30. REQUIREMENT BID QUANTITIES-On "Requirement" bids, acceptance will bind the County to pay for, at unit bid prices, only quantities ordered and delivered. Where the County specifies estimated quantities, the Contractor shall not be required to deliver more than ten (10) percent in excess of the estimated quantity of each item, unless otherwise agreed upon.

CONTRACT PROVISIONS

31. TERMINATION OF CONTRACTS-Contracts will remain in force for full periods specified and/or until all articles ordered before date of termination shall have been satisfactorily delivered and accepted and thereafter until all requirements and conditions shall have been met, unless:

- a. Terminated prior to expiration date by satisfactory deliveries of entire contract requirements, or upon termination by the County for Convenience or Cause.
- b. Extended upon written authorization of the Purchasing Agent and accepted by Contractor, to permit ordering of unordered balances or additional quantities at contract prices and in accordance with contract terms.

32. TERMINATION FOR CONVENIENCE-A contract may be terminated in whole or in part by the County in accordance with this clause whenever the County Purchasing Agent shall determine that such a termination is in the best interest of the County. Any such termination shall be effected by delivery to the Contractor at least five (5) working days prior to the termination date of a Notice of Termination specifying the extent to which performance shall be terminated and the date upon which termination becomes effective. An equitable adjustment in the contract price shall be made for completed service, but no amount shall be allowed for anticipated profit on unperformed services.

GENERAL CONDITIONS AND INSTRUCTIONS TO BIDDERS

33. TERMINATION OF CONTRACT FOR CAUSE-

- a. If, through any cause, the Contractor shall fail to fulfill in a timely and proper manner his or her obligations under this contract, or if the Contractor violates any of the covenants, agreements, or stipulations of this contract, in addition to the County's remedies under the contract and all other rights available at law or in equity, the County shall have the right to immediately terminate this contract. Such termination shall be effected by delivering a notice of termination to the Contractor at any time specifying the effective date of such termination. In such event all finished or unfinished documents, data, studies, surveys, drawings, maps, models, and reports prepared by the Contractor under the contract shall, at the option of the County, become its property and the Contractor shall be entitled to receive just and equitable compensation for any satisfactory work completed on such documents.
- b. Notwithstanding the above, the Contractor shall not be relieved of liability to the County for damages sustained by the County by virtue of any breach of contract by the Contractor for the purpose of set off until such time as the exact amount of damages due to the County from the Contractor is determined.

34. **CONTRACT ALTERATIONS**-No alterations in the terms of a contract shall be valid or binding upon the County unless made in writing and signed by the Purchasing Agent or his or her authorized agent.

35. **SUBLETTING OF CONTRACT OR ASSIGNMENT OF CONTRACT FUNDS**-It is mutually understood and agreed that the Contractor shall not assign, transfer, convey, sublet or otherwise dispose of his or her contractual duties to any other person, firm or corporation, without the previous written consent of the Purchasing Agent. If the Contractor desires to assign his or her right to payment of the contract, Contractor shall notify the Purchasing Agent immediately, in writing, of such assignment of right to payment. In no case shall such assignment of contract relieve the Contractor from his or her obligations or change the terms of the contract.

36. **FUNDING**-A contract shall be deemed binding only to the extent of appropriations available to each Agency for the purchase of goods and services.

37. **DELIVERY/SERVICE FAILURES**-Failure of a Contractor to deliver goods or services within the time specified, or within reasonable time as interpreted by the Purchasing Agent, or failure to make replacements/corrections of rejected articles/services when so requested, immediately or as directed by the Purchasing Agent, shall constitute authority for the Purchasing Agent to purchase in the open market articles/services of comparable grade/quality to replace the services, articles rejected, and/or not delivered. On all such purchases, the Contractor shall reimburse the County, within a reasonable time specified by the Purchasing Agent, for any expense incurred in excess of contract prices. Such purchases shall be deducted from the contract quantities if applicable. Should public necessity demand it, the County reserves the right to use or consume articles delivered or services performed which are substandard in quality, subject to an adjustment in price to be determined by the Purchasing Agent.

38. **NON-LIABILITY**-The Contractor shall not be liable in damages for delay in shipment or failure to deliver when such delay or failure is the result of fire, flood, strike, the transportation carrier, act of God, act of Government, act of an alien enemy or by any other circumstances which, in the Purchasing Agent's opinion, are beyond the control of the Contractor. Under such circumstances, however, the Purchasing Agent may, at his or her discretion, cancel the contract.

39. **NEW GOODS, FRESH STOCK**-All Contractors, unless otherwise specifically stated, shall provide new commodities, fresh stock, latest model, design or pack.

40. **NON-DISCRIMINATION**-During the performance of this contract, the Contractor agrees as follows:

- a. The Contractor will not discriminate against any employee or applicant for employment because of race, religion, color, sex, national origin, age, disability, or other basis prohibited by state law relating to discrimination in employment, except where there is a bona fide occupational qualification reasonably necessary to the normal operation of the Contractor. The Contractor agrees to post in conspicuous places, available to employees and applicants for employment, notices setting forth the provisions of this non-discrimination clause.
- b. The Contractor, in all solicitations or advertisements for employees placed by or on behalf of the contractor, will state that such Contractor is an equal opportunity employer.
- c. Notices, advertisements and solicitations placed in accordance with federal law, rule or regulation shall be deemed sufficient for the purpose of meeting the requirements of this section.
- d. The Contractor will include the provisions of the foregoing paragraphs a, b, and c above in every subcontract or purchase order of over \$10,000 so that the provisions will be binding upon each subcontractor or vendor.
- e. Contractor and Subcontractor hereunder shall, throughout the term of this contract, comply with the Human Rights Ordinance, Chapter 11 of the Code of the County of Fairfax, Virginia, as reenacted or amended.

41. SMALL AND MINORITY BUSINESS UTILIZATION

- a. It is the policy of the County of Fairfax as declared by the Fairfax County Board of Supervisors' adoption of a Small and Minority Business Enterprise Program, April 6, 1981, that Fairfax County and its employees undertake every effort to increase opportunity for utilization of small or minority businesses in all aspects of procurement to the maximum extent feasible.
- B Where it is practicable for any portion of the awarded contract to be subcontracted to other suppliers, the contractor is encouraged to offer such subcontracting opportunities to small, women and minority businesses.
- c. Where Federal grants or monies are involved it is the policy of Fairfax County, through its agents and employees, to comply with the requirements set forth in the U.S. Office of Management and Budget Circular No. A-102, uniform administrative requirements for Grants and Cooperative Agreements with State and Local Governments, as they pertain to small and minority business utilization.

GENERAL CONDITIONS AND INSTRUCTIONS TO BIDDERS

42. GUARANTEES & WARRANTIES-All guarantees and warranties required shall be furnished by the Contractor and shall be delivered to the Purchasing Agent before final payment on the contract is made. Unless otherwise stated, manufacturer's standard warranty applies.

43. PRICE REDUCTION-If at any time after the date of the bid the Contractor makes a general price reduction in the comparable price of any material covered by the contract to customers generally, an equivalent price reduction based on similar quantities and/or considerations shall apply to this contract for the duration of the contract period (or until the price is further reduced). Such price reduction shall be effective at the same time and in the same manner as the reduction in the price to customers generally. For purpose of this provision, a "general price reduction" shall mean any horizontal reduction in the price of an article or service offered (1) to Contractor's customers generally, or (2) in the Contractor's price schedule for the class of customers, i.e., wholesalers, jobbers, retailers, etc., which was used as the basis for bidding on this solicitation. An occasional sale at a lower price, or sale of distressed merchandise at a lower price, would not be considered a "general price reduction" under this provision. The Contractor shall submit his or her invoice at such reduced prices indicating on the invoice that the reduction is pursuant to the "Price Reduction" provision of the contract documents. The Contractor in addition will within ten days of any general price reduction notify the Purchasing Agent of such reduction by letter. **FAILURE TO DO SO MAY REQUIRE TERMINATION OF THE CONTRACT.** Upon receipt of any such notice of a general price reduction, all ordering offices will be duly notified by the Purchasing Agent.

The Contractor, if requested, shall furnish, within ten days after the end of the contract period, a statement certifying either (1) that no general price reduction, as defined above, was made after the date of the bid, or (2) if any such general price reductions were made, that as provided above, they were reported to the Purchasing Agent within ten (10) days and ordering offices were billed at the reduced prices. Where one or more such general price reductions were made, the statement furnished by the Contractor shall include with respect to each price reduction (1) the date when notice of any such reduction was issued, (2) the effective date of the reduction, and (3) the date when the Purchasing Agent was notified of any such reduction.

44. CHANGES-Should it become proper or necessary in the execution of this contract to make any change in design, or to make any alterations which will increase the expense, the Purchasing Agent shall determine an equitable adjustment. No payment shall be made to the Contractor for any extra material or services, or of any greater amount of money than stipulated to be paid in the contract, unless some changes in or additions to the contract requiring additional outlay by the Contractor shall first have been expressly authorized and ordered in writing by contract amendment or otherwise furnished by the Purchasing Agent.

45. PLACING OF ORDERS-Orders against contracts will be placed with the Contractor on a Purchase Order (or Procurement Card) executed and released by the Purchasing Agent or his or her designee. The Purchase Order must bear the appropriate contract number and date. Where Blanket Purchase Agreements (BPAs) have been executed and a Blanket Purchase Order has been released by the Purchasing Agent, telephonic orders may be placed directly with the Contractor by authorized personnel in the ordering Agency.

DELIVERY PROVISIONS

46. SHIPPING INSTRUCTIONS - CONSIGNMENT-Unless otherwise specified in the solicitation each case, crate, barrel, package, etc., delivered under the contract must be plainly stenciled or securely tagged, stating the Contractor's name, purchase order number, and delivery address as indicated in the order. Where shipping containers are to be used, each container must be marked with the purchase order number, name of the Contractor, the name of the item, the item number, and the quantity contained therein. Deliveries must be made within the hours of 8:00 AM - 3:00 PM. Deliveries at any other time will not be accepted unless specific arrangements have been previously made with the receiver at the delivery point. No deliveries will be accepted on Saturdays, Sundays and holidays, unless previous arrangements have been made. It shall be the responsibility of the Contractor to insure compliance with these instructions for items that are drop-shipped.

47. RESPONSIBILITY FOR SUPPLIES TENDERED-Unless otherwise specified in the solicitation, the Contractor shall be responsible for the materials or supplies covered by the contract until they are delivered at the designated point, but the Contractor shall bear all risk on rejected materials or supplies after notice of rejection. Rejected materials or supplies must be removed by and at the expense of the Contractor promptly after notification of rejection, unless public health and safety require immediate destruction or other disposal of rejected delivery. If rejected materials are not removed by the Contractor within ten (10) days after date of notification, the County may return the rejected materials or supplies to the Contractor at his or her risk and expense or dispose of them as its own property.

48. INSPECTIONS-Inspection and acceptance of materials or supplies will be made after delivery at destinations herein specified unless otherwise stated. If inspection is made after delivery at destination herein specified, the County will bear the expense of inspection except for the value of samples used in case of rejection. Final inspection shall be conclusive except in regard to latent defects, fraud or such gross mistakes as to amount to fraud. Final inspection and acceptance or rejection of the materials or supplies will be made as promptly as practicable, but failure to inspect and accept or reject materials or supplies shall not impose liability on the County for such materials or supplies as are not in accordance with the specifications.

49. COMPLIANCE-Delivery must be made as ordered and in accordance with the solicitation or as directed by the Purchasing Agent when not in conflict with the bid. The decision of the Purchasing Agent as to reasonable compliance with delivery terms shall be final. Burden of proof of delay in receipt of goods by the purchaser shall rest with the Contractor. Any request for extension of time of delivery from that specified must be approved by the Purchasing Agent, such extension applying only to the particular item or shipment affected. Should the Contractor be delayed by the County, there shall be added to the time of completion a time equal to the period of such delay caused by the County. However, the contractor shall not be entitled to claim damages or extra compensation for such delay or suspension. These conditions may vary for construction contracts. See Special Provisions for the individual solicitation.

50. POINT OF DESTINATION-All materials shipped to the County must be shipped F.O.B. DESTINATION unless otherwise stated in the contract or purchase order. The materials must be delivered to the "Ship to" address indicated on the purchase order.

GENERAL CONDITIONS AND INSTRUCTIONS TO BIDDERS

51. **ADDITIONAL CHARGES**-Unless bought F.O.B. "shipping point" and Contractor prepays transportation, no delivery charges shall be added to Invoices except when express delivery is authorized and substituted on orders for the method specified in the contract. In such cases, difference between freight or mail and express charges may be added to Invoice.

52. **METHOD AND CONTAINERS**-Unless otherwise specified, goods shall be delivered in commercial packages in standard commercial containers, so constructed as to ensure acceptance by common or other carrier for safe transportation to the point of delivery. Containers become the property of the County unless otherwise specified by bidder.

53. **WEIGHT CHECKING**-Deliveries shall be subject to re-weighing over official sealed scales designated by the County. Payments shall be made on the basis of net weight of materials delivered. Normal shrinkage may be allowed in such instances where shrinkage is possible. Net weights only, exclusive of containers or wrapping, shall be paid for by the County.

54. **DEMURRAGE AND RE-SPOTTING**-The County will be responsible for demurrage charges only when such charges accrue because of the County's negligence in unloading the materials. The County will pay railroad charges due to the re-spotting of cars, only when such re-spotting is ordered by the County.

55. **REPLACEMENT**-Materials or components that have been rejected by the Purchasing Agent, in accordance with the terms of a contract, shall be replaced by the Contractor at no cost to the County.

56. **PACKING SLIPS OR DELIVERY TICKETS**-All shipments shall be accompanied by Packing Slips or Delivery Tickets and shall contain the following information for each item delivered:

1. The Purchase Order Number,
2. The Name of the Article and Stock Number (Supplier's),
3. The Fairfax County Identification Number (FCIN), if specified in the order,
4. The Quantity Ordered,
5. The Quantity Shipped,
6. The Quantity Back Ordered,
7. The Name of the Contractor.

Contractors are cautioned that failure to comply with these conditions shall be considered sufficient reason for refusal to accept the goods.

BILLING

57. **BILLING**-Billing for the Fairfax County Public Schools and for County agencies: Unless otherwise specified on the contract or purchase order (PO), invoices are to be submitted, in DUPLICATE, for each purchase order immediately upon completion of the shipment or services. If shipment is made by freight or express, the original Bill of Lading, properly receipted, must be attached to the invoice. Invoices should be mailed to the "BILL TO" address on the PO or to the appropriate address specified in the contract.

PAYMENTS

58. **PAYMENT**-Payment shall be made after satisfactory performance of the contract, in accordance with all of the provisions thereof, and upon receipt of a properly completed invoice. Fairfax County reserves the right to withhold any or all payments or portions thereof for Contractor's failure to perform in accordance with the provision of the contract or any modifications thereto.

59. **PARTIAL PAYMENTS**-Unless otherwise specified, partial payments will be made upon acceptance of materials or services so invoiced if in accordance with completion date. However, up to 5 percent (5%) of the value of the entire order may be retained until completion of contract.

60. **PAYMENT FOR EQUIPMENT, INSTALLATION, AND TESTING**-When equipment requires installation (which shall also be interpreted to mean erection and/or setting up or placing in position, service, or use) and test, and where such installation or testing is delayed, payment may be made on the basis of 50% of the contract price when such equipment is delivered on the site. A further allowance of 25% may be made when the equipment is installed and ready for test. The balance shall be paid after the equipment is tested and found to be satisfactory. If the equipment must be tested, but installation is not required to be made by the Contractor or if the equipment must be installed but testing is not required, payment may be made on the basis of 75% at the time of delivery and the balance shall be paid after satisfactory test or installation is completed.

GENERAL

61. **GENERAL GUARANTY**-Contractor agrees to:

- a. Save the County, its agents and employees harmless from liability of any nature or kind for the use of any copyrighted or uncopyrighted composition; secret process, patented or unpatented; invention; article or appliance furnished or used in the performance of a contract for which the Contractor is not the patentee, assignee, licensee or owner.
- b. Protect the County against latent defective material or workmanship and to repair or replace any damages or marring occasioned in transit or delivery.
- c. Furnish adequate protection against damage to all work and to repair damages of any kind to the building or equipment, to his or her own work or to the work of other contractors, for which his or her workers are responsible.
- d. Pay for all permits, licenses and fees and give all notices and comply with all laws, ordinances, rules and regulations of the County.
- e. Protect the County from loss or damage to County owned property while it is in the custody of the Contractor.

GENERAL CONDITIONS AND INSTRUCTIONS TO BIDDERS

62. SERVICE CONTRACT GUARANTY-Contractor agrees to:

- a. Furnish services described in the solicitation and resultant contract at the times and places and in the manner and subject to conditions therein set forth provided that the County may reduce the said services at any time.
- b. Enter upon the performance of services with all due diligence and dispatch, assiduously press to its complete performance, and exercise therein the highest degree of skill and competence.
- c. All work and services rendered in strict conformance to all laws, statues, and ordinances and the applicable rules, regulations, methods and procedures of all government boards, bureaus, offices and other agents.
- d. Allow services to be inspected or reviewed by an employee of the County at any reasonable time and place selected by the County. Fairfax County shall be under no obligation to compensate Contractor for any services not rendered in strict conformity with the contract.
- e. Stipulate that the presence of a County Inspector shall not lessen the obligation of the Contractor for performance in accordance with the contract requirements, or be deemed a defense on the part of the Contractor for infraction thereof. The Inspector is not authorized to revoke, alter, enlarge, relax, or release any of the requirements of the contract documents. Any omission or failure on the part of the Inspector to disapprove or reject any work or material shall not be construed to be an acceptance of any such defective work or material. Notification of an omission or failure will be documented by the Purchasing Agent.

63. INDEMNIFICATION-Contractor shall indemnify, keep and save harmless the County, its agents, officials, employees and volunteers against claims of injuries, death, damage to property, theft, patent claims, suits, liabilities, judgments, cost and expenses which may otherwise accrue against the County in consequence of the granting of a contract or which may otherwise result therefrom, if it shall be determined that the act was caused through negligence or error, or omission of the Contractor or his or her employees, or that of the subcontractor or his or her employees, if any; and the Contractor shall, at his or her own expense, appear, defend and pay all charges of attorneys and all costs and other expenses arising therefrom or incurred in connection therewith; and if any judgment shall be rendered against the County in any such action, the Contractor shall, at his or her own expense, satisfy and discharge the same. Contractor expressly understands and agrees that any performance bond or insurance protection required by this contract, or otherwise provided by the Contractor, shall in no way limit the responsibility to indemnify, keep and save harmless and defend the County as herein provided.

64. OFFICIALS NOT TO BENEFIT-

- a. Each bidder or offeror shall certify, upon signing a bid or proposal, that to the best of his or her knowledge no Fairfax County official or employee having official responsibility for the procurement transaction, or member of his or her immediate family, has received or will receive any financial benefit of more than nominal or minimal value relating to the award of this contract. If such a benefit has been received or will be received, this fact shall be disclosed with the bid or proposal or as soon thereafter as it appears that such a benefit will be received. Failure to disclose the information prescribed above may result in suspension or debarment, or rescission of the contract made, or could affect payment pursuant to the terms of the contract.
- b. Whenever there is reason to believe that a financial benefit of the sort described in paragraph "a" has been or will be received in connection with a bid, proposal or contract, and that the contractor has failed to disclose such benefit or has inadequately disclosed it, the County Executive, as a prerequisite to payment pursuant to the contract, or at any other time, may require the Contractor to furnish, under oath, answers to any interrogatories related to such possible benefit.
- c. In the event the bidder or offeror has knowledge of benefits as outlined above, this information should be submitted with the bid or proposal. If the above does not apply at time of award of contract and becomes known after inception of a contract, the bidder or offeror shall address the disclosure of such facts to the Fairfax County Purchasing Agent, 12000 Government Center Parkway, Suite 427, Fairfax, Virginia 22035-0013. Relevant Invitation/Request for Proposal Number (see cover sheet) should be referenced in the disclosure.

65. LICENSE REQUIREMENT-All firms doing business in Fairfax County, shall obtain a license as required by Chapter 4, Article 7, of The Code of the County of Fairfax, Virginia, as amended, entitled "Business, Professional and Occupational Licensing (BPOL) Tax." Questions concerning the BPOL Tax should be directed to the Department of Tax Administration, telephone (703) 222-8234 or visit: http://www.fairfaxcounty.gov/dta/business_tax.htm. The BPOL Tax number must be indicated in the space provided on the Cover Sheet, "Fairfax License Tax No." when appropriate.

66. AUTHORIZATION TO CONDUCT BUSINESS IN THE COMMONWEALTH: A contractor organized as a stock or nonstock corporation, limited liability company, business trust, or limited partnership or registered as a registered limited liability partnership shall be authorized to transact business in the Commonwealth as a domestic or foreign business entity if so required by Title 13.1 or Title 50 of the *Code of Virginia* or as otherwise required by law. Any business entity described above that enters into a contract with a Fairfax County pursuant to the Fairfax County Purchasing Resolution shall not allow its existence to lapse or its certificate of authority or registration to transact business in the Commonwealth, if so required under Title 13.1 or Title 50, to be revoked or cancelled at any time during the term of the contract. Fairfax County may void any contract with a business entity if the business entity fails to remain in compliance with the provisions of this section.

67. COVENANT AGAINST CONTINGENT FEES-The Contractor warrants that no person or selling agency has been employed or retained to solicit or secure this contract upon an agreement or understanding for a commission, percentage, brokerage, or contingent fee, except bona fide employees or bona fide established commercial or selling agencies maintained by the Contractor for the purpose of securing business. For violation of this warranty, the County shall have the right to terminate or suspend this contract without liability to the County or in its discretion to deduct from the contract price or consideration, or otherwise recover, the full amount of such commission, percentage, brokerage, or contingent fee.

68. VIRGINIA FREEDOM OF INFORMATION ACT-All proceedings, records, contracts and other public records relating to procurement transactions shall be open to the inspection of any citizen, or any interested person, firm or corporation, in accordance with the Virginia Freedom of Information Act (Reference Section 4.D., of the Fairfax County Purchasing Resolution)

GENERAL CONDITIONS AND INSTRUCTIONS TO BIDDERS**BIDDER/CONTRACTOR REMEDIES****69. INELIGIBILITY-**

- a. Any person or firm suspended or debarred from participation in County procurement shall be notified in writing by the County Purchasing Agent.
 1. The Notice of Suspension shall state the reasons for the actions taken and such decision shall be final unless the person or firm appeals within thirty (30) days of receipt of the Notice by instituting legal action as provided in the Code of Virginia.
 2. The Notice of Debarment shall state the reasons for the actions taken and the decision shall be final unless the person or firm appeals within thirty (30) days of receipt of the notice by instituting legal action as provided in the Code of Virginia.
- b. The County Purchasing Agent shall have the authority to suspend or debar a person or firm from bidding on any contract for the causes stated below:
 1. Conviction for commission of a criminal offense as an incident to obtaining or attempting to obtain a public or private contract or subcontract, or in the performance of such contract or subcontract;
 2. Conviction under state or federal statutes of embezzlement, theft, forgery, bribery, falsification or destruction of records, receiving stolen property, or any other offense indicating a lack of business integrity or business honesty which currently, seriously, and directly affects responsibility as a County contractor;
 3. Conviction under the state or federal antitrust statutes arising out of the submission of bids or proposals;
 4. Violation of contract provisions, as set forth below, of a character which is regarded by the County Purchasing Agent to be so serious as to justify suspension or debarment action:
 - (a) failure without good cause to perform in accordance with the specifications or within the time limit provided in the contract; or
 - (b) a recent record of failure to perform or of unsatisfactory performance in accordance with the terms of one or more contracts; provided, that failure to perform or unsatisfactory performance caused by acts beyond the control of the contractor shall not be considered to be a basis for suspension or debarment;
 5. Any other cause the County Purchasing Agent determines to be so serious and compelling as to affect responsibility as a contractor, such as debarment by another governmental entity for any cause listed herein, or because of prior reprimands;
 6. The contractor has abandoned performance or been terminated for default on any other Fairfax County project;
 7. The contractor is in default on any surety bond or written guarantee on which Fairfax County is an obligee.
- c. If, upon appeal, it is determined that the action taken by the County Purchasing Agent was arbitrary or capricious, or not in accordance with the Constitution of Virginia, statutes or regulations, the sole relief available to the person or firm shall be restoration of eligibility. The person or firm may not institute legal action until all statutory requirements have been met.

70. APPEAL OF DENIAL OF WITHDRAWAL OF BID-

- a. A decision denying withdrawal of a bid submitted by a bidder or offeror shall be final and conclusive unless the bidder appeals the decision within ten (10) days after receipt of the decision by instituting legal action as provided in the Code of Virginia. The bidder or offeror may not institute legal action until all statutory requirements have been met.
- b. If no bid bond was posted, a bidder refused withdrawal of bid under the provisions of Article 2, Section 4 a.9, of the Fairfax County Purchasing Resolution, prior to appealing, shall deliver to the County a certified check or cash bond in the amount of the difference between the bid sought to be withdrawn and the next low bid. Such security shall be released only upon a final determination that the bidder was entitled to withdraw the bid.
- c. If, upon appeal, it is determined that the decision refusing withdrawal of the bid was arbitrary or capricious, the sole relief shall be withdrawal of the bid.

71. APPEAL OF DETERMINATION OF NONRESPONSIBILITY-

- a. Any bidder who, despite being the apparent low bidder, is determined not to be a responsible bidder for a particular County contract shall be notified in writing by the County Purchasing Agent. Such notice shall state the basis for the determination, which shall be final unless the bidder appeals the decision within ten (10) days of receipt of the notice by instituting legal action as provided in the Code of Virginia. The bidder may not institute legal action until all statutory requirements have been met.
- b. If, upon appeal, it is determined that the decision of the County Purchasing Agent was arbitrary or capricious and the award for the particular County contract in question has not been made, the sole relief available to the bidder shall be a finding that the bidder is a responsible bidder for the County contract in question. Where the award has been made and performance has begun, the County may declare the contract void upon a finding that this action is in the best interest of the public. Where a contract is declared void, the performing contractor shall be compensated for the cost of performance up to the time of such declaration. In no event shall the performing contractor be entitled to lost profits.

GENERAL CONDITIONS AND INSTRUCTIONS TO BIDDERS

72. PROTEST OF AWARD OR DECISION TO AWARD-

- a. Any bidder or offeror may protest the award or decision to award a contract by submitting a protest in writing to the County Purchasing Agent, or an official designated by the County of Fairfax, no later than ten (10) days after the award or the announcement of the decision to award, whichever occurs first. Any potential bidder or offeror on a contract negotiated on a sole source or emergency basis who desires to protest the award or decision to award such contract shall submit such protest in the same manner no later than ten days after posting or publication of the notice of such contract as provided in Article 3, Section 4, of the Fairfax County Purchasing Resolution. However, if the protest of any actual or potential bidder or offeror depends in whole or in part upon information contained in public records pertaining to the procurement transaction which are subject to inspection under Article 2, Section 4d of the Fairfax County Purchasing Resolution, then the time within which the protest must be submitted shall expire ten days after those records are available for inspection by such bidder or offeror under Article 2, Section 4d, or at such later time as provided herein. No protest shall lie for a claim that the selected bidder or offeror is not a responsible bidder or offeror. The written protest shall include the basis for the protest and the relief sought. The County Purchasing Agent shall issue a decision in writing within ten (10) days of the receipt of the protest stating the reasons for the action taken. This decision shall be final unless the bidder or offeror appeals within ten (10) days of receipt of the written decision by instituting legal action as provided in the Code of Virginia.
- b. If prior to award it is determined that the decision to award is arbitrary or capricious, then the sole relief shall be a finding to that effect. The County Purchasing Agent shall cancel the proposed award or revise it to comply with the law. If, after an award, it is determined that an award of a contract was arbitrary or capricious, then the sole relief shall be as hereinafter provided. Where the award has been made but performance has not begun, the performance of the contract may be declared void by the County. Where the award has been made and performance has begun, the County Purchasing Agent may declare the contract void upon a finding that this action is in the best interest of the County. Where a contract is declared void, the performing contractor shall be compensated for the cost of performance at the rate specified in the contract up to the time of such declaration. In no event shall the performing contractor be entitled to lost profits.
- c. Pending final determination of a protest or appeal, the validity of a contract awarded and accepted in good faith in accordance with this article shall not be affected by the fact that a protest or appeal has been filed.
- d. An award need not be delayed for the period allowed a bidder or offeror to protest, but in the event of a timely protest, no further action to award the contract will be taken unless there is a written determination that proceeding without delay is necessary to protect the public interest or unless the bid or offer would expire.

73. CONTRACTUAL DISPUTES-

- a. Any dispute concerning a question of fact as a result of a contract with the County which is not disposed of by agreement shall be decided by the County Purchasing Agent, who shall reduce his decision to writing and mail or otherwise forward a copy thereof to the contractor within thirty (30) days. The decision of the County Purchasing Agent shall be final and conclusive unless the contractor appeals within six (6) months of the date of the final written decision by instituting legal action as provided in the Code of Virginia. A contractor may not institute legal action, prior to receipt of the public body's decision on the claim, unless the public body fails to render such decision within the time specified.
- b. Contractual claims, whether for money or other relief, shall be submitted in writing no later than sixty days after final payment; however, written notice of the contractor's intention to file such claim shall have been given at the time of the occurrence or beginning of the work upon which the claim is based. Nothing herein shall preclude a contract from requiring submission of an invoice for final payment within a certain time after completion and acceptance of the work or acceptance of the goods. Pendency of claims shall not delay payment of amounts agreed due in the final payment.

74. **LEGAL ACTION**-No bidder, offeror, potential bidder or offeror, or contractor shall institute any legal action until all statutory requirements have been met.

75. **COOPERATIVE PURCHASING**-The County may participate in, sponsor, conduct or administer a cooperative procurement agreement on behalf of or in conjunction with one or more other public bodies, or public agencies or institutions or localities of the several states, of the United States or its territories, or the District of Columbia, for the purpose of combining requirements to increase efficiency or reduce administrative expenses in any acquisition of goods and services. Except for contracts for professional services, a public body may purchase from another public body's contract even if it did not participate in the request for proposal (RFP) or invitation for bid (IFB), if the RFP or IFB specified that the procurement was being conducted on behalf of other public bodies. Nothing herein shall prohibit the assessment or payment by direct or indirect means of any administrative fee that will allow for participation in any such arrangement.

76. **PROFESSIONAL AFFILIATION**-The Department of Purchasing & Supply Management holds membership in the National Institute of Governmental Purchasing, Inc., a non-profit, educational and technical organization that includes among its goals and objectives the study, discussion, and recommendation of improvements in governmental purchasing and the interchange of ideas and experiences on local state, and national governmental purchasing problems.

GENERAL CONDITIONS AND INSTRUCTIONS TO BIDDERS

77. **DRUG FREE WORKPLACE**-During the performance of a contract, the contractor agrees to (i) provide a drug-free workplace for the contractor's employees; (ii) post in conspicuous places, available to employees and applicants for employment, a statement notifying employees that the unlawful manufacture, sale, distribution, dispensation, possession, or use of a controlled substance or marijuana is prohibited in the contractor's workplace and specifying the actions that will be taken against employees for violations of such prohibition; (iii) state in all solicitations or advertisements for employees placed by or on behalf of the contractor that the contractor maintains a drug-free workplace; and (iv) include the provisions of the foregoing clauses in every subcontract of over \$10,000, so that the provisions will be binding upon each subcontractor or vendor. For the purposes of this section, "drug-free workplace" means a site for the performance of work done in conjunction with a specific contract awarded to a contractor in accordance with this section, the employees of whom are prohibited from engaging in the unlawful manufacture, sale, distribution, dispensation, possession or use of any controlled substance or marijuana during the performance of the contract.

78. **VENUE**: This contract and its terms, including, but not limited to, the parties' obligations under it, the performance due from each party under it, and the remedies available to each party for breach of it, shall be governed by, construed and interpreted in accordance with the laws of the Commonwealth of Virginia. Any jurisdiction's choice of law, conflict of laws, rules, or provisions, including those of the Commonwealth of Virginia that would cause the application of any laws other than those of the Commonwealth of Virginia shall not apply. Any and all disputes, claims and causes of action arising out of or in connection with this contract or any performance hereunder, shall be brought in the applicable court of Fairfax County, Virginia, or in the United States District Court, Eastern District of Virginia, Alexandria Division.

79. **IMMIGRATION REFORM AND CONTROL ACT**: Contractor agrees that it does not, and shall not during the performance of the contract for goods and services in the Commonwealth, knowingly employ an unauthorized alien as defined in the Federal Immigration Reform and Control Act of 1986.

80. **CONTRACTOR NOT TO BENEFIT**: Contractor agrees that the goods and/or services provided to Fairfax County pursuant to this Agreement are for the benefit of Fairfax County and that Contractor shall not undertake any actions or efforts stemming from or related to this Agreement that shall inure to the detriment of Fairfax County. Any information provided to the Contractor for the performance of this Contract shall not be used for any other purpose without the written consent of the Purchasing Agent.

APPROVED:

/s/ David P. Bobzien
COUNTY ATTORNEY

/s/ Cathy A. Muse
COUNTY PURCHASING AGENT

OFFEROR DATA SHEET

NAME OF OFFEROR: _____

ADDRESS: _____

E-MAIL ADDRESS: _____

Name and e-mail addresses of both service and fiscal representatives (Key Personnel) who would handle this account.

Service Representative: _____
Telephone Number: () _____
E-Mail Address: _____

Fiscal Representative: _____
Telephone Number: () _____
E-Mail Address: _____

Payment Address, if different from above:

BUSINESS, PROFESSIONAL AND OCCUPATIONAL LICENSE

All firms located or operating in Fairfax County must obtain a Business, Professional and Occupational License (BPOL) as required by Chapter 4, Article 7, of the Code of the County of Fairfax, Virginia. In order for the Department of Tax Administration to determine your BPOL requirement prior to contract award, it is necessary for you to provide the following information:

- If you currently have a Fairfax County business license, please submit a copy with your proposal.
- Do you have an office in: Virginia Yes No
 Fairfax County Yes No
- Date business began/will begin work in Fairfax County

A detailed description of the business activity that will take place in Fairfax County. If business is located outside of Fairfax County, give the percentage of work actually to be done in the County

Signature

Date

Complete and return this form or a copy of your current Fairfax County Business License with your proposal.

BUSINESS CLASSIFICATION

DEFINITIONS

Small Business – means a business, independently owned or operated by one or more individuals who are U.S. citizens or legal resident aliens, and together with affiliates, has 250 or fewer employees, or average annual gross receipts of \$10 million or less averaged over the previous three years. One or more of the individual owners shall control both the management and daily business operations of the small business.

Minority-Owned Business - means a business concern that is at least 51% owned by one or more minority individuals who are U.S. citizens or legal resident aliens, or in the case of a corporation, partnership, or limited liability company or other entity, at least 51% of the equity ownership interest in the corporation, partnership, or limited liability company or other entity is owned by one or more minority individuals who are U.S. citizens or legal resident aliens, and both the management and daily business operations are controlled by one or more minority individuals.

Woman-Owned Business – means a business that is at least 51% owned by one or more women who are U.S. citizens or legal resident aliens, or in the case of a corporation, partnership, or limited liability company or other entity, at least 51% of the equity ownership interest is owned by one or more women who are U.S. citizens or legal resident aliens, and both the management and daily business operations are controlled by one or more women.

YOU MUST CLASSIFY YOUR BUSINESS/ORGANIZATION BY MARKING THE APPROPRIATE BOXES ON THE COVER SHEET (DPSM32). This designation is required of all business/organizations including publicly traded corporations, non-profits, sheltered work shops, government organizations, partnerships, sole proprietorships, etc.

MASTER INTERGOVERNMENTAL COOPERATIVE PURCHASING AGREEMENT

This agreement is made between certain government agencies that execute a Lead Public Agency Certificate ("Lead Public Agencies") to be appended and made a part hereof and other government agencies ("Participating Public Agencies") that agree to the terms and conditions hereof through the U.S. Communities registration and made a part hereof.

RECITALS

WHEREAS, after a competitive solicitation and selection process by Lead Public Agencies, a number of Suppliers have entered into Master Agreements to provide a variety of goods, products and services based on national and international volumes (herein "Products and Services");

WHEREAS, Master Agreements are made available by Lead Public Agencies through U.S. Communities and provide that Participating Public Agencies may purchase Products and Services on the same terms, conditions and pricing as the Lead Public Agency, subject to any applicable local purchasing ordinances and the laws of the State of purchase;

WHEREAS, the parties desire to comply with the requirements and formalities of the Intergovernmental Cooperation Act as may be applicable to the laws of the State of purchase;

WHEREAS, the parties hereto desire to conserve resources and reduce procurement cost;

WHEREAS, the parties hereto desire to improve the efficiency, effectiveness and economy of the procurement of necessary Products and Services;

NOW, THEREFORE, in consideration of the mutual promises contained in this agreement, and of the mutual benefits to result, the parties agree as follows:

1. That each party will facilitate the cooperative procurement of Products and Services.
2. That the procurement of Products and Services subject to this agreement shall be conducted in accordance with and subject to the relevant statutes, ordinances, rules and regulations that govern each party's procurement practices.
3. That the cooperative use of solicitations obtained by a party to this agreement shall be in accordance with the terms and conditions of the solicitation, except as modification of those terms and conditions is otherwise allowed or required by applicable law.
4. That the Lead Public Agencies will make available, upon reasonable request and subject to convenience, information which may assist in improving the effectiveness, efficiency and economy of Participating Public Agencies procurement of Products and Services
5. That a procuring party will make timely payments to the Supplier for Products and Services received in accordance with the terms and conditions of the procurement. Payment, inspections and acceptance of Products and Services ordered by the procuring party shall be the exclusive obligation of such procuring party. Disputes between procuring party and Supplier are to be resolved in accord with the law and venue rules of the State of purchase.
6. The procuring party shall not use this agreement as a method for obtaining additional concessions or reduced prices for similar products or services.

MASTER INTERGOVERNMENTAL COOPERATIVE PURCHASING AGREEMENT

7. The procuring party shall be responsible for the ordering of Products and Services under this agreement. A non-procuring party shall not be liable in any fashion for any violation by a procuring party, and the procuring party shall hold non-procuring party harmless from any liability that may arise from action or inaction of the procuring party.
8. The exercise of any rights or remedies by the procuring party shall be the exclusive obligation of such procuring party.
9. This agreement shall remain in effect until termination by a party giving 30 days written notice to U.S. Communities at 2033 N. Main Street, Suite 700, Walnut Creek, CA 94596.
10. This agreement shall take effect after execution of the Lead Public Agency Certificate or Participating Public Agency Registration, as applicable.

ADMINISTRATION AGREEMENT

This ADMINISTRATION AGREEMENT ("Agreement") is made as of _____, by and between U.S. COMMUNITIES GOVERNMENT PURCHASING ALLIANCE ("U.S. Communities") and _____ ("Supplier").

RECITALS

WHEREAS, _____ ("Lead Public Agency") has entered into a certain Master Agreement dated as of _____, referenced as Agreement No. _____, by and between Lead Public Agency and Supplier (as amended from time to time in accordance with the terms thereof, the "Master Agreement") for the purchase of _____ (the "Products and Services");

WHEREAS, the Master Agreement provides that any state, county, city, special district, local government, school district, private K-12 school, technical or vocational school, higher education institution (including community colleges, colleges and universities, both public and private), other government agency or nonprofit organization (each a "Public Agency" and collectively, "Public Agencies") may purchase Products and Services at the prices indicated in the Master Agreement upon prior registration with U.S. Communities, in which case the Public Agency becomes a "Participating Public Agency";

WHEREAS, U.S. Communities has the administrative and legal capacity to administer purchases under the Master Agreement to Participating Public Agencies;

WHEREAS, U.S. Communities serves as the administrative agent for Lead Public Agency and other lead public agencies in connection with other master agreements offered by U.S. Communities;

WHEREAS, Lead Public Agency desires U.S. Communities to proceed with administration of the Master Agreement on the same basis as other master agreements;

WHEREAS, "U.S. Communities Government Purchasing Alliance" is a trade name licensed by U.S. Communities Purchasing & Finance Agency; and

WHEREAS, U.S. Communities and Supplier desire to enter into this Agreement to make available the Master Agreement to Participating Public Agencies.

NOW, THEREFORE, in consideration of the payments to be made hereunder and the mutual covenants contained in this Agreement, U.S. Communities and Supplier hereby agree as follows:

ARTICLE I

GENERAL TERMS AND CONDITIONS

- 1.1 The Master Agreement, attached hereto as Exhibit A and incorporated herein by reference as though fully set forth herein, and the terms and conditions contained therein shall apply to this Agreement except as expressly changed or modified by this Agreement.

ADMINISTRATION AGREEMENT

- 1.2 U.S. Communities shall be afforded all of the rights, privileges and indemnifications afforded to Lead Public Agency under the Master Agreement, and such rights, privileges and indemnifications shall accrue and apply with equal effect to U.S. Communities under this Agreement including, without limitation, Supplier's obligation to provide insurance and certain indemnifications to Lead Public Agency.
- 1.3 Supplier shall perform all duties, responsibilities and obligations required under the Master Agreement in the time and manner specified by the Master Agreement.
- 1.4 U.S. Communities shall perform all of its duties, responsibilities and obligations as administrator of purchases under the Master Agreement as set forth herein, and Supplier acknowledges that U.S. Communities shall act in the capacity of administrator of purchases under the Master Agreement.
- 1.5 With respect to any purchases made by Lead Public Agency or any Participating Public Agency pursuant to the Master Agreement, U.S. Communities (a) shall not be construed as a dealer, re-marketer, representative, partner, or agent of any type of Supplier, Lead Public Agency or such Participating Public Agency, (b) shall not be obligated, liable or responsible (i) for any orders made by Lead Public Agency, any Participating Public Agency or any employee of Lead Public Agency or a Participating Public Agency under the Master Agreement, or (ii) for any payments required to be made with respect to such order, and (c) shall not be obligated, liable or responsible for any failure by a Participating Public Agency to (i) comply with procedures or requirements of applicable law, or (ii) obtain the due authorization and approval necessary to purchase under the Master Agreement. U.S. Communities makes no representations or guaranties with respect to any minimum purchases required to be made by Lead Public Agency, any Participating Public Agency, or any employee of Lead Public Agency or a Participating Public Agency under this Agreement or the Master Agreement.

ARTICLE II

TERM OF AGREEMENT

- 2.1 This Agreement is effective as of _____ and shall terminate upon termination of the Master Agreement or any earlier termination in accordance with the terms of this Agreement, provided, however, that the obligation to pay all amounts owed by Supplier to U.S. Communities through the termination of this Agreement and all indemnifications afforded by Supplier to U.S. Communities shall survive the term of this Agreement.

ARTICLE III

REPRESENTATIONS AND COVENANTS

- 3.1 U.S. Communities views the relationship with Supplier as an opportunity to provide benefits to both Public Agencies and Supplier. The successful foundation of the relationship requires certain representations and covenants from both U.S. Communities and Supplier.

ADMINISTRATION AGREEMENT

3.2 U.S. Communities' Representations and Covenants.

- (a) Marketing. U.S. Communities shall proactively market the Master Agreement to Public Agencies using resources such as a network of major sponsors including the National League of Cities (NLC), National Association of Counties (NACo), United States Conference of Mayors (USCM), Association of School Business Officials (ASBO) and National Institute of Governmental Purchasing (NIGP) (collectively, the "Founding Co-Sponsors") and individual state-level sponsors. In addition, the U.S. Communities staff shall enhance Supplier's marketing efforts through meetings with Public Agencies, participation in key events and tradeshows and by providing online tools to Supplier's sales force.
- (b) Training and Knowledge Management Support. U.S. Communities shall provide support for the education, training and engagement of Supplier's sales force as provided herein. Through its staff (each, a "Program Manager" and collectively, the "Program Managers"), U.S. Communities shall conduct training sessions with Supplier and shall conduct calls jointly with Supplier to Public Agencies. U.S. Communities shall also provide Supplier with access to U.S. Communities' private intranet website which provides presentations, documents and information to assist Supplier's sales force in effectively promoting the Master Agreement.

3.3 Supplier's Representations and Covenants. Supplier hereby represents and covenants as follows in order to ensure that Supplier is providing the highest level of public benefit to Participating Public Agencies (such representations and covenants are sometimes referred to as "Supplier's Commitments" and are comprised of the Corporate Commitment, Pricing Commitment, Economy Commitment and Sales Commitment):

- (a) Corporate Commitment.
 - (i) The pricing, terms and conditions of the Master Agreement shall, at all times, be Supplier's primary contractual offering of Products and Services to Public Agencies. All of Supplier's direct and indirect marketing and sales efforts to Public Agencies shall demonstrate that the Master Agreement is Supplier's primary offering and not just one of Supplier's contract options.
 - (ii) Supplier's sales force (including inside, direct and/or authorized dealers, distributors and representatives) shall always present the Master Agreement when marketing Products or Services to Public Agencies.
 - (iii) Supplier shall advise all Public Agencies that are existing customers of Supplier as to the pricing and other value offered through the Master Agreement.
 - (iv) Upon authorization by a Public Agency, Supplier shall transition such Public Agency to the pricing, terms and conditions of the Master Agreement.
 - (v) Supplier shall ensure that the U.S. Communities program and the Master Agreement are actively supported by Supplier's senior executive management.

ADMINISTRATION AGREEMENT

- (vi) Supplier shall provide a national/senior management level representative with the authority and responsibility to ensure that the Supplier's Commitments are maintained at all times. Supplier shall also designate a lead referral contact person who shall be responsible for receiving communications from U.S. Communities concerning new Participating Public Agency registrations and for ensuring timely follow-up by Supplier's staff to requests for contact from Participating Public Agencies. Supplier shall also provide the personnel necessary to implement and support a supplier-based internet web page dedicated to Supplier's U.S. Communities program and linked to U.S. Communities' website and shall implement and support such web page.
 - (vii) Supplier shall demonstrate in its procurement solicitation response and throughout the term of the Master Agreement that national/senior management fully supports the U.S. Communities program and its commitments and requirements. National/Senior management is defined as the executive(s) with companywide authority.
 - (viii) Where Supplier has an existing contract for Products and Services with a state, Supplier shall notify the state of the Master Agreement and transition the state to the pricing, terms and conditions of the Master Agreement upon the state's request. Regardless of whether the state decides to transition to the Master Agreement, Supplier shall primarily offer the Master Agreement to all Public Agencies located within the state.
- (b) **Pricing Commitment.**
- (i) Supplier represents to U.S. Communities that the pricing offered under the Master Agreement is the lowest overall available pricing (net to purchaser) on Products and Services that it offers to Public Agencies. Supplier's pricing shall be evaluated on either an overall project basis or the Public Agency's actual usage for more frequently purchased Products and Services.
 - (ii) **Contracts Offering Lower Prices.** If a pre-existing contract and/or a Public Agency's unique buying pattern provide one or more Public Agencies a lower price than that offered under the Master Agreement, Supplier shall match that lower pricing under the Master Agreement and inform the eligible Public Agencies that the lower pricing is available under the Master Agreement. If an eligible Public Agency requests to be transitioned to the Master Agreement, Supplier shall do so and report the Public Agency's purchases made under the Master Agreement going forward. The price match only applies to the eligible Public Agencies. Below are three examples of Supplier's obligation to match the pricing under Supplier's contracts offering lower prices.
 - (A) Supplier holds a state contract with lower pricing that is available to all Public Agencies within the state. Supplier would be required to match the lower state pricing under the Master Agreement and make it available to all Public Agencies within the state.

ADMINISTRATION AGREEMENT

- (B) Supplier holds a regional cooperative contract with lower pricing that is available only to the ten cooperative members. Supplier would be required to match the lower cooperative pricing under the Master Agreement and make it available to the ten cooperative members.
- (C) Supplier holds a contract with an individual Public Agency. The Public Agency contract does not contain any cooperative language and therefore other Public Agencies are not eligible to utilize the contract. Supplier would be required to match the lower pricing under the Master Agreement and make it available only to the individual Public Agency.
- (iii) Deviating Buying Patterns. Occasionally U.S. Communities and Supplier may interact with a Public Agency that has a buying pattern or terms and conditions that considerably deviate from the normal Public Agency buying pattern and terms and conditions, and causes Supplier's pricing under the Master Agreement to be higher than an alternative contract held by Supplier. This could be created by a unique end-user preference or requirements. In the event that this situation occurs, Supplier may address the issue by lowering the price under the Master Agreement on the item(s) causing the large deviation for that Public Agency. Supplier would not be required to lower the price for other Public Agencies.
- (iv) Supplier's Options in Responding to a Third Party Procurement Solicitation. While it is the objective of U.S. Communities to encourage Public Agencies to piggyback on to the Master Agreement rather than issue their own procurement solicitations, U.S. Communities recognizes that for various reasons some Public Agencies will issue their own solicitations. The following options are available to Supplier when responding to a Public Agency solicitation:
 - (A) Supplier may opt not to respond to the procurement solicitation. Supplier may make the Master Agreement available to the Public Agency as a comparison to its solicitation responses.
 - (B) Supplier may respond with the pricing, terms and conditions of the Master Agreement. If Supplier is awarded the contract, the sales would be reported as sales under the Master Agreement.
 - (C) If competitive conditions require pricing lower than the standard Master Agreement pricing, Supplier may submit lower pricing through the Master Agreement. If Supplier is awarded the contract, the sales would be reported as sales under the Master Agreement. Supplier would not be required to extend the lower price to other Public Agencies.
 - (D) Supplier may respond to the procurement solicitation with pricing that is higher (net to buyer) than the pricing offered under the Master Agreement. If awarded a contract, Supplier shall still be bound by all obligations set forth in this Section 3.3, including, without limitation, the requirement to continue to advise the awarding Public Agency of the pricing, terms and conditions of the Master Agreement.

ADMINISTRATION AGREEMENT

- (E) Supplier may respond to the procurement solicitation with pricing that is higher (net to buyer) than the pricing offered under the Master Agreement and if an alternative response is permitted, Supplier may offer the pricing under the Master Agreement as an alternative for consideration.
- (c) Economy Commitment. Supplier shall demonstrate the benefits, including the pricing advantage, of the Master Agreement over alternative options, including competitive solicitation pricing and shall proactively offer the terms and pricing under the Master Agreement to Public Agencies as a more effective alternative to the cost and time associated with such alternate bids and solicitations.
- (d) Sales Commitment. Supplier shall market the Master Agreement through Supplier's sales force or dealer network that is properly trained, engaged and committed to offering the Master Agreement as Supplier's primary offering to Public Agencies. Supplier's sales force compensation and incentives shall be greater than or equal to the compensation and incentives earned under other contracts to Public Agencies.
- (i) Supplier Sales. Supplier shall be responsible for proactive direct sales of Supplier's Products and Services to Public Agencies and the timely follow-up to sales leads identified by U.S. Communities. Use of product catalogs, targeted advertising, direct mail and other sales initiatives are encouraged. All of Supplier's sales materials targeted towards Public Agencies shall include the U.S. Communities logo. U.S. Communities hereby grants to Supplier, during the term of this Agreement, a non-exclusive, revocable, non-transferable, license to use the U.S. Communities name, trademark, and logo solely to perform its obligations under this Agreement, and for no other purpose. Any goodwill, rights, or benefits derived from Supplier's use of the U.S. Communities name, trademark, or logo shall inure to the benefit of U.S. Communities. U.S. Communities shall provide Supplier with its logo and the standards to be employed in the use of the logo. During the term of the Agreement, Supplier grants to U.S. Communities an express license to reproduce and use Supplier's name and logo in connection with the advertising, marketing and promotion of the Master Agreement to Public Agencies. Supplier shall assist U.S. Communities by providing camera-ready logos and by participating in related trade shows and conferences. At a minimum, Supplier's sales initiatives shall communicate that (i) the Master Agreement was competitively solicited by the Lead Public Agency, (ii) the Master Agreement provides the best government pricing, (iii) there is no cost to Participating Public Agencies, and (iv) the Master Agreement is a non-exclusive contract.
- (ii) Branding and Logo Compliance. Supplier shall be responsible for complying with the U.S. Communities branding and logo standards and guidelines. Prior to use by Supplier, all U.S. Communities related marketing material must be submitted to U.S. Communities for review and approval.

ADMINISTRATION AGREEMENT

- (iii) Sales Force Training. Supplier shall train its national sales force on the Master Agreement and U.S. Communities program. U.S. Communities shall be available to train regional or district managers and generally assist with the education of sales personnel.
- (iv) Participating Public Agency Access. Supplier shall establish the following communication links to facilitate customer access and communication:
 - (A) A dedicated U.S. Communities internet web-based homepage containing:
 - (1) U.S. Communities standard logo with Founding Co-Sponsors logos;
 - (2) Copy of original procurement solicitation;
 - (3) Copy of Master Agreement including any amendments;
 - (4) Summary of Products and Services pricing;
 - (5) Electronic link to U.S. Communities' online registration page; and
 - (6) Other promotional material as requested by U.S. Communities.
 - (B) A dedicated toll-free national hotline for inquiries regarding U.S. Communities.
 - (C) A dedicated email address for general inquiries in the following format: uscommunities@(name of supplier).com.
- (v) Electronic Registration. Supplier shall be responsible for ensuring that each Public Agency has completed U.S. Communities' online registration process prior to processing the Public Agency's first sales order.
- (vi) Supplier's Performance Review. Upon request by U.S. Communities, Supplier shall participate in a performance review meeting with U.S. Communities to evaluate Supplier's performance of the covenants set forth in this Agreement.
- (vii) Supplier Content. Supplier may, from time to time, provide certain graphics, media, and other content to U.S. Communities (collectively "Supplier Content") for use on U.S. Communities websites and for general marketing and publicity purposes. Supplier hereby grants to U.S. Communities and its affiliates a non-exclusive, worldwide, perpetual, free, transferrable, license to reproduce, modify, distribute, publically perform, publically display, and use Supplier Content in connection with U.S. Communities websites and for general marketing and publicity purposes, with the right to sublicense each and every such right. Supplier warrants that: (a) Supplier is the owner of or otherwise has the unrestricted right to grant the rights in and to Supplier Content as contemplated hereunder; and (b) the use of Supplier Content and any other materials or services provided to U.S. Communities as contemplated hereunder will not violate, infringe, or misappropriate the intellectual property rights or other rights of any third party.

ADMINISTRATION AGREEMENT

- 3.4 Breach of Supplier's Representations and Covenants. The representations and covenants set forth in this Agreement are the foundation of the relationship between U.S. Communities and Supplier. If Supplier is found to be in violation of, or non-compliance with, one or more of the representations and covenants set forth in this Agreement, Supplier shall have ninety (90) days from the notice of default to cure such violation or non-compliance and, if Supplier fails to cure such violation or non-compliance within such notice period, it shall be deemed a cause for immediate termination of the Master Agreement at Lead Public Agency's sole discretion or this Agreement at U.S. Communities' sole discretion.
- 3.5 Indemnity. Supplier hereby agrees to indemnify and defend U.S. Communities, and its parent companies, subsidiaries, affiliates, shareholders, member, manager, officers, directors, employees, agents, and representatives from and against any and all claims, costs, proceedings, demands, losses, damages, and expenses (including, without limitation, reasonable attorney's fees and legal costs) of any kind or nature, arising from or relating to, any actual or alleged breach of any of Supplier's representations, warranties, or covenants in this Agreement.

ARTICLE IV

PRICING AUDITS

- 4.1 Supplier shall, at Supplier's sole expense, maintain an accounting of all purchases made by Lead Public Agency and Participating Public Agencies under the Master Agreement. U.S. Communities and Lead Public Agency each reserve the right to audit the accounting for a period of three (3) years from the time such purchases are made. This audit right shall survive termination of this Agreement for a period of one (1) year from the effective date of termination. U.S. Communities shall have the authority to conduct random audits of Supplier's pricing that is offered to Participating Public Agencies at U.S. Communities' sole cost and expense. Notwithstanding the foregoing, in the event that U.S. Communities is made aware of any pricing being offered to Participating Public Agencies that is materially inconsistent with the pricing under the Master Agreement, U.S. Communities shall have the ability to conduct an extensive audit of Supplier's pricing at Supplier's sole cost and expense. U.S. Communities may conduct the audit internally or may engage a third-party auditing firm. In the event of an audit, the requested materials shall be provided in the format and at the location designated by Lead Public Agency or U.S. Communities.

ADMINISTRATION AGREEMENT

ARTICLE V

FEES & REPORTING

- 5.1 Administrative Fees. Supplier shall pay to U.S. Communities a monthly administrative fee based upon the total sales price of all purchases shipped and billed pursuant to the Master Agreement, excluding taxes, in the amount of two percent (2%) of aggregate purchases made during each calendar month (individually and collectively, "Administrative Fees"). Supplier's annual sales shall be measured on a calendar year basis. All Administrative Fees shall be payable in U.S. Dollars and shall be made by wire to U.S. Communities, or its designee or trustee as may be directed in writing by U.S. Communities. Administrative Fees shall be due and payable within thirty (30) days of the end of each calendar month for purchases shipped and billed during such calendar month. U.S. Communities agrees to pay to Lead Public Agency five percent (5%) of all Administrative Fees received from Supplier to help offset Lead Public Agency's costs incurred in connection with managing the Master Agreement nationally.
- 5.2 Sales Reports. Within thirty (30) days of the end of each calendar month, Supplier shall deliver to U.S. Communities an electronic accounting report, in the format prescribed by Exhibit B, attached hereto, summarizing all purchases made under the Master Agreement during such calendar month ("Sales Report"). All purchases indicated in the Sales Report shall be denominated in U.S. Dollars. All purchases shipped and billed pursuant to the Master Agreement for the applicable calendar month shall be included in the Sales Report. U.S. Communities reserves the right upon reasonable advance notice to Supplier to change the prescribed report format to accommodate the distribution of the Administrative Fees to its program sponsors and state associations.
- (a) Monthly Sales Reports shall include all sales reporting under the Master Agreement. Supplier must make reasonable attempts at filling in all required information and contact U.S. Communities with a plan to correct any deficiencies of data field population.
 - (b) Submitted reports shall be verified by U.S. Communities against its registration database. Any data that is inconsistent with the registration database shall be changed prior to processing.
- 5.3 Exception Reporting/Sales Reports Audits. U.S. Communities or its designee may, at its sole discretion, compare Supplier's Sales Reports with Participating Public Agency records or other sales analysis performed by Participating Public Agencies, sponsors, advisory board members or U.S. Communities staff. If there is a material discrepancy between the Sales Report and such records or sales analysis as determined by U.S. Communities, U.S. Communities shall notify Supplier in writing and Supplier shall have thirty (30) days from the date of such notice to resolve the discrepancy to U.S. Communities' reasonable satisfaction. Upon resolution of the discrepancy, Supplier shall remit payment to U.S. Communities' trustee within fifteen (15) calendar days. Any questions regarding an exception report should be directed to U.S. Communities in writing to reporting@uscommunities.org. If Supplier does not resolve the discrepancy to U.S. Communities' reasonable satisfaction within thirty (30) days, U.S. Communities shall have the right to engage outside services to conduct an independent audit of Supplier's reports and Supplier shall be obligated to reimburse U.S. Communities for any and all costs and expenses incurred in connection with such audit.

ADMINISTRATION AGREEMENT

- 5.4 Online Reporting. Within sixty (60) days of the end of each calendar quarter, U.S. Communities shall provide online reporting to Supplier containing Supplier's sales reporting for such calendar quarter. Supplier shall have access to the following reports through the U.S. Communities intranet website, enabling Supplier to better manage the Master Agreement:
- (i) Agency Sales by Population/Enrollment Report
 - (ii) Hot Prospect Sales Report
 - (iii) New Lead Sales Report
 - (iv) State Comparison Sales Report
 - (v) Advisory Board Usage Report
 - (vi) Various Agency Type Comparison Reports
 - (vii) Sales Report Builder
- 5.5 Supplier's Failure to Provide Reports or Pay Administrative Fees. Failure to provide a Sales Report or pay Administrative Fees within the time and in the manner specified herein shall be regarded as a material breach under this Agreement and if not cured within thirty (30) days of written notice to Supplier, shall be deemed a cause for termination of the Master Agreement at Lead Public Agency's sole discretion or this Agreement at U.S. Communities' sole discretion. All Administrative Fees not paid within thirty (30) days of the end of the previous calendar month shall bear interest at the rate of one and one-half percent (1.5%) per month until paid in full.

ARTICLE VI

MISCELLANEOUS

- 6.1 Entire Agreement. This Agreement supersedes any and all other agreements, either oral or in writing, between the parties hereto with respect to the subject matter hereof, and no other agreement, statement, or promise relating to the subject matter of this Agreement which is not contained herein shall be valid or binding.
- 6.2 Attorney's Fees. If any action at law or in equity is brought to enforce or interpret the provisions of this Agreement, the prevailing party shall be entitled to reasonable attorney's fees and costs in addition to any other relief to which such party may be entitled.
- 6.3 Assignment.
- (a) Supplier. Neither this Agreement nor any rights or obligations hereunder shall be assignable by Supplier without prior written consent of U.S. Communities, and any assignment without such consent shall be void.
 - (b) U.S. Communities. This Agreement and any rights or obligations hereunder may be assigned by U.S. Communities in U.S. Communities' sole discretion, to an existing or newly established legal entity that has the authority and capacity to perform U.S. Communities' obligations hereunder.

ADMINISTRATION AGREEMENT

- 6.4 Notices. All reports, notices or other communications given hereunder shall be delivered by first-class mail, postage prepaid, or overnight delivery requiring signature on receipt to the addresses as set forth below. U.S. Communities may, by written notice delivered to Supplier, designate any different address to which subsequent reports, notices or other communications shall be sent.

U.S. Communities: U.S. Communities
 2033 N. Main Street, Suite 700
 Walnut Creek, California 94596
 Attn: Program Manager Administration

Supplier: _____

 Attn: U.S. Communities Program Manager

- 6.5 Severability. If any provision of this Agreement shall be deemed to be, or shall in fact be, illegal, inoperative or unenforceable, the same shall not affect any other provision or provisions herein contained or render the same invalid, inoperative or unenforceable to any extent whatever.
- 6.6 Waiver. Any failure of a party to enforce, for any period of time, any of the provisions under this Agreement shall not be construed as a waiver of such provisions or of the right of said party thereafter to enforce each and every provision under this Agreement.
- 6.7 Counterparts. This Agreement may be executed in several counterparts, each of which shall be an original and all of which shall constitute but one and the same instrument.
- 6.8 Modifications. This Agreement may not be effectively amended, changed, modified, altered or terminated without the prior written consent of the parties hereto.
- 6.9 Governing Law; Arbitration. This Agreement will be governed by and interpreted in accordance with the laws of the State of California without regard to any conflict of laws principles. Any dispute, claim, or controversy arising out of or relating to this Agreement or the breach, termination, enforcement, interpretation or validity thereof, including the determination of the scope or applicability of this dispute resolution clause, shall be determined by arbitration in Walnut Creek, California, before one (1) arbitrator. The arbitration shall be administered by JAMS pursuant to its Comprehensive Arbitration Rules and Procedures. Judgment on the award may be entered in any court having jurisdiction. This clause shall not preclude parties from seeking provisional remedies in aid of arbitration from a court of appropriate jurisdiction. The prevailing party will be entitled to recover its reasonable attorneys' fees and arbitration costs from the other party. The arbitration award shall be final and binding. Each party commits that prior to commencement of arbitration proceedings, the parties shall submit the dispute to JAMS for mediation. The parties will cooperate with JAMS and with one another in selecting a mediator from JAMS panel of neutrals, and in promptly scheduling the mediation proceedings. The parties covenant that they will participate in the mediation in good faith, and that they will share equally in its costs. The mediation will be conducted by each party designating a duly authorized officer or other representative to represent the party with the authority to bind the party, and that the parties agree to exchange informally such information as is reasonably necessary and relevant to the issues being

ADMINISTRATION AGREEMENT

mediated. All offers, promises, conduct, and statements, whether oral or written, made in the course of the mediation by any of the parties, their agents, employees, experts, and attorneys, and by the mediator or any JAMS employees, are confidential, privileged, and inadmissible for any purpose, including impeachment, in any arbitration or other proceeding involving the parties, provided that evidence that is otherwise admissible or discoverable shall not be rendered inadmissible or non-discoverable as a result of its use in the mediation. If the dispute is not resolved within thirty (30) days from the date of the submission of the dispute to mediation (or such later date as the parties may mutually agree in writing), the administration of the arbitration shall proceed. The mediation may continue, if the parties so agree, after the appointment of the arbitrator. Unless otherwise agreed by the parties, the mediator shall be disqualified from serving as arbitrator in the case. The pendency of a mediation shall not preclude a party from seeking provisional remedies in aid of the arbitration from a court of appropriate jurisdiction, and the parties agree not to defend against any application for provisional relief on the ground that a mediation is pending.

6.10 Successors and Assigns. This Agreement shall inure to the benefit of and shall be binding upon U.S. Communities, Supplier and any successor and assign thereto; subject, however, to the limitations contained herein.

IN WITNESS WHEREOF, U.S. Communities has caused this Agreement to be executed in its name and Supplier has caused this Agreement to be executed in its name, all as of the date first written above.

U.S. Communities:

U.S. COMMUNITIES GOVERNMENT PURCHASING ALLIANCE

By _____

Name: _____

Title: _____

Supplier:

By _____

Name: _____

Title: _____

ADMINISTRATION AGREEMENT

EXHIBIT A

MASTER AGREEMENT

(Fairfax County Master Agreement to be attached at time of award.)

ADMINISTRATION AGREEMENT

EXHIBIT B

SALES REPORT FORMAT

Appendix B - US (Data Format)

Sales Report Template													
TIN	Supplier ID	Account No.	Agency Name	Dept Name	Address	City	State	Zip	Agency Type	Year	Qtr	Month	Amount
05000735	180	51110997	CITY OF LAWSAT EMPL SVCS	Purchasing	555 RAMIREZ ST STE 312	LOS ANGELES	CA	90012	20	2012	2	5	1325.50
05000222	180	54900205	LOS ANGELES COUNTY	Facilities	300 S FIGUEROA ST STE 700	LOS ANGELES	CA	90011	20	2012	2	5	1603.64
05000735	180	50400461	CITY OF LAWNBURY AFFAIR	Purchasing	555 RAMIREZ ST STE 312	LOS ANGELES	CA	90012	20	2012	2	5	1623.05
05000735	180	50376835	CITY OF LAWNBURY DEV	Purchasing	555 RAMIREZ ST STE 312	LOS ANGELES	CA	90012	20	2012	2	5	4054.79
09002030	100	22040001053	GRITCHON TOWNSHIP OF PUBLIC WORKS	Water	123 A St	GRITCHON	CT	06340	20	2012	2	5	518.00
09002054	100	22040001051	GRITCHON CITY OF	Administration	123 A St	GRITCHON	CT	06340	20	2012	2	5	212.60

SALES REPORT DATA FORMAT					
Column Name	Required	Data Type	Length	Example	Comment
TIN	Optional	Text	9	05000735	No Dash, Do not include leading zero.
Supplier ID	Yes	Number	3	111	See Supplier ID Table Below
Account No.	Optional	Text	25 max		Depends on supplier account no.
Agency Name	Yes	Text	255 max		Los Angeles County
Dept Name	Optional	Text	255 max		Purchasing Dept
Address	Yes	Text	255 max		
City	Yes	Text	255 max	Los Angeles	Must be a valid City name
State	Yes	Text	2	CA	
Zip	Yes	Text	5	90071	No Dash, Do not omit leading zero, Valid zip code
Agency Type	Yes	Number	2	30	See Agency Type Table Below
Year	Yes	Number	4	2010	
Qtr	Yes	Number	1	4	
Month	Yes	Number	2	12	
Amount	Yes	Number	variable	4000.79	Two digit decimal point, no \$ sign or commas

Agency Type Table	
Agency Type ID	Agency Type Description
10	K-12
11	Community College
12	College and University
20	City
21	City Special District
22	Consolidated City/County
30	County
31	County Special District
40	Federal
41	Crown Corporation
50	Housing Authority
80	State Agency
81	Independent Special District
92	Non-Profit
94	Other

STATE NOTICE ADDENDUM

Pursuant to certain state notice provisions the following public agencies and political subdivisions of the referenced public agencies are eligible to access the contract award made pursuant to this solicitation. Public agencies and political subdivisions are hereby given notice of the foregoing request for proposal for purposes of complying with the procedural requirements of said statutes:

Nationwide:

http://www.usa.gov/Agencies/Local_Government/Cities.shtml

Other states:

State of Oregon, State of Hawaii, State of Louisiana, State of Washington

State: HI

Account Type: K-12

ST JOHN THE BAPTIST

PACIFIC BUDDHIST ACADEMY

HAWAII TECHNOLOGY ACADEMY

CONGREGATION OF CHRISTIAN BROTHERS OF HAWAII, INC.

MARYKNOLL SCHOOL

ISLAND SCHOOL

KE KULA O S. M. KAMAKAU

KAMEHAMEHA SCHOOLS

HANAHAU'OLI SCHOOL

EMMANUAL LUTHERAN SCHOOL

Account Type: County

BOARD OF WATER SUPPLY

MAUI COUNTY COUNCIL

Account Type: Non-Profit

Naalehu Assembly of God

University of the Nations

outrigger canoe club

St. Theresa School

Hawaii Peace and Justice

Kauai Youth Basketball Association

NA HALE O MAUI

LEEWARD HABITAT FOR HUMANITY

WAIANAE COMMUNITY OUTREACH

NA LEI ALOHA FOUNDATION

HAWAII FAMILY LAW CLINIC DBA ALA KUOLA

BUILDING INDUSTRY ASSOCIATION OF HAWAII

UNIVERSITY OF HAWAII FEDERAL CREDIT UNION

LANAKILA REHABILITATION CENTER INC.

POLYNESIAN CULTURAL CENTER

CTR FOR CULTURAL AND TECH INTERCHNG BETW EAST AND WEST

BISHOP MUSEUM

STATE NOTICE ADDENDUM

ALCOHOLIC REHABILITATION SVS OF HI INC DBA HINA MAUKA

ASSOCIATION OF OWNERS OF KUKUI PLAZA

MAUI ECONOMIC DEVELOPMENT BOARD

NETWORK ENTERPRISES, INC.

HONOLULU HABITAT FOR HUMANITY

ALOHACARE

ORI ANUENUE HALE, INC.

IUPAT, DISTRICT COUNCIL 50

GOODWILL INDUSTRIES OF HAWAII, INC.

HAROLD K.L. CASTLE FOUNDATION

MAUI ECONOMIC OPPORTUNITY, INC.

EAH, INC.

PARTNERS IN DEVELOPMENT FOUNDATION

HABITAT FOR HUMANITY MAUI

W. M. KECK OBSERVATORY

HAWAII EMPLOYERS COUNCIL

HAWAII STATE FCU

MAUI COUNTY FCU

PUNAHOU SCHOOL

YMCA OF HONOLULU

EASTER SEALS HAWAII

AMERICAN LUNG ASSOCIATION

St. Francis Medical Center

MAUI FAMILY YMCA

WAILUKU FEDERAL CREDIT UNION

ST. THERESA CHURCH

HALE MAHAOLU

Hawaii Island Humane Society

First United Methodist Church

AOAO Royal Capitol Plaza

Hawaii Carpenters Market Recovery Program Fund

Saint Louis School

Kroc Center Hawaii

Account Type: College and University

ARGOSY UNIVERSITY

HAWAII PACIFIC UNIVERSITY

UNIVERSITY OF HAWAII AT MANOA

RESEARCH CORPORATION OF THE UNIVERSITY OF HAWAII

BRIGHAM YOUNG UNIVERSITY - HAWAII

University Clinical Research and Association

CHAMINADE UNIVERSITY OF HONOLULU

Account Type: Other

Hawaii Information Consortium

Leeward Community Church

Account Type: Unknown

TURTLE BAY RESORT GOLF CLUB

STATE NOTICE ADDENDUM

Account Type: Community College
COLLEGE OF THE MARSHALL ISLANDS

Account Type: State Agency
DOT Airports Division Hilo International Airport
STATE OF HAWAII, DEPT. OF EDUCATION
ADMIN. SERVICES OFFICE
SOH- JUDICIARY CONTRACTS AND PURCH
STATE DEPARTMENT OF DEFENSE
HAWAII CHILD SUPPORT ENFORCEMENT AGENCY
HAWAII HEALTH SYSTEMS CORPORATION
HAWAII AGRICULTURE RESEARCH CENTER
STATE OF HAWAII

Account Type: Consolidated City/County
CITY AND COUNTY OF HONOLULU

State: LA

Account Type: K-12
Orleans Parish School Board
Brother Martin High School
Morris Jeff Community School
Alexandria Country Day School
DARBONNE WOODS CHARTER SCHOOL, INC.
MENTORSHIP ACADEMY
CADDO PARISH SCHOOLS
JESUS THE GOOD SHEPHERD SCHOOL
HOSANNA FIRST ASSEMBLY OF GOD
DIOCESE OF LAFAYETTE
NORTHEAST BAPTIST SCHOOL
CHILDREN'S CHARTER MIDDLE SCHOOL
VISITATION OF OUR LADY CATHOLIC SCHOOL
DELHI CHARTER SCHOOL
ACADIA PARISH SCHOOL BOARD
ST. AMANT HIGH SCHOOL
AVOYELLES PARISH SCHOOL BOARD
BEAUREGARD PARISH SCHOOL BOARD
CALCASIEU PARISH SCHOOL SYSTEM
CATAHOULA PARISH SCHOOL BOARD
VIDALIA JUNIOR HIGH SCHOOL
DeSoto Parish School Board
EAST CARROLL PARISH SCHOOL BOARD
IBERVILLE PARISH SCHOOL BOARD
JACKSON PARISH SCHOOL BOARD
JEFFERSON DAVIS PARISH SCHOOL BOARD
JEFFERSON PARISH SCHOOL BOARD
LINCOLN PARISH SCHOOL BOARD
Recovery School District
MADISON PARISH SCHOOL BOARD
MOREHOUSE PARISH SCHOOL BOARD
OUACHITA PARISH SCHOOL BOARD

STATE NOTICE ADDENDUM

RICHLAND PARISH SCHOOL BOARD
ST. BERNARD PARISH PUBLIC SCHOOL DISTRICT
ST LANDRY PARISH SCHOOL BOARD
St.Mary Parish School Board
TANGIPAOHA PARISH SCHOOL SYSTEM
NEWELLTON ELEMENTARY SCHOOL
UNION PARISH SCHOOL BOARD
VERMILION PARISH SCHOOL BOARD
VERNON PARISH SCHOOL BOARD
WEST BATON ROUGE PARISH SCHOOL BOARD
WEST CARROLL PARISH SCHOOL BOARD
WINN PARISH SCHOOL BOARD
MONROE CITY SCHOOLS
ST JOSEPH THE WORKER
Parkview Baptist
ST. MARIA GORETTI CHURCH
ST MARY'S DOMINICAN HS
ST. AUGUSTINE HIGH SCHOOL
ARCHBISHOP RUMMEL HIGH SCHOOL
CATHOLIC OF POINTE COUPEE SCHOOL
Archbishop Shaw High School
E.D. WHITE CATHOLIC HIGH
CENTRAL PRIVATE SCHOOL
CENTRAL SCHOOL CORP.
EPISCOPAL HIGH SCHOOL OF BATON ROUGE
OAK FOREST ACADEMY
RIVERSIDE ACADEMY
HOLY TRINITY LUTHERAN CHURCH AND SCHOOL
OPELOUSAS CATHOLIC SCHOOL
ST. JOHN ELEMENTARY/MIDDLE SCHOOL
LIVINGSTON PARISH PUBLIC SCHOOLS
THE DUNHAM SCHOOL
EXCELSIOR CHRISTIAN SCHOOL
STATE DEPARTMENT OF EDUCATION
GRACE LUTHERAN CHURCH AND EARLY CHILDHOOD CENTER
ST. CLETUS SCHOOL
CLAIBORNE PARISH SCHOOL BOARD
LAFAYETTE PARISH SCHOOL SYSTEM
LORANGER HIGH SCHOOL FOOTBALL
ST. PIUS X SCHOOL
ACADEMY OF THE SACRED HEART
ST. JOAN OF ARC SCHOOL
ST. DOMINIC SCHOOL
WESTMINSTER CHRISTIAN ACADEMY
CATHOLIC HIGH SCHOOL
Parkview Elementary PTO
Cedar Creek School
Faith Lutheran High School

STATE NOTICE ADDENDUM

Advocacy for the Arts & Technology
 LITTLE ANGELS SCHOOL AND DAY CARE
 CADDO PARISH MAGNET HIGH SCHOOL
 BOSSIER PARISH SCHOOL BOARD
 RAPIDES PARISH SCHOOL BOARD
 St. Edward School
 LaSalle Parish School District
 LSMSA
 Bogalusa School Board
 St. Charles Parish Public Schools
 Parkview Baptist School
 Ursuline Academy of New Orleans
 Bossier Parish School Board (BPSB)

Account Type: County

Vermilion Parish Police Jury
 ST.CHARLES SHERIFFS OFFICE
 St Landry Parish Government
 St. James Parish Government
 Calcasieu Parish Sheriff's Office
 JEFFERSON PARISH DISTRICT ATTORNEY
 ASSUMPTION PARISH LIBRARY
 ST. BERNARD PARISH ADULT DRUG COURT
 WINN PARISH DISTRICT ATTORNEY
 GRANT PARISH POLICE JURY
 BIENVILLE PARISH POLICE JURY
 BOSSIER PARISH ASSESSOR
 BOSSIER PARISH CLERK OF CT
 BOSSIER SHERIFFS DEPARTMENT
 CADDO PARISH TAX ASSESSOR
 CALDWELL PARISH CLERK OF COURT
 CLAIBORNE PARISH POLICE JURY
 DESOTO PARISH POLICE JURY
 EAST BATON ROUGE PARISH CLERK OF COURT
 EAST FELICIANA PARISH SHERIFF OFFICE
 JACKSON PARISH POLICE JURY
 LINCOLN PARISH LIBRARY
 MOREHOUSE PARISH POLICE JURY
 CITY OF OPELOUSAS
 OUACHITA PARISH POLICE JURY
 POINTE COUPEE PARISH POLICE JURY
 RAPIDES PARISH POLICE JURY
 ST. CHARLES PARISH
 ST JOHNS THE BAPTIST PARISH
 ST. MARY PARISH GOVERNMENT
 UNION PARISH HOMELAND SECURITY
 WEBSTER PARISH POLICE JURY
 WEST CARROLL PARISH SHERIFFS DEPT.
 WEST FELICIANA COMMUNICATIONS DISTRICT

STATE NOTICE ADDENDUM

WINN PARISH POLICE JURY
 CATAHOULA PARISH POLICE JURY
 JEFFERSON PARISH GOVERNMENT
 TENSAS PARISH POLICE JURY
 ST TAMMANY FIRE DISTRICT 4
 IBERVILLE PARISH COUNCIL
 OUACHITA MULTI-PURPOSE COMMUNITY ACTION PROGRAM, INC
 SOUTH CENTRAL PLANNING AND DEVELOPMENT COMMISSION
 CALDWELL PARISH HOUSING AUTHORITY
 FRANKLIN ECONOMIC DEVELOPMENT FOUNDATION
 RICHLAND PARISH LIBRARY
 ORLEANS PARISH CRIMINAL SHERIFFS OFFICE
 THIRD JUDICIAL DISTRICT COURT
 RAPIDES PARISH LIBRARY
 FI Parish Juvenile Detention Center
 PARISH OF ASCENSION
 Lafourche Parish Government State Of Louisiana
 JUDICIAL EXPENSE FUND
 GRANT PARISH POLICE JURY GAS DEPT.
 LA SALLE PARISH POLICE JURY
 DESOTO PARISH EMS
 DESOTO PARISH TAX ASSESSOR
 CADDO PARISH COMMISSION
 RICHLAND PARISH SHERIFF DEPARTMENT
 CONCORDIA PARISH POLICE JURY
 East Baton Rouge Parish Drug Court Treatment Center
 OUACHITA PARISH POLICE JURY
 St. Tammany Parish Assessor
 Livingston Council On Aging
 St. Landry Parish Tourist Commission
 PLAQUEMINES PARISH GOVERNMENT
 East Baton Rouge Parish Family Court
 Acadia Parish Clerk of Court

Account Type: Non-Profit

St. Landry Parish Community Action Agency
 Zoar Baptist Church
 East Baton Rouge Mortgage Finance Authority
 Rebuilding Together New Orleans
 Touro Infirmary
 Acadiana CARES
 Presbytery of South Louisiana - Project Homecoming
 family service of greater new orleans
 The Magnolia School, Inc
 Church United for Community Development
 Plaquemines Community C.A.R.E. Center
 jerico road episcopal housing initiative
 greater mount calvary baptist church
 LA ASSOCIATION COMMUNITY ACTION PARTNERSHIPS

STATE NOTICE ADDENDUM

BOOST FOUNDATION, INC.
NEW GENERATIONS CHURCH OF MONROE, INC
SUMMER GROVE BAPTIST ACADEMY
NALC BRANCH 136
GRACE COMMUNITY CHURCH
COMITE BAPTIST CHURCH
GULF COAST HOUSING PARTNERSHIP
COMMITTEE FOR PLAQUEMINES RECOVERY
THE FULLER CENTER FOR HOUSING OF NWLA
DESOTO PARISH LIBRARY
SEEKER SPRINGS MINISTRY CENTER
THE CELL COMMUNITY SCHOOL & RESOURCE CENTER
ELDERCARE SUPPORT SERVICES
MARY BIRD CANCER CENTER
LOUISIANA HEALTH CARE QUALITY FORUM
LEWIS CME
ST. BERNARD PROJECT
PRIDE COMMUNITY ASSOCIATION
HARVEST CHURCH
ALLEGIANCE HEALTH MANAGEMENT
UPWARD BOUND MINISTRIES, INC.
IBTS
HANDS ON NETWORK
CROSSROADS CHURCH
ST. PAUL BAPTIST CHURCH
COMMUNITY SUPPORT PROGRAMS, INC.
LAFAYETTE TEEN COURT, INC
THE SHREVEPORT-BOSSIER KOREAN PRESBYTERIAN CHURCH
URBAN IMPACT MINISTRIES
Cornerstone Church of Zachary Inc
GOOD SAMARITANS OF FRANKLIN
LOUISIANA ASSOCIATION OF HEALTH PLANS
LOUIS INFANT CRISIS CENTER
GRACE LIFE FELLOWSHIP
FAMILY WORSHIP CENTER CHURCH INC
UNITY FOR THE HOMELESS, INC.
NEW TABERNACLE BAPTIST CHURCH
CENLA AREA AGENCY ON AGING, INC.
UNITED METHODIST HOPE MINISTRIES
HEALING PLACE CHURCH
RAPIDES PRIMARY HEALTH CARE CENTER
K AND S CHILDHOOD DEVELOPMENT CENTER
MOUNT HERMON BAPTIST CHURCH
PLEASANT VALLEY UNC
LIVINGSTON PARISH PRESIDENT-COUNCIL
LINCOLN GENERAL HOSPITAL
CROSSPOINT BAPTIST CHURCH
MACEDONIA MISSIONS, INC.

STATE NOTICE ADDENDUM

MT. PLEASANT COMMUNITY DEVELOPMENT CORP. INC.
 Jefferson Chamber of Commerce
 FAMILY RESOURCES OF NEW ORLEANS
 LOUISIANA FAMILY FORUM
 PCPFHF
 FAMILY MEDICAL CLINIC OF MER ROUGE
 NEW BEGINNINGS CDC
 FAITH TABERNACLE CHURCH
 THE WAY OF HOLINESS APOSTOLIC CHURCH
 MIRACLE PLACE CHURCH
 THE HARVEST
 POLICE JURY ASSOCIATION OF LOUISIANA
 NSU CHILD AND FAMILY NETWORK
 MOREHOUSE GENERAL HOSPITAL
 BROADMOOR CHRISTIAN CHURCH
 MW PRINCE HALL MASONIC HALL TEMPLE
 LITTLE THEATRE OF MONROE, INC.
 BOSSIER CHAMBER OF COMMERCE
 ST. ANDREW PRESBYTERIAN CHURCH
 WEST JEFFERSON MEDICAL CENTER
 IBERIA MEDICAL CENTER
 BROADMOOR UNITED METHODIST PRESCHOOL
 ST. ANSELM CATHOLIC CHURCH
 ST. FRANCES XAVIER CABRINI CATHOLIC CHURCH
 KIWANIS INTERNATIONAL
 Tulane Hillel
 DISABLED VETERNS OF LA CHAPTER 4
 SHREVEPORT ELECTRICAL HEALTH AND WELFARE FUND
 LAFAYETTE PARISH CONVENTION & VISITORS COMMISSION
 ISTROUMA AREA COUNCIL OF BOY SCOUTS
 UNITED CEREBAL PALSY OF GREATER NEW ORLEANS, INC
 RIDGE AVENUE BAPTIST CHURCH
 Girls Scouts Louisiana East
 CHILDREN'S HOSPITAL
 LOUISIANA SPCA
 FIRST BAPTIST CHURCH RUSTON
 GIRL SCOUTS OF LA - PINES TO GULF
 UNITED WAY OF NORTHEAST LOUISIANA, INC.
 LOUISIANA REALTORS ASSOCIATION
 LOUISIANA HIGH SCHOOL ATHLETIC ASSOCIATION
 ST. GEORGE CHURCH
 JACKSON PARISH HOSPITAL
 ROMAN CATHOLIC CHURCH OF THE DIOCESE OF BATON ROUGE
 ARCHDIOCESE OF NEW ORLEANS
 TOTAL COMMUNITY ACTION, INC.
 AVOYELLES PROGRESS ACTION COMMITTEE, INC
 CENLA COMMUNITY ACTION COMMITTEE, INC.
 PCSS

STATE NOTICE ADDENDUM

ST. MICHAEL SPECIAL SCHOOL
MACON ECONOMIC OPPORTUNITY
LIVINGSTON PARISH CHAMBER OF COMMERCE
FIRST BAPTIST CHURCH COVINGTON
JEWISH FEDERATION OF GREATER BATON ROUGE
COOK BAPTIST CHURCH
ST. MARY CAA, INC.
OUR LADY OF PROMPT SUCCOR CHURCH
NEW CHAPEL HILL BAPTIST CHURCH
The Arc Of Iberia
MCIO HEAD START
FRANKLIN MEDICAL CENTER
HOSPITAL SERVICE DISTRICT NO.1, D/B/A TRI-WARD
EASTER SEALS LOUISIANA
VOLUNTEERS OF AMERICA OF GREATER NEW ORLEANS
ST. ALOYSIUS CATHOLIC SCHOOL
LOUISIANA DISTRICT ATTORNEYS ASSOCIATION
ODYSSEY HOUSE LOUISIANA, INC.
HAVEN NURSING CENTER, INC.
KING OF KINGS EVANGELICAL LUTHERAN CHURCH
ST. JEAN VIANNEY CHURCH
Southern Financial Exchange
new home ministries
HEBRON BAPTIST CHURCH
ST THOMAS AQUINAS CATHOLIC CHURCH
GREATER OUACHITA WATER COMPANY
MT. VERNON BAPTIST CHURCH
LA ASSEMBLY OF THE CHURCH OF GOD
CENTRAL CITY EOC
ST. MARY PARISH TOURIST COMMISSION
PINE BELT MULTI-PURPOSE COMMUNITY ACTION AGENCY
UNIVERSITY CHURCH OF CHRIST
CITY OF FAITH PRISON MINISTRIES, INC.
THE SPIRIT OF FREEDOM MINISTRIES
BONITA ROAD BAPTIST CHURCH
EVANGELINE BAPTIST CHURCH
HOPEWELL BAPTIST CHURCH
PENIEL BAPTIST CHURCH
ASSOCIATED PROFESSIONAL EDUCATORS OF LOUISIANA
PHILADELPHIA BAPTIST CHURCH
HOSANNA LUTHERAN CHURCH
MOUNT CANAAN MISSIONARY BAPTIST CHURCH
NEW DAUGHTERS OF ZION MISSIONARY BAPTIST CHURCH IN
MARION BAPTIST CHURCH
VERNON COMMUNITY ACTION COUNCIL, INC.
FIRST CHURCH OF GOD IN OAK GROVE, INC.
Ouachita Baptist Church
OLIVE BRANCH BAPTIST CHURCH

STATE NOTICE ADDENDUM

FIRST APOSTOLIC CHURCH
SOLOMON TEMPLE BAPTIST CHURCH
WEST BATON ROUGE CHAMBER OF COMMERCE
IFA CHURCH
LA ONE CALL
ST. FRANCIS DINER
SWEETWATER BAPTIST CHURCH
THE CHURCH OF THE LIVING GOD
WORKFORCE INVESTMENT BOARD SDA-83
TRAILBLAZER RESOURCE AND CONSERVATION AREA, INC.
PRESBYTERIAN CHURCH OF RUSTON
ADVOCACY CENTER FOR THE ELDERLY AND DISABLED, INC.
ST.MARY PARISH LIBRARY
THE HOUSE OF FAITH HOPE AND CHARITY
THE SALVATION ARMY
EMMANUEL BAPTIST CHURCH
BOY SCOUTS OF AMERICA
FIRST BAPTIST CHURCH
FIRST UNITED METHODIST CHURCH
ST. JOHN THE BAPTIST CATHOLIC CHURCH
FIRST BAPTIST CHURCH
ST PATRICK CHURCH
GRACE EPISCOPAL CHURCH
TRINITY LUTHERAN CHURCH
FIRST BAPTIST CHURCH
EMMANUEL BAPTIST CHURCH
ANTIOCH BAPTIST CHURCH
ST. JOHN THE BAPTIST CATHOLIC CHURCH
TRINITY BAPTIST CHURCH
Baton Rouge Soccer Association
ST. PAULS UNITED METHODIST CHURCH
PARKVIEW BAPTIST CHURCH
OPEN DOOR BAPTIST CHURCH
Galilee Baptist Academy
Volunteers of America of North Louisiana
GIBSON AREA HOSPITAL
First United Methodist Church
Port City Enterprises
Baton Rouge Children's Advocacy Center
Go Care
Trinity Episcopal Church
Beginners Mind Inc
Wisner Foundation
Berean Church
South Central Laborers
Southern United Neighborhoods
Franklin Medical Center
Livingston Parish Council

STATE NOTICE ADDENDUM

New Orleans Museum Of Art
Our Lady of Victory
Ingleside United Methodist Church
congregation temple sinai
NORTHWEST LOUISIANA LIONS EYE BANK
NEW HORIZONS
UNITED AUTO WORKERS UNION
STEEPLE CHASE BAPTIST CHURCH
METRO/REGIONAL BUSINESS INCUBATOR
BENTON UNITED METHODIST CHURCH
EMMANUEL MISSIONARY BAPTIST CHURCH
ELIZABETH BAPTIST CHURCH
LITTLE UNION BAPTIST CHURCH
BARKSDALE UNITED METHODIST CHURCH
MORING STAR BAPTIST CHURCH
PEACEFUL REST BAPTIST CHURCH
UNITED WAY OF NW LOUISIANA
WORD OF LIFE MINISTRIES
FROM BONDAGE TO FREEDOM
LANE CHAPEL CME
NATIONAL SAFETY COUNCIL
PLEASEAN HILL BAPTIST CHURCH
MT. ZION CME CHURCH
CENTRAL ASSEMBLY OG GOD
MEYERS MEMORIAL CHAPEL
LAKE BETHLEHEM BAPTIST CHURCH
BROADMOOR PRESBYTERIAN CHURCH
ST. MARYS BAPTIST CHURCH
GREATER HOPE BAPTIST CHURCH
STERLINGTON HOLINESS TABERNACLE
YMCA OF SHREVEPORT, LA
SUMMER GROVE BAPTIST CHURCH
STARLIGHT BAPTIST CHURCH
ST. REST BAPTIST CHURCH
LAKESIDE BAPTIST CHURCH
EMMANUEL BAPTIST CHURCH
SHOWERS OF BLESSING MINISTRIES
CALVARY BAPTIST CHURCH
GREATER ELIZABETH BAPTIST CHURCH
SHREVEPORT REGIONAL ARTS COUNCIL
NEW TESTAMENT UNITED PENTECOSTAL CHURCH
CHRISTVIEW CHRISTIAN CHURCH
NEW GREENWOOD BAPTIST CHURCH
BARKSDALE FEDERAL CREDIT UNION
TRINITY WORSHIP CENTER
Lafayette Habitat for Humanity
Nativity of Our Lady Church
Full Gospel Church

STATE NOTICE ADDENDUM

Health Care Centers In Schools
 First United Methodist Church of Slidell
 HOUSE OF RUTH, INC..
 Habitat for Humanity St. Tammany West
 Volunteers of America Greater Baton Rouge, Inc.
 New Orleans BioInnovation Center
 Our Lady of Perpetual Help Catholic Church
 St. Peter Catholic Church
 St. Agnes Catholic Church
 Goodwill Industries
 Capital Area Alliance for Homeless
 New Life Missionary Baptist Church
 Louisiana Hemopheilia Foundation Inc
 ST. ALBAN'S CHAPEL
 lisamaye fighting lupus and raising awareness
 Broadmoor Improvement Association
 Divine Touch Community development Center
 Galvez Football Club Inc

Account Type: College and University

Louisiana Universities Marine Consortium
 CAMERON COLLEGE
 LOUISIANA TECHNICAL COLLEGE
 SOUTHEASTERN LOUISIANA UNIVERSITY
 LOUISIANA STATE UNIVERSITY
 CENTENARY COLLEGE OF LOUISIANA
 DILLARD UNIVERSITY
 LOYOLA UNIVERSITY OF NEW ORLEANS
 THE ADMINISTRATORS OF THE TULANE EDUCATIONAL FUND
 NOTRE DAME SEMINARY
 NEW ORLEANS BAPTIST THEOLOGICAL SEMINARY
 OUR LADY OF HOLY CROSS COLLEGE
 LSUHSC - SHREVEPORT
 Kappa Kappa Gamma
 Louisiana State University
 Louisiana, University Of Lafayette
 SOUTHERN UNIVERSITY
 McNeese State University

Account Type: Other

Vermilion Parish Sheriff Dept.
 st. charles united methodist church
 New Orleans Redevelopment Authority
 Chris Raggio
 NWL TECHNICAL COLLEGE
 ACI ST JOHN LLC
 SOUTHSIDE ECONOMIC DEVELOPMENT
 A AND B NOTARY
 NEW ORLEANS JAZZ ORCHESTRA
 HAVEN REHABILITATION CENTER, INC.

STATE NOTICE ADDENDUM

PONCHATOULA AREA RECREATION DISTRICT NO.1
 UNITECH TRAINING ACADEMY
 VERMILION PARISH WATERWORKS DISTRICT NO.1
 BOSSIER PARISH MAXIMUM SECURITY JAIL
 WEST BATON ROUGE S/O WORK RELEASE
 DEMCO
 LOD AND CAROL COOK CONFERENCE CENTER AND HOTEL
 G B COOLEY SERVICES
 NORTH CADDO MEDICAL CENTER
 Union Community Action, Association
 WEST BATON ROUGE PARISH POLICE JURY
 UNION COUNCIL ON AGING
 REPUBLICAN PARTY OF LA
 CHITIMACHA TRIBE OF LOUISIANA
 CAJUNDOME
 AGAPE LOVE
 Port Shreveport Bossier
 Greater Elizabeth
 CALLAWAY ENTERPRISES
 APOSTOLIC DELIVERANCE U.P.C. INC.
 UNION SPRINGS MBC
 WILLIAMS MEMORIAL CME
 LAKESIDE DAY CARE
 AMERICAN CHILD DAY CARE CENTER
 WILLIS-KNIGHTON FEDERAL CREDIT UNION
 MT. SINAI MBC
 Shell Robert Training & Conference Center
 St. John the Baptist Parish Library
 Louisiana Workforce LLC
 First Baptist Church

Account Type: Unknown

SHREVEPORT OXYGEN
 CALDWELL MEMORIAL HOSPITAL
 Housing Authority City of Natchitoches AMP20
 Larose Lower Elementary
 LA DEPARTMENT OF MILITARY AFFAIRS
 Terrebonne Parish Consolidated Government Warehouse

Account Type: City Special District

FIRE PROTECTION DIST. NO. 5
 RAYNE HOUSING AUTHORITY
 GREATER NEW ORLEANS EXPRESSWAY COMMISSION
 Sewerage and Water Board

Account Type: Independent Special District

UNIVERSITY HOUSE@ACADIANA
 ALLEN PARISH FIRE PROTECTION DISTRICT FIVE
 ST. GEORGE FIRE PROTECTION DISTRICT NO.2
 POVERTY POINT RESERVOIR DISTRICT
 BOARD OF COMMISSIONERS OF THE PORT OF NEW ORLEANS

STATE NOTICE ADDENDUM

LAFAYETTE AIRPORT COMMISSION
CAPITAL AREA LEGAL SERVICES CORP
NEW ORLEANS REGIONAL BUSINESS PARK
ST. TAMMANY PARISH FIRE PROTECTION DISTRICT NO. 3
BOSSIER PARISH COMMUNICATIONS DISTRICT NO. 1

Account Type: City

City of Morgan City/Planning and Zoning

Town of St. Francisville

CITY OF VILLE PLATTE

BUNKIE FIRE DEPT

MONROE CITY

TOWN OF ARCADIA

TOWN OF BENTON

CITY OF BOSSIER

CADDO PARISH CLERK OF COURT

CITY OF COVINGTON

EVANGELINE PARISH SHERIFF DEPT.

TOWN OF FARMERVILLE

TOWN OF HAYNESVILLE

TOWN OF JONESVILLE

CITY OF LAKE CHARLES FIRE DEPT

CITY OF LEESVILLE

CITY OF MINDEN

CITY OF NEW ROADS

TOWN OF OLLA

CITY OF PLAQUEMINE

PONCHATOULA POLICE DEPT.

TOWN OF RAYVILLE

CITY OF RUSTON

ST. BERNARD PARISH GOVERNMENT

ST LANDRY PARISH SHERIFF DEPT

Sewerage and Water Board of New Orleans

CITY OF SHREVEPORT

CITY OF SLIDELL

CITY OF WEST MONROE

CITY OF WINNFIELD

CITY OF WINNSBORO

CITY OF KENNER

CITY OF WESTLAKE

TOWN OF CHURCH POINT

VILLAGE OF PALMETTO

TOWN OF WHITE CASTLE

TOWN OF WATERPROOF

CITY OF BAKER POLICE DEPARTMENT

BREAUX BRIDGE HOUSING AUTHORITY

CAPITAL CITY PRESS

TOWN OF GRAND ISLE

ASCENSION PARISH LIBRARY

STATE NOTICE ADDENDUM

GREATER NEW ORLEANS FOUNDATION
 LOUISIANA PUBLIC EMPLOYEES COUNCIL 17 AFSCME AFL- CIO
 BUILDING CORP
 VILLAGE OF FENTON
 TOWN OF PEARL RIVER
 VILLAGE OF FOREST HILL
 BALL POLICE DEPARTMENT
 TOWN OF ROSEPINE
 TOWN OF LEONVILLE
 DENHAM SPRINGS CITY MARSHAL
 CITY OF PORT ALLEN
 CITY OF MONROE
 CITY OF HAMMOND
 CITY OF ALEXANDRIA
 Pelican State Credit Union
 City of Harahan
 TOWN OF HOMER
 TOWN OF STERLINGTON
 TOWN OF JONESBORO
 St John Sheriff Office
 city of gretna
 City Of Rayne
 City of Westwego Parks & Recreation

Account Type: County Special District

st. landry parish solid waste
 15TH JUDICIAL DISTRICT COURT
 FIRE PROTECTION DISTRICT NO 1 OF TENSAS PARISH
 GRANT PARISH SHERIFF
 IBERIA PARISH GOVERNMENT
 TANGIPAOHA MOSQUITO ABATEMENT DISTRICT
 SULPHUR PARKS AND RECREATION
 BOSSIER LEVEE DISTRICT
 EAST CENTRAL BOSSIER PARISH FIRE DISTRICT #1
 Castine Center
 St. Mary Parish Recreation District #3

Account Type: Community College

THE ART STATION
 COMPASS CAREER COLLEGE
 SOUTH LA COMMUNITY COLLEGE
 DELGADO COMMUNITY COLLEGE
 GRETNA CAREER COLLEGE
 Acadiana Technical College
 sowela tech comm college

Account Type: State Agency

The Housing Authority of the City of Opelousas
 Isu health systems
 Leonard J Chabert Medical Center
 LA State Board Of Medical Examiners

STATE NOTICE ADDENDUM

LA RESEARCH PARK CORPORATION
 CONCEALED HANDGUN PERMIT UNIT
 DEPT OF CULTURE RECREATION AND TOURISM
 DEPARTMENT OF REVENUE/LOUISIANA
 LA. DIVISION OF ADMINISTRATION
 LOUISIANA TECH UNIVERSITY
 DHH-OFFICE OF PUBLIC HEALTH
 LOUISIANA DEPARTMENT OF STATE
 LA DEPT OF WILDLIFE AND FISHERIES
 VERNON WORKFORCE CENTER
 LA SHERIFFS PENSION AND RELIEF FUND
 Richland Parish Tax Assessors office
 THE SPRINGS OF RECOVERY ADOLESCENT PROGRAM
 HAMMOND DEVELOPMENTAL CENTER
 HOUMA-TERREBONNE HOUSING AUTHORITY
 METROPOLITAN DEVELOPMENTAL CENTER
 COLUMBIA DEVELOPMENT CENTER
 LINCOLN COUNCIL ON THE AGING
 26TH JUDICIAL DISTRICT PUBLIC DEFENDER
 LA OFFICE OF STATE PARKS
 LOUISIANA HOUSING FINANCE AGENCY
 SPECIAL EDUCATION DISTRICT NO.1 OF LAFOURCHE
 ELAYN HUNT CORRECTIONAL CENTER
 LSU AGCENTER EXTENSION SERVICE OFFICE
 18TH JDC-ALVIN BATISTE, JR JUDGE
 LOUISIANA BOARD OF CHIROPRACTIC EXAMINERS
 LOUISIANA STATE GOV. BIDS
 MHSD/CHARTRES-PONTCHARTRAIN BEHAVIOR HEALTH CENTER
 Covington Housing Authority
 Department of Children and Family Services/Child Welfare/West Jefferso
 Southeast Louisiana Hosp
 State of Louisiana Office of Legislative Auditor
 26 TH JUDICIAL COURT
 C.A.S.S.E.
 FLETCHER TECHNICAL COMMUNITY COLLEGE
 Orleans Parish Communication District
 LSUHSC/E.A. CONWAY MEDICAL CENTER
 Louisiana Board of Barbers Examiners
 LSU Bogalusa Medical
 Tahgipahoa Parish Sheriff's Office
 DCFS/CW/WEST JEFFERSON
 Ruston Housing Authority
 Account Type: Consolidated City/County
 City of New Orleans
 Account Type: Federal
 METRO NARCOTICS DEA TASK FORCE
 MONROE HOUSING AUTHORITY
 HOUSING AUTHORITY OF THE TOWN OF VINTON

STATE NOTICE ADDENDUM

career systems development corporation

first castle federal credit union

Account Type: Housing Authority

Vernon Parish Housing Authority

Haynesville Housing Authority

St. John the Baptist Housing Authority

Lake Arthur Housing Authority

MORGAN CITY HOUSING AUTHORITY

HOUSING AUTHORITY OF BOSSIER CITY

ST. LANDRY PARISH HOUSING AUTHORITY

HOUSING AUTHORITY OF JEFFERSON PARISH

SIMMESPORT HOUSING AUTHORITY

SOUTHWEST ACADIA HOUSING AUTHORITY

LMHA - LOUISIANA MANUFACTURED HOUSING ASSOCIATION

YOUNGSVILLE HOUSING AUTHORITY

Gibsland Housing Authority

Arcadia Housing Authority

Welsh Housing Authority

SABINE PARISH HOUSING AUTHORITY

PROVIDENCE HOUSE

Gueydan Housing Authority

Cottonport Housing Authority

Logansport Housing Authority

Mansfield Housing Authority

Jennings Housing Authority

White Castle Housing Authority

Housing Authority of St. Martinville

Ville Platte Housing Authority

East Carroll Housing Authority

State: OR

Account Type: K-12

VALLEY CATHOLIC SCHL

Bethel School District #52

Portland YouthBuilders

Fern Ridge School District 28J

MOLALLA RIVER ACADEMY

HIGH DESERT EDUCATION SERVICE DISTRICT

SOUTHWEST CHARTER SCHOOL

WHITEAKER MONTESSORI SCHOOL

CASCADES ACADEMY OF CENTRAL OREGON

NEAH-KAH-NIE DISTRICT NO.56

INTER MOUNTAIN ESD

STANFIELD SCHOOL DISTRICT

LA GRANDE SCHOOL DISTRICT

CASCADE SCHOOL DISTRICT

DUFUR SCHOOL DISTRICT NO.29

hillsboro school district

GASTON SCHOOL DISTRICT 511J

STATE NOTICE ADDENDUM

BEAVERTON SCHOOL DISTRICT
COUNTY OF YAMHILL SCHOOL DISTRICT 29
WILLAMINA SCHOOL DISTRICT
MCMINNVILLE SCHOOL DISTRICT NO.40
Sheridan School District 48J
THE CATLIN GABEL SCHOOL
NORTH WASCO CTY SCHOOL DISTRICT 21 - CHENOWITH
CENTRAL CATHOLIC HIGH SCHOOL
CANYONVILLE CHRISTIAN ACADEMY
GEN CONF OF SDA CHURCH WESTERN OR
PORTLAND ADVENTIST ACADEMY
OUR LADY OF THE LAKE SCHOOL
NYSSA SCHOOL DISTRICT NO. 26
ARLINGTON SCHOOL DISTRICT NO. 3
LIVINGSTONE ADVENTIST ACADEMY
Santiam Canyon SD 129J
WEST HILLS COMMUNITY CHURCH
BANKS SCHOOL DISTRICT
WILLAMETTE EDUCATION SERVICE DISTRICT
BAKER COUNTY SCHOOL DIST. 16J - MALHEUR ESD
HARNEY EDUCATION SERVICE DISTRICT
GREATER ALBANY PUBLIC SCHOOL DISTRICT
LAKE OSWEGO SCHOOL DISTRICT 7J
SOUTHERN OREGON EDUCATION SERVICE DISTRICT
SILVER FALLS SCHOOL DISTRICT
St Helens School District
DAYTON SCHOOL DISTRICT NO.8
Amity School District 4-J
SCAPPOOSE SCHOOL DISTRICT 1J
REEDSPORT SCHOOL DISTRICT
FOREST GROVE SCHOOL DISTRICT
DAVID DOUGLAS SCHOOL DISTRICT
LOWELL SCHOOL DISTRICT NO.71
TIGARD-TUALATIN SCHOOL DISTRICT
SHERWOOD SCHOOL DISTRICT 88J
RAINIER SCHOOL DISTRICT
NORTH CLACKAMAS SCHOOL DISTRICT
MONROE SCHOOL DISTRICT NO.1J
CHILDPEACE MONTESSORI
HEAD START OF LANE COUNTY
HARNEY COUNTY SCHOOL DIST. NO.3
NESTUCCA VALLEY SCHOOL DISTRICT NO.101
ARCHBISHOP FRANCIS NORBERT BLANCHET SCHOOL
LEBANON COMMUNITY SCHOOLS NO.9
MT.SCOTT LEARNING CENTERS
SEVEN PEAKS SCHOOL
DE LA SALLE N CATHOLIC HS
MULTISENSORY LEARNING ACADEMY

STATE NOTICE ADDENDUM

MITCH CHARTER SCHOOL
REALMS CHARTER SCHOOL
BAKER SCHOOL DISTRICT 5-J
PHILOMATH SCHOOL DISTRICT
CLACKAMAS EDUCATION SERVICE DISTRICT
CANBY SCHOOL DISTRICT
OREGON TRAIL SCHOOL DISTRICT NO.46
WEST LINN WILSONVILLE SCHOOL DISTRICT
MOLALLA RIVER SCHOOL DISTRICT NO.35
ESTACADA SCHOOL DISTRICT NO.108
GLADSTONE SCHOOL DISTRICT
ASTORIA SCHOOL DISTRICT 1C
SEASIDE SCHOOL DISTRICT 10
NORTHWEST REGIONAL EDUCATION SERVICE DISTRICT
VERNONIA SCHOOL DISTRICT 47J
SOUTH COAST EDUCATION SERVICE DISTRICT
COOS BAY SCHOOL DISTRICT NO.9
COOS BAY SCHOOL DISTRICT
NORTH BEND SCHOOL DISTRICT 13
COQUILLE SCHOOL DISTRICT 8
MYRTLE POINT SCHOOL DISTRICT NO.41
BANDON SCHOOL DISTRICT
BROOKING HARBOR SCHOOL DISTRICT NO.17-C
REDMOND SCHOOL DISTRICT
DESCHUTES COUNTY SD NO.6 - SISTERS SD
DOUGLAS EDUCATION SERVICE DISTRICT
ROSEBURG PUBLIC SCHOOLS
GLIDE SCHOOL DISTRICT NO.12
SOUTH UMPQUA SCHOOL DISTRICT #19
YONCALLA SCHOOL DISTRICT NO.32
ELKTON SCHOOL DISTRICT NO.34
DOUGLAS COUNTY SCHOOL DISTRICT 116
HOOD RIVER COUNTY SCHOOL DISTRICT
PHOENIX-TALENT SCHOOL DISTRICT NO.4
CENTRAL POINT SCHOOL DISTRICT NO. 6
JACKSON CO SCHOOL DIST NO.9
ROGUE RIVER SCHOOL DISTRICT NO.35
MEDFORD SCHOOL DISTRICT 549C
CULVER SCHOOL DISTRICT NO.
JEFFERSON COUNTY SCHOOL DISTRICT 509-J
GRANTS PASS SCHOOL DISTRICT 7
LOST RIVER JR/SR HIGH SCHOOL
KLAMATH FALLS CITY SCHOOLS
LANE COUNTY SCHOOL DISTRICT 4J
SPRINGFIELD SCHOOL DISTRICT NO.19
CRESWELL SCHOOL DISTRICT
SOUTH LANE SCHOOL DISTRICT 45J3
LANE COUNTY SCHOOL DISTRICT 69

STATE NOTICE ADDENDUM

SIUSLAW SCHOOL DISTRICT
SWEET HOME SCHOOL DISTRICT NO.55
LINN CO. SCHOOL DIST. 95C - SCIO SD
ONTARIO MIDDLE SCHOOL
GERVAIS SCHOOL DIST. #1
NORTH SANTIAM SCHOOL DISTRICT 29J
JEFFERSON SCHOOL DISTRICT
SALEM-KEIZER PUBLIC SCHOOLS
MT. ANGEL SCHOOL DISTRICT NO.91
MARION COUNTY SCHOOL DISTRICT 103 - WASHINGTON ES
MORROW COUNTY SCHOOL DISTRICT
MULTNOMAH EDUCATION SERVICE DISTRICT
GRESHAM-BARLOW SCHOOL DISTRICT
DALLAS SCHOOL DISTRICT NO. 2
CENTRAL SCHOOL DISTRICT 13J
St. Mary Catholic School
CROSSROADS CHRISTIAN SCHOOL
ST. ANTHONY SCHOOL
HERITAGE CHRISTIAN SCHOOL
BEND-LA PINE SCHOOL DISTRICT
GLENDALE SCHOOL DISTRICT
LINCOLN COUNTY SCHOOL DISTRICT
PORTLAND PUBLIC SCHOOLS
REYNOLDS SCHOOL DISTRICT
CENTENNIAL SCHOOL DISTRICT
NOBEL LEARNING COMMUNITIES
Three Rivers School District
Pedee School
Fern Ridge School District
JESUIT HIGH SCHL EXEC OFC
LASALLE HIGH SCHOOL
Southwest Christian School
Stayton Christian School
Willamette Christian School
Westside Christian High School
CS LEWIS ACADEMY
Portland America School
Forest Hills Lutheran School
Sunrise Preschool
Mosier Community School
Koreducators Lep High
Warrenton Hammond School District
Sutherlin School District
Malheur Elementary School District
Ontario School District
Parkrose School District 3
Riverdale School District 51J
Tillamook School District

STATE NOTICE ADDENDUM

Trinity Lutheran Church and School
 Siletz Valley School
 Madeleine School
 South Columbia Family School
 Corvallis School District 509J
 Falls City School District #57
 Portland Christian Schools
 Yamhill Carlton School District
 Imbler School District #11
 monument school
 St. Paul School District
 Ukiah School District 80R
 North Lake School District 14

Account Type: County

GILLIAM COUNTY OREGON
 HOUSING AUTHORITY OF CLACKAMAS COUNTY
 UMATILLA COUNTY, OREGON
 MULTNOMAH LAW LIBRARY
 CLACKAMAS COUNTY DEPT OF TRANSPORTATION
 CLATSOP COUNTY
 COLUMBIA COUNTY, OREGON
 COOS COUNTY HIGHWAY DEPARTMENT
 CROOK COUNTY ROAD DEPARTMENT
 CURRY COUNTY OREGON
 DESCHUTES COUNTY
 GILLIAM COUNTY
 GRANT COUNTY, OREGON
 HARNEY COUNTY SHERIFFS OFFICE
 HOOD RIVER COUNTY
 JACKSON COUNTY HEALTH AND HUMAN SERVICES
 Josephine County Sheriff
 KLAMATH COUNTY VETERANS SERVICE OFFICE
 LANE COUNTY
 LINN COUNTY
 MARION COUNTY , SALEM, OREGON
 MULTNOMAH COUNTY
 SHERMAN COUNTY
 WASCO COUNTY
 YAMHILL COUNTY
 WALLOWA COUNTY
 ASSOCIATION OF OREGON COUNTIES
 NAMI LANE COUNTY
 BENTON COUNTY
 DOUGLAS COUNTY
 JEFFERSON COUNTY
 LAKE COUNTY
 LINCOLN COUNTY
 POLK COUNTY

STATE NOTICE ADDENDUM

UNION COUNTY
 WASHINGTON COUNTY
 MORROW COUNTY
 Tillamook County Estuary
 Job Council
 Mckenzie Personnel Services
 Columbia Basin Care Facility
 BAKER CNTY GOVT
 TILLAMOOK CNTY
 Account Type: Non-Profit
 Rolling Hills Baptist Church
 Baker Elks
 Turtle Ridge Wildlife Center
 Grande Ronde Model Watershed Foundation
 Western Environmental Law Center
 Mercy Flights, Inc.
 HHoly Trinity Greek Orthodox Cathedral
 Beaverton Christians Church
 Oregon Humanities
 St. Pius X School
 Living Opportunities, Inc.
 Coos Art Museum
 OETC
 Merchants Exchange of Portland, Oregon
 Coalition for a Livable Future
 Human Solutions, Inc.
 The Wallace Medical Concern
 The Ross Ragland Theater and Cultural Center
 Cascade Health Solutions
 Umpqua Community Health Center
 ALZHEIMERS NETWORK OF OREGON
 NATIONAL WILD TURKEY FEDERATION
 TILLAMOOK ESTUARIES PARTNERSHIP
 LIFEWORKS NW
 COLLEGE HOUSING NORTHWEST
 PARALYZED VETERANS OF AMERICA
 Independent Development Enterprise Alliance
 MID-WILLAMETTE VALLEY COMMUNITY ACTION AGENCY, INC
 HALFWAY HOUSE SERVICES, INC.
 REDMOND PROFICIENCY ACADEMY
 OHSU FOUNDATION
 SHELTERCARE
 PRINGLE CREEK SUSTAINABLE LIVING CENTER
 PACIFIC INSTITUTES FOR RESEARCH
 Mental Health for Children, Inc.
 The Dreaming Zebra Foundation
 LAUREL HILL CENTER
 THE OREGON COMMUNITY FOUNDATION

STATE NOTICE ADDENDUM

OCHIN
WE CARE OREGON
SE WORKS
ENTERPRISE FOR EMPLOYMENT AND EDUCATION
OMNIMEDIX INSTITUTE
PORTLAND BUSINESS ALLIANCE
GATEWAY TO COLLEGE NATIONAL NETWORK
FOUNDATIONS FOR A BETTER OREGON
GOAL ONE COALITION
ATHENA LIBRARY FRIENDS ASSOCIATION
Coastal Family Health Center
CENTER FOR COMMUNITY CHANGE
STAND FOR CHILDREN
ST. VINCENT DEPAUL OF LANE COUNTY
EAST SIDE FOURSQUARE CHURCH
CORVALLIS MOUNTAIN RESCUE UNIT
InventSuccess
SHERIDAN JAPANESE SCHOOL FOUNDATION
MOSAIC CHURCH
HOUSING AUTHORITY OF LINCOLN COUNTY
RENEWABLE NORTHWEST PROJECT
INTERNATIONAL SUSTAINABLE DEVELOPMENT FOUNDATION
CONSERVATION BIOLOGY INSTITUTE
THE NATIONAL ASSOCIATION OF CREDIT MANAGEMENT-OREGON, INC.
BLACHLY LANE ELECTRIC COOPERATIVE
MORNING STAR MISSIONARY BAPTIST CHURCH
NORTHWEST FOOD PROCESSORS ASSOCIATION
INDEPENDENT INSURANCE AGENTS AND BROKERS OF OREGON
OREGON EDUCATION ASSOCIATION
HEARING AND SPEECH INSTITUTE INC
SALEM ELECTRIC
MORRISON CHILD AND FAMILY SERVICES
JUNIOR ACHIEVEMENT
CENTRAL BIBLE CHURCH
MID COLUMBIA MEDICAL CENTER-GREAT 'N SMALL
TRILLIUM FAMILY SERVICES, INC.
YWCA SALEM
PORTLAND ART MUSEUM
SAINT JAMES CATHOLIC CHURCH
SOUTHERN OREGON HUMANE SOCIETY
VOLUNTEERS OF AMERICA OREGON
CENTRAL DOUGLAS COUNTY FAMILY YMCA
METROPOLITAN FAMILY SERVICE
OREGON MUSUEM OF SCIENCE AND INDUSTRY
FIRST UNITARIAN CHURCH
ST. ANTHONY CHURCH
Good Shepherd Medical Center
Salem Academy

STATE NOTICE ADDENDUM

ST VINCENT DE PAUL
 OUTSIDE IN
 UNITED CEREBRAL PALSY OF OR AND SW WA
 WILLAMETTE VIEW INC.
 PORTLAND HABILITATION CENTER, INC.
 OREGON STATE UNIVERSITY ALUMNI ASSOCIATION
 ROSE VILLA, INC.
 NORTHWEST LINE JOINT APPRENTICESHIP & TRAINING COMMITTEE
 BOYS AND GIRLS CLUBS OF PORTLAND METROPOLITAN AREA
 Oregon Research Institute
 WILLAMETTE LUTHERAN HOMES, INC
 LANE MEMORIAL BLOOD BANK
 PORTLAND JEWISH ACADEMY
 LANECO FEDERAL CREDIT UNION
 GRANT PARK CHURCH
 ST. MARYS OF MEDFORD, INC.
 US CONFERENCE OF MENONNITE BRETHREN CHURCHES
 FAITHFUL SAVIOR MINISTRIES
 OREGON CITY CHURCH OF THE NAZARENE
 OREGON COAST COMMUNITY ACTION
 NORTHWEST REGIONAL EDUCATIONAL LABORATORY
 COMMUNITY ACTION TEAM, INC.
 EUGENE SYMPHONY ASSOCIATION, INC.
 STAR OF HOPE ACTIVITY CENTER INC.
 SPARC ENTERPRISES
 SOUTHERN OREGON CHILD AND FAMILY COUNCIL, INC.
 SALEM ALLIANCE CHURCH
 Lane Council of Governments
 FORD FAMILY FOUNDATION
 TRAILS CLUB
 NEWBERG FRIENDS CHURCH
 WOODBURN AREA CHAMBER OF COMMERCE
 CONTEMPORARY CRAFTS MUSEUM AND GALLERY
 CITY BIBLE CHURCH
 OREGON LIONS SIGHT & HEARING FOUNDATION
 PORTLAND WOMENS CRISIS LINE
 THE SALVATION ARMY - CASCADE DIVISION
 WILLAMETTE FAMILY
 WHITE BIRD CLINIC
 GOODWILL INDUSTRIES OF LANE AND SOUTH COAST COUNTIES
 PLANNED PARENTHOOD OF SOUTHWESTERN OREGON
 HOUSING NORTHWEST
 OREGON ENVIRONMENTAL COUNCIL
 LOAVES & FISHES CENTERS, INC.
 FAITH CENTER
 Bob Belloni Ranch, Inc.
 GOOD SHEPHERD COMMUNITIES
 SACRED HEART CATHOLIC DAUGHTERS

STATE NOTICE ADDENDUM

HELP NOW! ADVOCACY CENTER
TENAS ILLAHEE CHILDCARE CENTER
SUNRISE ENTERPRISES
LOOKING GLASS YOUTH AND FAMILY SERVICES
SERENITY LANE
EAST HILL CHURCH
LA GRANDE UNITED METHODIST CHURCH
COAST REHABILITATION SERVICES
Edwards Center Inc
ALVORD-TAYLOR INDEPENDENT LIVING SERVICES
NEW HOPE COMMUNITY CHURCH
KLAMATH HOUSING AUTHORITY
QUADRIPLIGICS UNITED AGAINST DEPENDENCY, INC.
SPONSORS, INC.
COLUMBIA COMMUNITY MENTAL HEALTH
ADDICTIONS RECOVERY CENTER, INC
METRO HOME SAFETY REPAIR PROGRAM
OREGON SUPPORTED LIVING PROGRAM
SOUTH COAST HOSPICE, INC.
ALLFOURONE/CRESTVIEW CONFERENCE CTR.
The International School
REBUILDING TOGETHER - PORTLAND INC.
PENDLETON ACADEMIES
PACIFIC FISHERY MANAGEMENT COUNCIL
DOGS FOR THE DEAF, INC.
PUBLIC DEFENDER SERVICES OF LANE COUNTY, INC.
EMMAUS CHRISTIAN SCHOOL
DELIGHT VALLEY CHURCH OF CHRIST
SAINT CATHERINE OF SIENA CHURCH
PORT CITY DEVELOPMENT CENTER
VIRGINIA GARCIA MEMORIAL HEALTH CENTER
CENTRAL CITY CONCERN
CANBY FOURSQUARE CHURCH
EMERALD PUD
VERMONT HILLS FAMILY LIFE CENTER
BENTON HOSPICE SERVICE
INTERNATIONAL SOCIETY FOR TECHNOLOGY IN EDUCATION
COMMUNITY CANCER CENTER
OPEN MEADOW ALTERNATIVE SCHOOLS, INC.
CASCADIA BEHAVIORAL HEALTHCARE
WILD SALMON CENTER
BROAD BASE PROGRAMS INC.
SUNNYSIDE FOURSQUARE CHURCH
RELEVANT LIFE CHURCH
211INFO
SONRISE CHURCH
LIVING WAY FELLOWSHIP
Women's Safety & Resource Center

STATE NOTICE ADDENDUM

SEXUAL ASSAULT RESOURCE CENTER
IRCO
NORTHWEST YOUTH CORPS
TILLAMOOK CNTY WOMENS CRISIS CENTER
SECURITY FIRST CHILD DEVELOPMENT CENTER
CLASSROOM LAW PROJECT
YOUTH GUIDANCE ASSOC.
PREGNANCY RESOUCE CENTERS OF GRETER PORTLAND
ELMIRA CHURCH OF CHRIST
JASPER MOUNTAIN
ACUMENTRA HEALTH
WORKSYSTEMS INC
COVENANT CHRISTIAN HOOD RIVER
OREGON DONOR PROGRAM
NAMI OREGON
OLIVET BAPTIST CHURCH
SILVERTON AREA COMMUNITY AID
CONFEDERATED TRIBES OF GRAND RONDE
CENTRAL OREGON COMMUNITY ACTION AGENCY NETWORK
CATHOLIC COMMUNITY SERVICES
NEW AVENUES FOR YOUTH INC
LA CLINICA DEL CARINO FAMILY HEALTH CARE CENTER
DECISION SCIENCE RESEARCH INSTITUTE, INC.
WESTERN STATES CENTER
HIV ALLIANCE, INC
PARTNERSHIPS IN COMMUNITY LIVING, INC.
FANCONI ANEMIA RESEARCH FUND INC.
BLIND ENTERPRISES OF OREGON
OREGON BALLET THEATRE
SMART
All God's Children International
FARMWORKER HOUISNG DEV CORP
UMPQUA COMMUNITY DEVELOPMENT CORPORATION
REGIONAL ARTS AND CULTURE COUNCIL
THE EARLY EDUCATION PROGRAM, INC.
MACDONALD CENTER
EVERGREEN AVIATION MUSEUM AND CAP. MICHAEL KING.
SELF ENHANCEMENT INC.
FRIENDS OF THE CHILDREN
SOUTH LANE FAMILY NURSERY DBA FAMILY RELIEF NURSE
COMMUNITY VETERINARY CENTER
PORTLAND SCHOOLS FOUNDATION
SUSTAINABLE NORTHWEST
OREGON DEATH WITH DIGNITY
BIRCH COMMUNITY SERVICES, INC.
BAY AREA FIRST STEP, INC.
OSLC COMMUNITY PROGRAMS
EN AVANT, INC.

STATE NOTICE ADDENDUM

ASHLAND COMMUNITY HOSPITAL
 NORTHWEST ENERGY EFFICIENCY ALLIANCE
 BONNEVILLE ENVIRONMENTAL FOUNDATION
 SUMMIT VIEW COVENANT CHURCH
 SALMON-SAFE INC.
 BETHEL CHURCH OF GOD
 PROVIDENCE HOOD RIVER MEMORIAL HOSPITAL
 SAINT ANDREW NATIVITY SCHOOL
 BARLOW YOUTH FOOTBALL
 SPOTLIGHT THEATRE OF PLEASANT HILL
 FAMILIES FIRST OF GRANT COUNTY, INC.
 TOUCHSTONE PARENT ORGANIZATION
 CANCER CARE RESOURCES
 CASCADIA REGION GREEN BUILDING COUNCIL
 SHERMAN DEVELOPMENT LEAGUE, INC.
 SCIENCEWORKS
 WORD OF LIFE COMMUNITY CHURCH
 SOCIAL VENTURE PARTNERS PORTLAND
 OREGON PROGRESS FORUM
 CENTER FOR RESEARCH TO PRACTICE
 WESTERN RIVERS CONSERVANCY
 UNITED WAY OF THE COLUMBIA WILLAMETTE
 EUGENE BALLETT COMPANY
 EAST WEST MINISTRIES INTERNATIONAL
 EDUCATIONAL POLICY IMPROVEMENT CENTER
 North Pacific District of Foursquare Churches
 CATHOLIC CHARITIES
 FIRST CHURCH OF THE NAZARENE
 WESTSIDE BAPTIST CHURCH
 UNION GOSPEL MISSION
 GRACE BAPTIST CHURCH
 COMMUNITY ACTION ORGANIZATION
 OUTSIDE IN
 MAKING MEMORIES BREAST CANCER FOUNDATION, INC.
 COMMUNITY HEALTH CENTER, INC
 Greater Portland INC
 Boys & Girls Club of Corvallis
 PDX Wildlife
 Viking Sal Senior Center
 Albany Partnership for Housing and Community Development
 Polk Soil and Water Conservation District
 Street Ministry
 First Baptist Church
 Portland Community Reinvestment Initiatives, Inc.
 College United Methodist Church
 Oregon Social Learning Center
 environmental law alliance worldwide
 Community in Action

STATE NOTICE ADDENDUM

RFP2000000330

Safe Harbors
Pacific Classical Ballet
Depaul Industries
African American Health Coalition
Ministerio International Casa
Jesus Prayer Book
Workforce Northwest Inc
Coalition Of Community Health
New Paradise Worship Center
River Network
CCI Enterprises Inc
Oregon Nurses Association
GOODWILL INDUSTRIES OF THE COLUMBIA WILLAMETTE
Mount Angel Abbey
YMCA OF ASHLAND
YMCA OF COLUMBIA-WILLAMETTE ASSOCIATION SERVICES
Multnomah Law Library
Friends Of Tryon Creek State P
Ontrack Inc.
Calvin Presbyterian Church
HOLT INTL CHILD
St John The Baptist Catholic
Portland Foursquare Church
Portland Christian Center
Church Extension Plan
Occu Afghanistan Relief Effort
EUGENE FAMILY YMCA
Christ The King Parish and School
Congregation Neveh Shalom
Newberg Christian Church
First United Methodist Church
Zion Lutheran Church
Hoodview Christian Church
Southwest Bible Church
Community Works Inc
Masonic Lodge Pearl 66
Molalla Nazarene Church
Transition Projects, Inc
St Michaels Episcopal Church
Saint Johns Catholich Church
Access Inc
Step Forward Activities Inc
Lane Arts Council
Community Learning Center
Old Mill Center for Children and Families
Sunny Oaks Inc
Little Flower Development Center
Hospice Center Bend La Pine

STATE NOTICE ADDENDUM

Westside Foursquare Church
 Relief Nursery Inc
 Morning Star Community Church
 Providence Health System
 Holy Trinity Catholic Church
 Holy Redeemer Catholic Church
 Alliance Bible Church
 Mid Columbia Childrens Council
 Intergral Youth Services
 Our Redeemer Lutheran Church
 Kbps Public Radio
 Skyball Salem Keizer Youth Bas
 Open Technology Center
 Grace Chapel
 CHILDREN'S MUSEUM 2ND
 Oregon District 7 Little League
 Portland Schools Alliance
 My Fathers House
 Solid Rock
 West Chehalem Friends Church
 Eugene Creative Care
 Guide Dogs For The Blind
 Children Center At Trinity
 St. Katherine's Catholic Church
 Scottish Rite
 THE NEXT DOOR
 NATIONAL PSORIASIS FOUNDATION
 NEW BEGINNINGS CHRISTIAN CENTER
 HIGHLAND UNITED CHURCH OF CHRIST
 OREGON REPERTORY SINGERS
 HIGHLAND HAVEN
 FAIR SHARE RESEARCH AND EDUCATION FUND
 First Baptist Church of Enterprise
 Oregon Nikkei Endowment
 Eastern Oregon Alcoholism Foundation
 Grantmakers for Education
 The ALS Association Oregon and SW Washington Chapter
 Children's Relief Nursery
 Energy Trust of Oregon
 Oregon Psychoanalytic Center
 Store to Door
 Depaul Industries
 Union County Economic Development Corp.
 Camelto Theatre Company
 Camp Fire Columbia
 TAKE III OUTREACH
 Sandy Seventh-day Adventist Church
 1000 FRIENDS OF OREGON

STATE NOTICE ADDENDUM

NAMI of Washington County
 Temple Beth Israel
 Albertina Kerr Centers
 St. Matthew Catholic School
 Serendipity Center Inc
 Ashland Art Center
 DOUGLAS FOREST PROTECTIVE
 Oregon Lyme Disease Network
 Ecotrust
 SPECIAL MOBILITY SERVICES
 Portland Oregon Visitors Association
 Grace Lutheran School
 Western Mennonite School

Account Type: College and University

OREGON UNIVERSITY SYSTEM
 WESTERN STATES CHIROPRACTIC COLLEGE
 GEORGE FOX UNIVERSITY
 LEWIS AND CLARK COLLEGE
 PACIFIC UNIVERSITY
 REED COLLEGE
 WILLAMETTE UNIVERSITY
 LINFIELD COLLEGE
 MULTNOMAH BIBLE COLLEGE
 NORTHWEST CHRISTIAN COLLEGE
 NATIONAL COLLEGE OF NATURAL MEDICINE
 BLUE MOUNTAIN COMMUNITY COLLEGE
 PORTLAND STATE UNIV.
 CLACKAMAS COMMUNITY COLLEGE
 MARYLHURST UNIVERSITY
 OREGON HEALTH AND SCIENCE UNIVERSITY
 BIRTHINGWAY COLLEGE OF MIDWIFERY
 CONCORDIA UNIV
 Marylhurst University
 Corban College
 Oregon Center For Advanced T

Account Type: Other

eickhoff dev co inc
 Illinois Valley Fire District
 Life Flight Network LLC
 TRI-COUNTY HEALTH CARE SAFETY NET ENTERPRISE
 COVENANT RETIREMENT COMMUNITIES
 PENTAGON FEDERAL CREDIT UNION
 SAIF CORPORATION
 MID-COLUMBIA CENTER FOR LIVING
 GOLD BEACH POLICE DEPARTMENT
 GREATER HILLSBORO AREA CHAMBER OF COMMERCE
 LANE ELECTRIC COOPERATIVE
 USAGENCIES CREDIT UNION

STATE NOTICE ADDENDUM

DOUGLAS ELECTRIC COOPERATIVE, INC.
 ROGUE FEDERAL CREDIT UNION
 PACIFIC CASCADE FEDERAL CREDIT UNION
 PACIFIC STATES MARINE FISHERIES COMMISSION
 NORTH BEND CITY- COOS/URRY HOUSING AUTHORITY
 LOCAL GOVERNMENT PERSONNEL INSTITUTE
 MID COLUMBIA COUNCIL OF GOVERNMENTS
 TRAINING EMPLOYMENT CONSORTIUM
 CLACKAMAS RIVER WATER
 GRANTS PASS MANAGEMENT SERVICES, DBA
 SPIRIT WIRELESS
 SISKIYOU INITIATIVE
 Clatskanie People's Utility District
 CITY/COUNTY INSURANCE SERVICE
 PIONEER COMMUNITY DEVELOPMENT
 Cornerstone Association Inc
 COMMUNITY CYCLING CENTER
 Portland Impact
 Eagle Fern Camp
 NORTHWEST VINTAGE CAR AND MOTORCYCLE
 K Churchill Estates
 KLAMATH FAMILY HEAD START
 MULTNOMAH DEFENDERS INC
 RIVER CITY DANCERS
 KEIZER EAGLES AERIE 3895
 HUMANE SOCIETY OF REDMOND
 CSC HEAD START
 SPRINGFIELD UTILITY BOARD
 Oregon Public Broadcasting
 Apostolic Church of Jesus Christ

Account Type: Unknown

Ppmc Education Committee

NPKA

Shangri La

Cvalco

P E C I

Oregon Permit Technical Association

Pgma/Cathie Bourne

Astra

Beit Hallel

Account Type: City Special District

Molalla Rural Fire Protection District

MONMOUTH - INDEPENDENCE NETWORK

MALIN COMMUNITY PARK AND RECREATION DISTRICT

TILLAMOOK PEOPLES UTILITY DISTRICT

GLADSTONE POLICE DEPARTMENT

THE NEWPORT PARK AND RECREATION CENTER

RIVERGROVE WATER DISTRICT

STATE NOTICE ADDENDUM

WEST VALLEY HOUSING AUTHORITY
 TUALATIN VALLEY FIRE & RESCUE
 GASTON RURAL FIRE DEPARTMENT
 CITY COUNTY INSURANCE SERVICES
 METRO

Roseburg Police Department
 SOUTH SUBURBAN SANITARY DISTRICT
 OAK LODGE SANITARY DISTRICT
 SOUTH FORK WATER BOARD
 SUNSET EMPIRE PARK AND RECREATION
 Tillamook Urban Renewal Agency
 Boardman Rural Fire Protection District

Account Type: Independent Special District
 Silverton Fire District

Lewis and Clark Rural Fire Protection District
 Rainbow Water District
 METROPOLITAN EXPOSITION-RECREATION COMMISSION
 REGIONAL AUTOMATED INFORMATION NETWORK
 OAK LODGE WATER DISTRICT
 THE PORT OF PORTLAND
 WILLAMALANE PARK AND RECREATION DISTRICT
 TUALATIN VALLEY WATER DISTRICT
 UNION SOIL & WATER CONSERVATION DISTRICT
 LANE EDUCATION SERVICE DISTRICT
 TUALATIN HILLS PARK AND RECREATION DISTRICT
 PORT OF SIUSLAW
 CHEHALEM PARK AND RECREATION DISTRICT
 PORT OF ST HELENS
 LANE TRANSIT DISTRICT
 CENTRAL OREGON INTERGOVERNMENTAL COUNCIL
 HOODLAND FIRE DISTRICT NO.74
 WEST MULTNOMAH SOIL AND WATER CONSERVATION DISTRICT
 SALEM AREA MASS TRANSIT DISTRICT
 Banks Fire District #13
 KLAMATH COUNTY 9-1-1
 GLENDALE RURAL FIRE DISTRICT
 COLUMBIA 911 COMMUNICATIONS DISTRICT
 NW POWER POOL
 Lowell Rural Fire Protection District
 TriMet Transit
 La Pine Park & Recreation District
 Siuslaw Public Library District
 Columbia River Fire & Rescue
 Seal Rock Water District
 Tillamook Fire District
 Jefferson Park and Recreation

STATE NOTICE ADDENDUM

Account Type: City

Brookings Fire / Rescue

City of Veneta

CITY OF DAMASCUS

Hermiston Fire & Emergency Svcs

CEDAR MILL COMMUNITY LIBRARY

CITY OF LAKE OSWEGO

EUGENE WATER & ELECTRIC BOARD

LEAGUE OF OREGON CITIES

CITY OF SANDY

CITY OF ASTORIA OREGON

CITY OF BEAVERTON

CITY OF BOARDMAN

CITY OF CANBY

CITY OF CANYONVILLE

CITY OF CENTRAL POINT POLICE DEPARTMENT

CITY OF CLATSKANIE

CITY OF CONDON

CITY OF COOS BAY

CITY OF CORVALLIS

CITY OF CRESWELL

CITY OF ECHO

CITY OF ESTACADA

CITY OF EUGENE

CITY OF FAIRVIEW

CITY OF GEARHART

CITY OF GOLD HILL

CITY OF GRANTS PASS

CITY OF GRESHAM

CITY OF HILLSBORO

CITY OF HOOD RIVER

CITY OF JOHN DAY

CITY OF KLAMATH FALLS

CITY OF LA GRANDE

CITY OF MALIN

CITY OF MCMINNVILLE

CITY OF HALSEY

CITY OF MEDFORD

CITY OF MILL CITY

CITY OF MILWAUKIE

CITY OF MORO

CITY OF MOSIER

CITY OF NEWBERG

CITY OF OREGON CITY

CITY OF PILOT ROCK

CITY OF POWERS

RAINIER POLICE DEPARTMENT

CITY OF REEDSPORT

STATE NOTICE ADDENDUM

CITY OF RIDDLE
CITY OF SCAPPOOSE
CITY OF SEASIDE
CITY OF SILVERTON
CITY OF STAYTON
City of Troutdale
CITY OF TUALATIN, OREGON
CITY OF WARRENTON
CITY OF WEST LINN/PARKS
CITY OF WOODBURN
CITY OF TIGARD, OREGON
CITY OF AUMSVILLE
CITY OF PORT ORFORD
CITY OF EAGLE POINT
CITY OF WOOD VILLAGE
St. Helens, City of
CITY OF WINSTON
CITY OF COBURG
CITY OF NORTH PLAINS
CITY OF GERVAIS
CITY OF YACHATS
FLORENCE AREA CHAMBER OF COMMERCE
PORTLAND DEVELOPMENT COMMISSION
CITY OF CANNON BEACH OR
CITY OF ST. PAUL
CITY OF ADAIR VILLAGE
CITY OF WILSONVILLE
HOUSING AUTHORITY OF THE CITY OF SALEM
CITY OF HAPPY VALLEY
CITY OF SHADY COVE
CITY OF LAKESIDE
CITY OF MILLERSBURG
CITY OF GATES
KEIZER POLICE DEPARTMENT
CITY OF DUNDEE
CITY OF AURORA
THE CITY OF NEWPORT
CITY OF ALBANY
CITY OF ASHLAND
CITY OF LEBANON
CITY OF PORTLAND
CITY OF SALEM
CITY OF SPRINGFIELD
CITY OF BURNS
CITY OF COTTAGE GROVE
CITY OF DALLAS
CITY OF FALLS CITY
CITY OF PHOENIX

STATE NOTICE ADDENDUM

CITY OF PRAIRIE CITY
 CITY OF REDMOND
 CITY OF SANDY
 CITY OF SHERWOOD
 CITY OF GRANTS PASS
 City of Monmouth
 City of Philomath
 City of Lake Oswego
 Woodburn City Of
 NW PORTLAND INDIAN HEALTH BOARD
 Portland Patrol Services
 City Of Bend
 City Of Coquille
 City Of Molalla
 City Of North Bend
 Columbia Gorge Community
 City of St. Helens
 Toledo Police Department
 City of Independence
 City of Baker City
 City of Ontario
 North Lincoln Fire & Rescue #1
 CITY OF LINCOLN CITY
 Account Type: County Special District
 Netarts-Oceanside RFPD
 Rogue River Fire District
 Southern Coos Hospital
 Oregon Cascades West Council of Governments
 MULTONAH COUNTY DRAINAGE DISTRICT #1
 PORT OF BANDON
 OR INT'L PORT OF COOS BAY
 DESCHUTES COUNTY RFPD NO.2
 YOUNGS RIVER LEWIS AND CLARK WATER DISTRICT
 HOUSING AUTHORITY AND COMMUNITY SERVICES AGENCY
 CENTRAL OREGON IRRIGATION DISTRICT
 MARION COUNTY FIRE DISTRCT #1
 COLUMBIA RIVER PUD
 SANDY FIRE DISTRICT NO. 72
 BAY AREA HOSPITAL DISTRICT
 NEAH KAH NIE WATER DISTRICT
 PORT OF UMPQUA
 EAST MULTNOMAH SOIL AND WATER CONSERVANCY
 Benton Soil & Water Conservation District
 DESCHUTES PUBLIC LIBRARY SYSTEM
 CLEAN WATER SERVICES
 PARROTT CREEK CHILD & FAM
 South Lane County Fire And Rescue

STATE NOTICE ADDENDUM

Account Type: Community College

CENTRAL OREGON COMMUNITY COLLEGE
 UMPQUA COMMUNITY COLLEGE
 LANE COMMUNITY COLLEGE
 MT. HOOD COMMUNITY COLLEGE
 LINN-BENTON COMMUNITY COLLEGE
 SOUTHWESTERN OREGON COMMUNITY COLLEGE
 PORTLAND COMMUNITY COLLEGE
 CHEMEKETA COMMUNITY COLLEGE
 ROGUE COMMUNITY COLLEGE
 COLUMBIA GORGE COMMUNITY COLLEGE
 TILLAMOOK BAY COMMUNITY COLLEGE
 KLAMATH COMMUNITY COLLEGE DISTRICT
 OREGON COMMUNITY COLLEGE ASSOCIATION
 Oregon Coast Community College

Account Type: State Agency

Office of the Ong Term Care Ombudsman
 OREGON TOURISM COMMISSION
 OREGON STATE POLICE
 OFFICE OF THE STATE TREASURER
 OREGON DEPT. OF EDUCATION
 SEIU LOCAL 503, OPEU
 OREGON DEPARTMENT OF FORESTRY
 OREGON STATE DEPT OF CORRECTIONS
 OREGON CHILD DEVELOPMENT COALITION
 OFFICE OF MEDICAL ASSISTANCE PROGRAMS
 OREGON OFFICE OF ENERGY
 OREGON STATE BOARD OF NURSING
 BOARD OF MEDICAL EXAMINERS
 OREGON LOTTERY
 OREGON BOARD OF ARCHITECTS
 SANTIAM CANYON COMMUNICATION CENTER
 OREGON DEPT OF TRANSPORTATION
 OREGON TRAVEL INFORMATION COUNCIL
 OREGON DEPARTMENT OF EDUCATION
 Oregon Tradeswomen
 Oregon Convention Center
 OREGON SCHL BRDS ASSOCIAT
 OREGON DEPARTMENT OF HUMAN SERVICES
 CARE OREGON
 Kdrv Channel 12
 Central Oregon Home Health and Hos
 Oregon Health Care Quality Cor
 Opta Oregon Permit Technician
 STATE OF OREGON

STATE NOTICE ADDENDUM

Account Type: Federal
US FISH AND WILDLIFE SERVICE
USDA Forest Service
Yellowhawk Tribal Health Center

Account Type: Housing Authority
HOUSING AUTHORITY OF PORTLAND
MARION COUNTY HOUSING AUTHORITY
Housing Authority of Yamhill County

**FEMA STANDARD TERMS AND CONDITIONS ADDENDUM
FOR CONTRACTS AND GRANTS**

If any purchase made under the Master Agreement is funded in whole or in part by Federal Emergency Management Agency ("FEMA") grants, Contractor shall comply with all federal laws and regulations applicable to the receipt of FEMA grants, including, but not limited to the contractual procedures set forth in Title 44 of the Code of Federal Regulations, Part 13 ("44 CFR 13").

In addition, Contractor agrees to the following specific provisions:

1. Pursuant to 44 CFR 13.36(i)(1), University is entitled to exercise all administrative, contractual, or other remedies permitted by law to enforce Contractor's compliance with the terms of this Master Agreement, including but not limited to those remedies set forth at 44 CFR 13.43.
2. Pursuant to 44 CFR 13.36(i)(2), University may terminate the Master Agreement for cause or convenience in accordance with the procedures set forth in the Master Agreement and those provided by 44 CFR 13.44.
3. Pursuant to 44 CFR 13.36(i)(3)-(6)(12), and (13), Contractor shall comply with the following federal laws:
 - a. Executive Order 11246 of September 24, 1965, entitled "Equal Employment Opportunity," as amended by Executive Order 11375 of October 13, 1967, and as supplemented in Department of Labor ("DOL") regulations (41 CFR Ch. 60);
 - b. Copeland "Anti-Kickback" Act (18 U.S.C. 874), as supplemented in DOL regulations (29 CFR Part 3);
 - c. Davis-Bacon Act (40 U.S.C. 276a-276a-7) as supplemented by DOL regulations (29 CFR Part 5);
 - d. Section 103 and 107 of the Contract Work Hours and Safety Standards Act (40 U.S.C. 327-330) as supplemented by DOL regulations (29 CFR Part 5);
 - e. Section 306 of the Clean Air Act (42 U.S.C. 1857(h), section 508 of the Clean Water Act (33 U.S.C. 1368), Executive Order 11738, and Environmental Protection Agency regulations (40 CFR part 15); and
 - f. Mandatory standards and policies relating to energy efficiency which are contained in the state energy conservation plan issued in compliance with the Energy Policy and Conservation Act (Pub. L. 94-163, 89 Stat. 871).
4. Pursuant to 44 CFR 13.36(i)(7), Contractor shall comply with FEMA requirements and regulations pertaining to reporting, including but not limited to those set forth at 44 CFR 40 and 41.

**FEMA STANDARD TERMS AND CONDITIONS ADDENDUM
FOR CONTRACTS AND GRANTS**

5. Pursuant to 44 CFR 13.36(i)(8), Contractor agrees to the following provisions regarding patents:
 - a. All rights to inventions and/or discoveries that arise or are developed, in the course of or under this Agreement, shall belong to the University and be disposed of in accordance with University policy. The University, at its own discretion, may file for patents in connection with all rights to any such inventions and/or discoveries.

6. Pursuant to 44 CFR 13.36(i)(9), Contractor agrees to the following provisions, regarding copyrights:
 - a. If this Agreement results in any copyrightable material or inventions, in accordance with 44 CFR 13.34, FEMA reserves a royalty-free, nonexclusive, and irrevocable license to reproduce, publish or otherwise use, for Federal Government purposes:
 - (1) The copyright in any work developed under a grant or contract; and
 - (2) Any rights of copyright to which a grantee or a contractor purchases ownership with grant support.

7. Pursuant to 44 CFR 13.36(i)(10), Contractor shall maintain any books, documents, papers, and records of the Contractor which are directly pertinent to this Master Agreement. At any time during normal business hours and as often as University deems necessary, Contractor shall permit University, FEMA, the Comptroller General of United States, or any of their duly authorized representatives to inspect and photocopy such records for the purpose of making audit, examination, excerpts, and transcriptions.

8. Pursuant to 44 CFR 13.36(i)(11), Contractor shall retain all required records for three years after FEMA or University makes final payments and all other pending matters are closed. In addition, Contractor shall comply with record retention requirements set forth in 44 CFR 13.42.

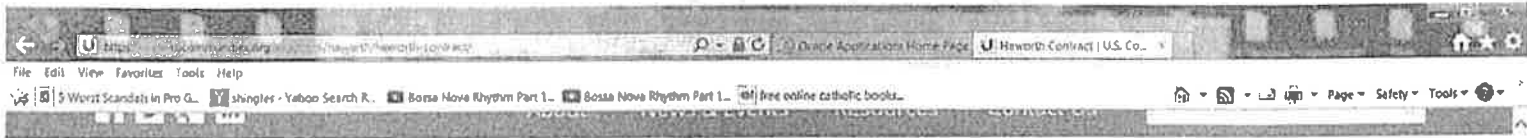

U.S. COMMUNITIES®
An OMNIA Partner

PRODUCTS & SOLUTIONS CONTRACT DOCUMENTS

REGISTER LOGIN

Haworth Contract

Home [Haworth](#) [Haworth Contract](#)

REGISTER
or Sign In

Solutions

BY SUPPLIER [show all ->](#)

BY CATEGORY

- Facilities
- Office & School
- Specialty
- Technology

Office Furniture

Lead Agency:
Fairfax County, Virginia

Contract Number:
4400003402

4 year initial term, January 1, 2013 to December 31, 2016
Option to renew for (4) additional (1) year periods or any combination thereof

The contract is renewed for three (3) years, effective January 1, 2018 through December 31, 2020

Contract Documents:

- ① Contract 4400003402
- ② Notice of Award
- ③ Haworth Multiple Award Discount Pricing
- ④ Haworth Committed Discount Pricing
- ⑤ Contract Amendments

RFP Documents:



Haworth Contract

[Home](#) > [Haworth](#) > [Haworth Contract](#)

Office Furniture

Lead Agency:
Fairfax County, Virginia

Contract Number:
4400003402

4 year initial term, January 1, 2013 to December 31, 2016
Option to renew for (4) additional (1) year periods or any combination thereof
The contract is renewed for three (3) years, effective January 1, 2018 through December 31, 2020



Contract Updates

Contract Amendment 17 added on October 15, 2018

REQUEST INFORMATION

Postings

Number of suppliers who responded to RFP: 16

Posting Information:	Date Posted:
U.S. Communities: Current Solicitations	June 12, 2012 to July 19, 2012
Canadian MERX Public Tenders	June 12, 2012 to July 19, 2012
Onvia Demand Star	June 12, 2012 to July 19, 2012
Fairfax County	June 12, 2012 to July 19, 2012
Association of Oregon Counties	June 12, 2012 to July 19, 2012
State of Hawaii and Oregon	June 12, 2012 to July 19, 2012

Contract Documents:

- [Contract 4400003402](#)
- [Notice of Award](#)
- [Haworth Multiple Award Discount Pricing](#)
- [Haworth Committed Discount Pricing](#)
- [Contract Amendments](#)

RFP Documents:

- [Request for Proposal 2000000330 Addenda](#)
- [RFP Posting Document](#)

Solutions

BY SUPPLIER ([show all ->](#))

BY CATEGORY

- [Facilities](#)
- [Office & School](#)
- [Specialty](#)
- [Technology](#)

Main Menu

JUMP TO:

- [Solicitations](#)
- [About](#)
- [News & Events](#)
- [Resources](#)
- [Contact Us](#)
- [Education Purchasing](#)
- [Government Purchasing](#)
- [Nonprofit](#)
- [Go Green Program](#)

Getting Started

- Program Overview
- How It Works
- FAQs

Why Use U.S. Communities

- What Makes Us Different
- Webinars & Events
- Supplier Commitments

Discounts on Brands

- Products & Suppliers
- Online Marketplace
- Solicitations

Over 55,000 agencies trust U.S.

- Who Uses U.S. Communities?
- Cooperative Standards
- State Statutes

[CONTACT US](#)

[BECOME A SUPPLIER](#)

[ABOUT US](#)

[TERMS OF USE](#)

[PRIVACY](#)

[MICPA](#)

© 2019 U.S. Communities | All Rights Reserved.

Attachment 'B'

AMENDMENTS

5



County of Fairfax, Virginia

AMENDMENT

OCT 12 2018

AMENDMENT NO. 17

CONTRACT TITLE: Office Furniture and Related Services

CONTRACTOR

SUPPLIER CODE

CONTRACT NO.

Haworth Inc.
One Haworth Center
Holland, MI 49423

1000011672

4400003402

By mutual agreement, contract 4400003402 is amended as indicated below effective November 1, 2018:

1. PRICE ADJUSTMENT/INCREASE:
Haworth Inc. is implementing a price list adjustment effective November 1, 2018. While some prices are not changing, the overall average increase on the price list will be 3.5%.
2. DELETE:
TecCrete and Tecnika products are hereby deleted from the contract as they are no longer being produced by Haworth.

All other prices, discounts, terms and conditions remain the same.

Steve Pierson, CPPB
Contracts Manager

 Cathy A. Muse, CPPO
Director/County Purchasing Agent

DISTRIBUTION

Department of Finance – Accounts Payable/e
Facilities Management Dept. – Bill Robinson/e
Facilities Management Dept. – Rhinda Edwards/e
U. S. Communities – Tyler McCall – tmccall@uscommunities.org

Contractor (Cyndi.kamps@haworth.com)
Contract Specialist – M. Blair
Asst. Contract Spec., Team 2

Department of Procurement & Material Management
12000 Government Center Parkway, Suite 427
Fairfax, VA 22035-0013
Website: www.fairfaxcounty.gov/procurement
Phone (703) 324-3201, TTY: 711, Fax: (703) 324-3681



County of Fairfax, Virginia

AMENDMENT

AUG 27 2018

AMENDMENT NO. 16

CONTRACT TITLE: Office Furniture and Related Services

CONTRACTOR

Haworth Inc.
One Haworth Center
Holland, MI 49423

SUPPLIER CODE

1000011672

CONTRACT NO.

4400003402

By mutual agreement, Contract 4400003402 is hereby amended to add the following product line to the contract at the discount structure indicated on the attached Haworth Service Rate Sheet:

JANUS et Cie

All other prices, discounts, terms and conditions remain the same.

Steve Pierson, CPPB
Contracts Manager

Cathy A. Muse, CPPO
Director/County Purchasing Agent

DISTRIBUTION

Department of Finance – Accounts Payable/e
Facilities Management Dept. – Bill Robinson/e
Facilities Management Dept. – Rhinda Edwards/e
U. S. Communities – Tyler McCall – tmccall@uscommunities.org

Contractor (Tim.Hodges@Haworth.com)
Contract Specialist – M. Blair
Asst. Contract Spec., Team 2

Department of Procurement & Material Management
12000 Government Center Parkway, Suite 427
Fairfax, VA 22035-0013
Website: www.fairfaxcounty.gov/dpmm
Phone (703) 324-3201, TTY: 711, Fax: (703) 324-3681

HAWORTH

**HAWORTH SERVICE RATE SHEET
US COMMUNITIES CONTRACT
Multiple Award Option**

PRODUCT	Manufacturer Discount Percent from List Price based on Quantity Purchased (or other objectively verifiable criteria)					
	Amount Purchased	Drop Ship	Inside Delivery	Basic Installation*	Expanded Installation*	Volume Discounts
JANUS et Cie Products	\$1 to \$25,000 \$25,001 or more	15% Negotiable	15% Negotiable	10% to 12% Negotiable	8% to 10% Negotiable	15% Negotiable

**HAWORTH SERVICE RATE SHEET
US COMMUNITIES CONTRACT
Committed Pricing Option**

PRODUCT	Manufacturer Discount Percent from List Price based on Quantity Purchased (or other objectively verifiable criteria)					
	Amount Purchased	Drop Ship	Inside Delivery	Basic Installation*	Expanded Installation*	Volume Discounts
JANUS et Cie Products	\$1 to \$25,000 \$25,001 or more	17% Negotiable	17% Negotiable	11% to 13% Negotiable	9% to 11% Negotiable	17% Negotiable

- Note:
- Drop Ship price includes product delivery to the site, the purchaser is responsible for unloading.
 - Inside Delivery price includes product delivered to the site and unloaded
 - Basic Installation price to include inside delivery, uncrating, assembly, installation, removal of all debris from premises, installation documents and the bill of materials per the purchaser's approved plan and specifications.
 - Expanded Service Installation price to include basic installation; field measurements surveyed, documented and coordinated; electrical and tele/data infeed locations are surveyed, documented and coordinated; attend required coordination meetings with purchaser and other contractors; and creation and implementation of punch list by project manager

- *Note:
- Haworth's list pricing includes FOB destination and unloading at dock
 - Installation pricing based on the following:
 - Performed during normal business hours 7:00 am to 5:00 pm Monday through Friday – no holidays
 - Non-union labor
 - Free and clear access to loading docks and elevators
 - Job site to be free and clear of other trades
 - Reasonable access to space
 - Where applicable, Haworth will abide by union or prevailing wage rate



County of Fairfax, Virginia

AMENDMENT

MAY 23 2010

AMENDMENT NO. 15

CONTRACT TITLE: Office Furniture and Related Services

CONTRACTOR

SUPPLIER CODE

CONTRACT NO.

Haworth Inc.
One Haworth Center
Holland, MI 49423

1000011672

4400003402

By mutual agreement, Contract 4400003402 is hereby amended to add the following product line to the contract at the discount structure indicated on the attached Haworth Service Rate Sheet:

Soji Seating

All other prices, discounts, terms and conditions remain the same.

Steve Pierson, CPPB
Contracts Manager

Cathy A. Muse, CPPO
Director/County Purchasing Agent

DISTRIBUTION

Department of Finance – Accounts Payable/e
Facilities Management Dept. – Bill Robinson/e
Facilities Management Dept. – Rhinda Edwards/e
U. S. Communities – Tyler McCall – tmccall@uscommunities.org

Contractor
Contract Specialist – G. Bright
Asst. Contract Spec., Team 2

Department of Procurement & Material Management
12000 Government Center Parkway, Suite 427
Fairfax, VA 22035-0013
Website: www.fairfaxcounty.gov/dpmm
Phone (703) 324-3201, TTY: 711, Fax: (703) 324-3681

HAWORTH

**HAWORTH SERVICE RATE SHEET
US COMMUNITIES CONTRACT
Multiple Award Option**

Manufacturer Discount Percent from List Price based on Quantity Purchased (or other objectively verifiable criteria)						
PRODUCT	Amount Purchased	Drop Ship	Inside Delivery	Basic Installation*	Expanded Installation*	Volume Discounts
Soji	\$1 to \$25,000	50%	50%	43% to 45%	40% to 45%	50%
Seating	\$25,001 or more	Negotiable	Negotiable	Negotiable	Negotiable	Negotiable

**HAWORTH SERVICE RATE SHEET
US COMMUNITIES CONTRACT
Committed Pricing Option**

Manufacturer Discount Percent from List Price based on Quantity Purchased (or other objectively verifiable criteria)						
PRODUCT	Amount Purchased	Drop Ship	Inside Delivery	Basic Installation*	Expanded Installation*	Volume Discounts
Soji	\$1 to \$25,000	52%	52%	46% to 48%	42% to 48%	52%
Seating	\$25,001 or more	Negotiable	Negotiable	Negotiable	Negotiable	Negotiable

- Note:
- Drop Ship price includes product delivery to the site, the purchaser is responsible for unloading.
 - Inside Delivery price includes product delivered to the site and unloaded.
 - Basic Installation price to include inside delivery, uncrating, assembly, installation, removal of all debris from premises, installation documents and the bill of materials per the purchaser's approved plan and specifications.
 - Expanded Service Installation price to include basic installation; field measurements surveyed, documented and coordinated; electrical and tele/data infeed locations are surveyed, documented and coordinated; attend required coordination meetings with purchaser and other contractors; and creation and implementation of punch list by project manager

- *Note:
- Haworth's list pricing includes FOB destination and unloading at dock.
 - Installation pricing based on the following:
 - Performed during normal business hours 7:00 am to 5:00 pm Monday through Friday – no holidays
 - Non-union labor
 - Free and clear access to loading docks and elevators
 - Job site to be free and clear of other trades
 - Reasonable access to space
 - Where applicable, Haworth will abide by union or prevailing wage rate



County of Fairfax, Virginia

AMENDMENT

MAR 08 2018

AMENDMENT NO. 14

CONTRACT TITLE: Office Furniture and Related Services

CONTRACTOR

Haworth Inc.
One Haworth Center
Holland, MI 49423

SUPPLIER CODE

1000011672

CONTRACT NO.

4400003402

By mutual agreement contract 4400003402 is amended as indicated below effective April 1, 2018.

1. PRICE ADJUSTMENT/INCREASE

The purpose of this amendment is to notify all users that Haworth Inc. is implementing a price list adjustment effective April 1, 2018. While some prices are not changing, the overall average increase on the price list will be 3.22%.

All other prices, discounts, terms and conditions remain the same.

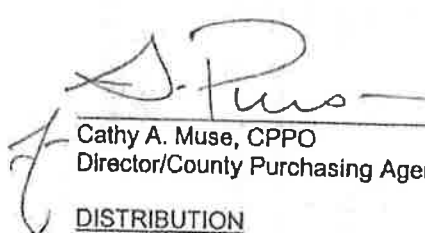
Cathy A. Muse, CPPO
Director/County Purchasing Agent

Steve Pierson, CPPB
Contracts Manager

DISTRIBUTION

Department of Finance – Accounts Payable/e
Facilities Management Dept. – Bill Robinson/e
Facilities Management Dept. – Rhinda Edwards/e
U. S. Communities – Tyler McCall – tmccall@uscommunities.org

Contractor (Cyndi.kamps@haworth.com)
Contract Specialist – G. Bright
Asst. Contract Spec., Team 2

Department of Procurement & Material Management
12000 Government Center Parkway, Suite 427
Fairfax, VA 22035-0013
Website: www.fairfaxcounty.gov/procurement
Phone (703) 324-3201, TTY: 711, Fax: (703) 324-3681



County of Fairfax, Virginia

AMENDMENT

FEB 27 2018

AMENDMENT NO. 13

CONTRACT TITLE: Office Furniture and Related Services

CONTRACTOR

SUPPLIER CODE

CONTRACT NO.

Haworth Inc.
One Haworth Center
Holland, MI 49423

1000011672

4400003402

By mutual agreement contract 4400003402 is amended to add rental services to the contract effective March 1, 2018. Pricing is attached.

All other prices, discounts, terms and conditions remain the same.

Steve Pierson, CPPB
Contracts Manager

Cathy A. Muse, CPPO
Director/County Purchasing Agent
DISTRIBUTION

Department of Finance – Accounts Payable/e
Facilities Management Dept. – Bill Robinson/e
Facilities Management Dept. – Rhinda Edwards/e
Facilities Management Dept. – Christine Covey/e
U. S. Communities – Tyler McCall – tmccall@uscommunities.org

Contractor Cyndi.kamps@haworth.com
Contract Specialist – G. Bright
Asst. Contract Spec., Team 2



County of Fairfax, Virginia

AMENDMENT

AMENDMENT NO. 12

CONTRACT TITLE: Office Furniture and Related Services

AUG 07 2017

CONTRACTOR
Haworth, Inc.
One Haworth Center.
Holland, MI 49423

SUPPLIER CODE
1000011672

CONTRACT NO.
4400003402

By mutual agreement, Contract 4400003402 is renewed for three (3) years at existing prices, discounts, terms, and conditions, effective January 1, 2018, through December 31, 2020. There are no more renewal options remaining on this contract.

ACCEPTANCE:

BY: 
(Signature)

Director Sales Support
(Title)

Phil Todd
(Printed)

August 4, 2017
(Date)

 **Steve Pierson, CPPB**
Contracts Manager
Cathy A. Muse, CPPO
Director/County Purchasing Agent

DISTRIBUTION

Department of Finance – Accounts Payable
Facilities Management Dept. – Bill Robinson/e
Facilities Management Dept. – Cathy Spaine/e
Facilities Management Dept. – Rhinda Edwards/e
Facilities Management Dept. – Christine Covey/e
U. S. Communities – Tyler McCall- tmccall@uscommunities.org
Contractor- cyndi.kamps@haworth.com

Contract Specialist – G. Bright
Asst. Contract Specialist - Team 2

Department of Procurement & Material Management
12000 Government Center Parkway, Suite 427
Fairfax, VA 22035-0013
Website: www.fairfaxcounty.gov/dpmm
Phone 703-324-3201, TTY: 711, Fax: 703-324-3228



County of Fairfax, Virginia

AMENDMENT

JUL 12 2017

AMENDMENT NO. 11

CONTRACT TITLE: Office Furniture and Related Services

CONTRACTOR

Haworth Inc.
One Haworth Center
Holland, MI 49423

SUPPLIER CODE

1000011672

CONTRACT NO.

4400003402

By mutual agreement, Contract 4400003402 is hereby amended to add the following product line to the contract at the discount structure indicated on the attached Haworth Service Rate Sheets:

Ergotron Products

All other prices, discounts, terms and conditions remain the same.

Steve Pierson, CPPB
Contracts Manager

Cathy A. Muse, CPPO
Director/County Purchasing Agent

DISTRIBUTION

Department of Finance – Accounts Payable/e
Facilities Management Dept. – Bill Robinson/e
Facilities Management Dept. – Cathy Spaine/e
Facilities Management Dept. – Rhinda Edwards/e
U. S. Communities – Tyler McCall – tmccall@uscommunities.org

Contractor
Contract Specialist – G. Bright
Asst. Contract Spec., Team 2

HAWORTH

HAWORTH SERVICE RATE SHEET
US COMMUNITIES CONTRACT 4400003402
Multiple Award Option

Manufacturer Discount Percent from List Price based on Quantity Purchased (or other objectively verifiable criteria)						
PRODUCT	Quantity Purchased	Drop Ship	Inside Delivery	Basic Installation*	Expanded Installation*	Volume Discounts
Ergotron Products	1 to 299	47.50%	47.50%	43% to 45%	40% to 45%	47.50%
	300 or more	Negotiable	Negotiable	Negotiable	Negotiable	Negotiable

HAWORTH SERVICE RATE SHEET
US COMMUNITIES CONTRACT 4400003402
Sole Award Option

Manufacturer Discount Percent from List Price based on Quantity Purchased (or other objectively verifiable criteria)						
PRODUCT	Quantity Purchased	Drop Ship	Inside Delivery	Basic Installation*	Expanded Installation*	Volume Discounts
Ergotron Products	1 to 299	50%	50%	46% to 48%	42% to 48%	50%
	300 or more	Negotiable	Negotiable	Negotiable	Negotiable	Negotiable

- Note:
- Drop Ship price includes product delivery to the site, the purchaser is responsible for unloading.
 - Inside Delivery price includes product delivered to the site and unloaded.
 - Basic Installation price to include inside delivery, uncrating, assembly, installation, removal of all debris from premises, installation documents and the bill of materials per the purchaser's approved plan and specifications.
 - Expanded Service: Installation price to include basic installation; field measurements surveyed, documented and coordinated; electrical and tele/data infeced locations are surveyed, documented and coordinated; attend required coordination meetings with purchaser and other contractors; and creation and implementation of punch list by project manager

- **Note:
- Haworth's list pricing includes FOB destination and unloading at dock.
 - Installation pricing based on the following:
 - Performed during normal business hours 7:00 am to 5:00 pm Monday through Friday – no holidays
 - Non-union labor
 - Free and clear access to loading docks and elevators
 - Job site to be free and clear of other trades
 - Reasonable access to Space
 - Where applicable, Haworth will abide by union or prevailing wage rate



County of Fairfax, Virginia

AMENDMENT

MAY 19

AMENDMENT NO. 10

CONTRACT TITLE: Office Furniture and Related Services

CONTRACTOR

SUPPLIER CODE

CONTRACT NO

Haworth Inc.
One Haworth Center
Holland, MI 49423

1000011672

4400003402

By mutual agreement contract 4400003402 is amended to allow a 2.11% price increase for the Wood Casegood Collection effective July 1, 2017.

All other prices, discounts, terms and conditions remain the same.

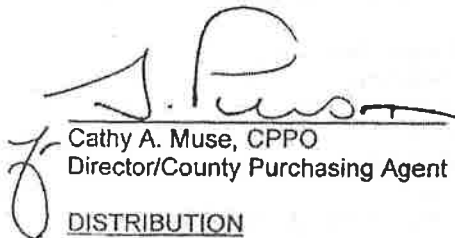
Cathy A. Muse, CPPO
Director/County Purchasing Agent

Steve Pierson, CPPB
Contracts Manager

DISTRIBUTION

Department of Finance – Accounts Payable/e
Facilities Management Dept. – Bill Robinson/e
Facilities Management Dept. – Cathy Spaine/e
Facilities Management Dept. – Rhinda Edwards/e
U. S. Communities – Tyler McCall – tmccall@uscommunities.org

Contractor (Cyndi.kamps@haworth.com)
Contract Specialist – G. Bright
Asst. Contract Spec., Team 2

Department of Procurement & Material Management
12000 Government Center Parkway
Fairfax, VA 22031

Website: www.fairfaxcounty.gov

Phone (703) 324-3201, TTY: 1-800- 828-1140, Fax: (703) 324-3202



County of Fairfax, Virginia

AMENDMENT

AMENDMENT NO. 9

MAR 07 2017

CONTRACT TITLE: Office Furniture and Related Services

CONTRACTOR

Haworth Inc.
One Haworth Center
Holland, MI 49423

SUPPLIER CODE

1000011672

CONTRACT NO.

4400003402

By mutual agreement contract 4400003402 is amended to allow a 2.11% price increase for the product lines listed below effective March 15, 2017.

Product Line

950 Fls, Pics Fs Stl, IF Lat Fls & Psts
Active Storage
Beside
Enclose First Tier
Floor Bases
Haworth Collection - Poltrona Frau
Improv, Comforto
Kinetics, Tempo, Tactics, Planes, Cmpose
Lively
Orlando LS
Patterns
Places Systems (Wood)
Premise & X-Series Files
Race
Technology Products
Unigroup Too Panels
Very Seating Line (Non-Task)
V-Series Files & Peds
X99 Seating

Accolade/Comf 28 NW/Monaco/Sys 58
Adaptable Comps-Wksr, Up Stor, Lghtng
Compose
Enclose Second Tier
Haworth Collection
Healthcare
Jump Stuff
Cassis, WD Seating
Look (Sit 10)
Orln, Trpl, Ent, Prfl, Srs K, York, Mstr
Places Systems (NW & WT)
Power Base AI
Premise Systems
TecCrete Flooring
Unigroup Systems (NW & WT)
Vancouver (Freestanding)
Very Task Seating
Wood Stg - Comp, Frnze, Glrie, Tally, Etc.
X-Series Peds 4.00%

ACCEPTANCE:

BY:

(Signature)

Phil Todd

Director Sales Support

(Title)

March 6, 2017

Department of Purchasing & Supply Management

12000 Government Center Parkway, Suite 427

Fairfax, VA 22035-0013

Website: www.fairfaxcounty.gov/dpsm

Phone (703) 324-3201, TTY: 1-800- 828-1140, Fax: (703) 324-3681

Amendment No. 9
4400003402
Page 2

All other prices, discounts, terms and conditions remain the same.



Cathy A. Muse, CPPO
Director/County Purchasing Agent

Steve Pierson, CPPB
Contracts Manager

DISTRIBUTION

Department of Finance – Accounts Payable/e
Facilities Management Dept. – Bill Robinson/e
Facilities Management Dept. – Cathy Spaine/e
Facilities Management Dept. – Rhinda Edwards/e
U. S. Communities – Tyler McCall – tmccall@uscommunities.org

Contractor (Cyndi.kamps@haworth.com)
Contract Specialist – G. Bright
Asst. Contract Spec., Team 2



County of Fairfax, Virginia

AMENDMENT

SEP 09 2016

AMENDMENT NO. 8

CONTRACT TITLE: Office Furniture and Related Services

CONTRACTOR
Haworth, Inc.
One Haworth Center.
Holland, MI 49423

SUPPLIER CODE
1000011672

CONTRACT NO.
4400003402

By mutual agreement, Contract 4400003402 is renewed for one (1) year at existing prices, discounts, terms, and conditions, effective January 1, 2017, through December 31, 2017. This is the first of four (4) renewal options available.

ACCEPTANCE

BY: *Phil Todd*
(Signature)

Dist. Sales Support
(Title)

Phil Todd
(Printed)

9/2/16
(Date)

Cathy A. Muse
Cathy A. Muse, CPPO
Director/County Purchasing Agent

Steve Pierson, CPPB
Contracts Manager

DISTRIBUTION

- Department of Finance -- Accounts Payable
- Facilities Management Dept. -- Bill Robinson/e
- Facilities Management Dept. -- Cathy Spaine/e
- Facilities Management Dept. -- Rhinda Edwards/e
- Facilities Management Dept. -- Christine Covey/o
- U. S. Communities -- Corey Imhoff -- cimhoff@uscommunities.org

- Contractor
- Contract Specialist -- G. Bright
- Asst. Contract Specialist - Team 2

Department of Procurement & Material Management
12000 Government Center Parkway, Suite 427
Fairfax, VA 22035-0013
Website: www.fairfaxcounty.gov/dpmms
Phone 703-324-3201, TTY: 711, Fax: 703-324-3228



County of Fairfax, Virginia

AMENDMENT

AMENDMENT NO. 7

JUN 23 2016

CONTRACT TITLE: Office Furniture and Related Services

CONTRACTOR

SUPPLIER CODE

CONTRACT NO.

Haworth Inc.
One Haworth Center
Holland, MI 49423

1000011672

4400003402

By mutual agreement, Contract 4400003402 is hereby amended to add the following product lines to the contract at the discount structure indicated on the attached Haworth Service Rate Sheets:

Workware
Bluescape
Fern Seating
Everyday Office

All other prices, discounts, terms and conditions remain the same.

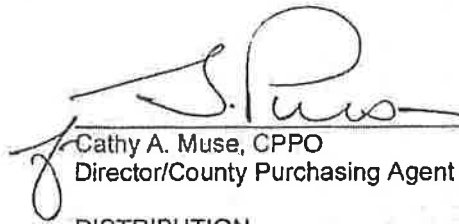

Cathy A. Muse, CPPO
Director/County Purchasing Agent

Steve Pierson, CPPB
Contracts Manager

DISTRIBUTION

Department of Finance – Accounts Payable/e
Facilities Management Dept. – Bill Robinson/e
Facilities Management Dept. – Cathy Spaine/e
Facilities Management Dept. – Rhinda Edwards/e
U. S. Communities – Tyler McCall – tmccall@uscommunities.org

Contractor
Contract Specialist – G. Bright
Asst. Contract Spec., Team 2

Department of Purchasing & Supply Management
12000 Government Center Parkway, Suite 427
Fairfax, VA 22035-0013

Website: www.fairfaxcounty.gov/dpsm

Phone (703) 324-3201, TTY: 711, Fax: (703) 324-3681

AMENDMENT 7
4400003402

**HAWORTH SERVICE RATE SHEET
US COMMUNITIES CONTRACT**

PRODUCT	Manufacturer Discount Percent from List Price (or other objectively verifiable criteria)					
	List Price	Drop Ship	Inside Delivery	Basic Installation*	Expanded Installation*	Volume Discounts
Everyday Office	\$1 to \$300,000 \$300,001 and More	50% Negotiable	50% Negotiable	45% to 47.5% Negotiable	43% to 47% Negotiable	50% Negotiable

Note: 1. Drop Ship price includes product delivery to the site, the purchaser is responsible for unloading.
 2. Inside Delivery price includes product delivered to the site and unloaded
 3. Basic Installation price to include inside delivery, uncrating, assembly, installation, removal of all debris from premises, installation documents and the bill of materials per the purchaser's approved plan and specifications.
 4. Expanded Service Installation price to include basic installation; field measurements surveyed, documented and coordinated; electrical and tele/data infeed locations are surveyed, documented and coordinated; attend required coordination meetings with purchaser and other contractors; and creation and implementation of punch list by project manager

*Note: 1. Haworth's list pricing includes FOB destination and unloading at dock.
 2. Installation pricing based on the following:
 a. Performed during normal business hours 7:00 am to 5:00 pm Monday through Friday - no holidays
 b. Non-union labor
 c. Free and clear access to loading docks and elevators
 d. Job site to be free and clear of other trades
 e. Reasonable access to Space
 f. Where applicable, Haworth will abide by union or prevailing wage rate

HAWORTH

AMENDMENT 7
4400003403

HAWORTH SERVICE RATE SHEET US COMMUNITIES CONTRACT

Manufacturer Discount Percent from List Price
(or other objectively verifiable criteria)

PRODUCT	List Price	Drop Ship	Inside Delivery	Basic Installation*	Expanded Installation*	Volume Discounts
Fern Seating	\$1 to \$50,000 \$50,001 and more	50%	50% Negotiable	45% to 47.5% Negotiable	43% to 47% Negotiable	50% Negotiable

Note:

- Drop Ship price includes product delivery to the site, the purchaser is responsible for unloading.
- Inside Delivery price includes product delivered to the site and unloaded
- Basic Installation price to include inside delivery, uncrating, assembly, installation, removal of all debris from premises, installation documents and the bill of materials per the purchaser's approved plan and specifications.
- Expanded Service Installation price to include basic installation; field measurements surveyed, documented and coordinated; electrical and tele/data infeed locations are surveyed, documented and coordinated; attend required coordination meetings with purchaser and other contractors; and creation and implementation of punch list by project manager

*Note:

- Haworth's list pricing includes FOB destination and unloading at dock.
- Installation pricing based on the following:
 - Performed during normal business hours 7:00 am to 5:00 pm Monday through Friday - no holidays
 - Non-union labor
 - Free and clear access to loading docks and elevators
 - Job site to be free and clear of other trades
 - Reasonable access to Space
 - Where applicable, Haworth will abide by union or prevailing wage rate

HAWORTH

AMENDMENT 7
440000 3402

HAWORTH SERVICE RATE SHEET US COMMUNITIES CONTRACT

PRODUCT	Manufacturer Discount Percent from List Price (or other objectively verifiable criteria)				Volume Discounts	
	List Price	Drop Ship	Inside Delivery	Basic Installation*		Expanded Installation*
Workware	\$1 and more	55%	55% Negotiable	Technology products are quoted by project	Technology products are quoted by project	55% Negotiable
Bluescape	\$1 and more	Bluescape products are quoted by project	Bluescape products are quoted by project	Technology products are quoted by project	Technology products are quoted by project	Bluescape products are quoted by project

Note: 1. Drop Ship price includes product delivery to the site, the purchaser is responsible for unloading.
 2. Inside Delivery price includes product delivered to the site and unloaded
 3. Basic Installation price to include inside delivery, uncrating, assembly, installation, removal of all debris from premises, installation documents and the bill of materials per the purchaser's approved plan and specifications.
 4. Expanded Service Installation price to include basic installation; field measurements surveyed, documented and coordinated; electrical and tele/data infeed locations are surveyed, documented and coordinated; attend required coordination meetings with purchaser and other contractors; and creation and implementation of punch list by project manager

*Note: 1. Haworth's list pricing includes FOB destination and unloading at dock.
 2. Installation pricing based on the following:
 a. Performed during normal business hours 7:00 am to 5:00 pm Monday through Friday - no holidays
 b. Non-union labor
 c. Free and clear access to loading docks and elevators
 d. Job site to be free and clear of other trades
 e. Reasonable access to Space
 f. Where applicable, Haworth will abide by union or prevailing wage rate



County of Fairfax, Virginia

AMENDMENT

APR 27 2016

AMENDMENT NO. 6

CONTRACT TITLE: Office Furniture and Related Services

CONTRACTOR

SUPPLIER CODE

CONTRACT NO.

Haworth Inc.
One Haworth Center
Holland, MI 49423

1000011672

4400003402

By mutual agreement contract 4400003402 is amended as indicated below effective May 1, 2016.

ADD SUITE CASEGOODS:

Product	List Price	Drop Ship	Inside Delivery	Basic Installation	Expanded Installation	Volume Discount
Suite Wood Casegoods	\$1 to \$25,000 \$25,001 & more	53% Negotiable	48% to 50.5% Negotiable	48% to 50.5% Negotiable	46% to 50% Negotiable	53% Negotiable
A Series Storage	\$1 to \$25,000 \$25,001 & more	53% Negotiable	48% to 50.5% Negotiable	48% to 50.5% Negotiable	46% to 50% Negotiable	53% Negotiable
Intuity Benching	\$1 to \$25,000 \$25,001 & more	53% Negotiable	48% to 50.5% Negotiable	48% to 50.5% Negotiable	46% to 50% Negotiable	53% Negotiable

All other prices, discounts, terms and conditions remain the same.

Cathy A. Muse, CPPO
Director/County Purchasing Agent

Steve Pierson, CPPB
Contracts Manager

DISTRIBUTION

Department of Finance – Accounts Payable/e
Facilities Management Dept. – Bill Robinson/e
Facilities Management Dept. – Cathy Spaine/e
Facilities Management Dept. – Rhinda Edwards/e
U. S. Communities – Tyler McCall – tmccall@uscommunities.org

Contractor
Contract Specialist – G. Bright
Asst. Contract Spec., Team 2

Department of Purchasing & Supply Management
12000 Government Center Parkway, Suite 427
Fairfax, VA 22035-0013

Website: www.fairfaxcounty.gov/dpsm

Phone (703) 324-3201, TTY: 1-800- 828-1140, Fax: (703) 324-3681



County of Fairfax, Virginia

AMENDMENT

DEC 21 2015

AMENDMENT NO. 5

CONTRACT TITLE: Office Furniture and Related Services

CONTRACTOR

SUPPLIER CODE

CONTRACT NO.

Haworth Inc.
One Haworth Center
Holland, MI 49423

1000011672

4400003402

By mutual agreement contract 4400003402 is amended as indicated below effective immediately.

REVISED DISCOUNT SCHEDULE:

Product Group	List Volume	Customer Discount
Haworth Health Environments (HHE)	\$1 - \$55,555	51%
	\$55,556 to \$150,000	52%
	\$150,001 to \$500,000	53%
	\$500,001 to \$1,000,000	54%
	\$1,000,001 to \$9,999,999	55%

All other prices, discounts, terms and conditions remain the same.

Cathy A. Muse, CPPO
Director/County Purchasing Agent

Steve Pierson, CPPB, VCO
Contracts Manager

DISTRIBUTION

Department of Finance – Accounts Payable/e
Facilities Management Dept. – Bill Robinson/e
Facilities Management Dept. – Cathy Spaine/e
Facilities Management Dept. – Rhinda Edwards/e

Contractor
Contract Specialist – G. Bright
Asst. Contract Spec., Team 2

U. S. Communities – Tyler McCall – tmccall@uscommunities.org

Department of Purchasing & Supply Management
12000 Government Center Parkway, Suite 427
Fairfax, VA 22035-0013

Website: www.fairfaxcounty.gov/dpsm
Phone (703) 324-3201, TTY: 1-800- 828-1140, Fax: (703) 324-3681



County of Fairfax, Virginia

AMENDMENT

JUN 09 2015

AMENDMENT NO. 4

CONTRACT TITLE: Office Furniture and Related Services

<u>CONTRACTOR</u>	<u>SUPPLIER CODE</u>	<u>CONTRACT NO.</u>
Haworth Inc. One Haworth Center Holland, MI 49423	1000011672	4400003402

The purpose of this amendment is to notify all users that Haworth Inc. is implementing a price list adjustment of 3.19%, effective June 1, 2015.

All other discounts, terms and conditions remain the same.

Cathy A. Muse, CPPO
Director/County Purchasing Agent

Steve Pierson, CPPB, VCO
Contracts Manager

DISTRIBUTION

Department of Finance – Accounts Payable/e
Facilities Management Dept. – Bill Robinson/e
Facilities Management Dept. – Cathy Spaine/e
Facilities Management Dept. – Rhinda Edwards/e

Contractor
Contract Specialist – G. Bright
Asst. Contract Spec., Team 2

U. S. Communities – Corey Imhoff – cimoff@uscommunities.org

Department of Purchasing & Supply Management

12000 Government Center Parkway, Suite 427
Fairfax, VA 22035-0013

Website: www.fairfaxcounty.gov/dpsm

Phone (703) 324-3201, TTY: 1-800- 828-1140, Fax: (703) 324-3681



County of Fairfax, Virginia

AMENDMENT

AMENDMENT NO. 3

JUN 20 2013

CONTRACT TITLE: Office Furniture and Related Services

CONTRACTOR

SUPPLIER CODE

CONTRACT NO.

Haworth Inc.
One Haworth Center
Holland, MI 49423

1000011672

4400003402

By mutual agreement contract 4400003402 is amended as follows effective immediately.

1. ADD: Poltrona Frau products. This product is not available for purchase by Fairfax County Government departments and Fairfax County Public Schools. It is being added only for the use by other public agencies. The discount pricing is as follows:

Product Line	Discount
Poltrona Frau - \$1 and above	15% off list

2. REMOVE: Life Space wall products.

All other prices, discounts, terms and conditions remain the same.

Cathy A. Muse, CPPO
Director/County Purchasing Agent

DISTRIBUTION

Department of Finance – Accounts Payable/e
Facilities Management Dept. – Bill Robinson/e
Facilities Management Dept. – Cathy Spaine/e
Facilities Management Dept. – Rhinda Edwards/e
Facilities Management Dept. – Christine Covey/e

Contractor
Contract Specialist – G. Bright
Asst. Contract Spec., Team 2

U. S. Communities – Corey Imhoff – cimoff@uscommunities.org

Department of Purchasing & Supply Management
12000 Government Center Parkway, Suite 427
Fairfax, VA 22035-0013

Website: www.fairfaxcounty.gov/dpsm

Phone (703) 324-3201, TTY: 1-800- 828-1140, Fax: (703) 324-3681



County of Fairfax, Virginia

AMENDMENT

AMENDMENT NO. 2

=

JUN 11 2013

CONTRACT TITLE: Office Furniture and Related Services

CONTRACTOR

SUPPLIER CODE

CONTRACT NO.

Haworth Inc.
One Haworth Center
Holland, MI 49423

1000011672

4400003402

By mutual agreement contract 4400003402 is amended to add Tuohy Product Line to the contract effective immediately. The discount pricing for this product line is attached.

All other prices, discounts, terms and conditions remain the same.

Cathy A. Muse, CPPO
Director/County Purchasing Agent

DISTRIBUTION

Department of Finance – Accounts Payable/e
Facilities Management Dept. – Bill Robinson/e
Facilities Management Dept. – Cathy Spalne/e
Facilities Management Dept. – Rhinda Edwards/e

Contractor
Contract Specialist – G. Bright
Asst. Contract Spec., Team 2

U. S. Communities – Corey Imhoff – cimoff@uscommunities.org

Department of Purchasing & Supply Management
12000 Government Center Parkway, Suite 427
Fairfax, VA 22035-0013

Website: www.fairfaxcounty.gov/dpsm

Phone (703) 324-3201, TTY: 1-800- 828-1140, Fax: (703) 324-3681

Amendment No. 2
 Contract 4400003402
 Attachment 1

HAWORTH, INC. - U.S. COMMUNITIES
 TUOHY PRODUCT LINE DISCOUNT

Discounts taken from price list in effect at time of order
 See following page for delivery zone details

Product Group	Shipping Zone	List Value	Customer Discount
Executive Office Furniture, Executive Conference Room Furniture, Tables and Accessories	Zone 1	\$1 - \$25,000	45%
		\$25,001 - \$75,000	46%
		\$75,001 - \$200,000	47%
		\$200,001 - \$300,000	48%
		\$300,001 - \$400,000	49%
		\$400,001 - \$ 500,000	50%
	Zone 2	\$1 - \$25,000	46.2%
		\$25,001 - \$75,000	47.2%
		\$75,001 - \$200,000	48.2%
		\$200,001 - \$300,000	49.2%
		\$300,001 - \$400,000	50.2%
		\$400,001 - \$ 500,000	51.2%
	Zone 3	\$1 - \$25,000	45.6%
		\$25,001 - \$75,000	46.6%
		\$75,001 - \$200,000	47.6%
		\$200,001 - \$300,000	48.6%
		\$300,001 - \$400,000	49.6%
		\$400,001 - \$ 500,000	50.6%
Upholstered Seating	Zone 1	\$1 - \$25,000	45%
		\$25,001 - \$75,000	46%
		\$75,001 - \$200,000	47%
		\$200,001 - \$300,000	48%
	Zone 2	\$1 - \$25,000	46.2%
		\$25,001 - \$75,000	47.2%
		\$75,001 - \$200,000	48.2%
		\$200,001 - \$300,000	49.2%
	Zone 3	\$1 - \$25,000	45.6%
		\$25,001 - \$75,000	46.6%
		\$75,001 - \$200,000	47.6%
		\$200,001 - \$300,000	48.6%
Multiple Seating, Stacking Chairs	Zone 1	\$1 - \$25,000	45%
		\$25,001 - \$75,000	46%
		\$75,001 - \$200,000	47%
	Zone 2	\$1 - \$25,000	46.2%
		\$25,001 - \$75,000	47.2%
		\$75,001 - \$200,000	48.2%
	Zone 3	\$1 - \$25,000	45.6%
		\$25,001 - \$75,000	46.6%
		\$75,001 - \$200,000	47.6%



County of Fairfax, Virginia

AMENDMENT

AMENDMENT NO. 1

MAR 19 2013

CONTRACT TITLE: Office Furniture and Related Services

CONTRACTOR

SUPPLIER CODE

CONTRACT NO.

Haworth Inc.
One Haworth Center
Holland, MI 49423

1000011672

4400003402

By mutual agreement contract 4400003402 is amended to add Groupe Lacasse products to the contract effective immediately. The discount pricing for this product is attached.

All other prices, discounts, terms and conditions remain the same.

Cathy A. Muse

Cathy A. Muse, CPPO
Director/County Purchasing Agent

DISTRIBUTION

Department of Finance – Accounts Payable/e
Facilities Management Dept. – Bill Robinson/e
Facilities Management Dept. – Cathy Spaine/e
Facilities Management Dept. – Rhinda Edwards/e

Contractor
Contract Specialist – G. Bright
Asst. Contract Spec., Team 2

U. S. Communities – Corey Imhoff – cimoff@uscommunities.org

Department of Purchasing & Supply Management
12000 Government Center Parkway, Suite 427
Fairfax, VA 22035-0013
Website: www.fairfaxcounty.gov/dpsm
Phone (703) 324-3201, TTY: 1-800-828-1140, Fax: (703) 324-3681

Amendment No. 1
 CONTRACT # 4400003402
 Attachment 1

HAWORTH INC.
 U.S. COMMUNITIES
GROUPE LACASSE PRODUCT DISCOUNT

Product Group	List Value	Customer Discount
Nvision	\$0 - \$50,000	50%
	\$50,001 - \$200,000	55%
	Above \$200,001	Negotiable
United Chair - Affinity, Brylee, Fortune, Freestyle, Onyx, Radar, S Series, Stools, VT, Zing, 90's, 4800, 7700	\$0 - \$50,000	50%
	\$50,001 - \$200,000	55%
	Above \$200,001	Negotiable
Lacasse - Concept 3, 300, 400E, 70, C.I.T.E., Electricom II, Morpheo, Nex, Options, Pangram, Quad, Quorum, Lateral files & storage, ThinkSmart Educational and Accessories	\$0 - \$50,000	50%
	\$50,001 - \$200,000	55%
	Above \$200,001	Neogitable

To access Groupe Lacasse production information go to www.grounelacasse.com and click on "Price Books". There is no login required to access this information.

Department of Purchasing & Supply Management
 12000 Government Center Parkway, Suite 427
 Fairfax, VA 22035-0013
 Website: www.fairfaxcounty.gov/dpsm
 Phone (703) 324-3201, TTY: 1-800- 828-1140, Fax: (703) 324-3681

Attachment "C"

MOCK-UP

Products
Benefits
Research + Knowledge
Sustainability
Envision Your Space
Pricing
FAQs

How do I place an order with Haworth?

Haworth’s extensive network of certified dealers will design, order, and install products throughout North America. For product specification, pricing, and services, you may contact us by:

- Email: uscommunities@haworth.com or call 800-576-0943 to place your order
- Your request will be forwarded to Haworth’s local field sales person and/or dealer within 24 hours

What products and services are provided under Haworth’s U.S. Communities contract?

All of them. In addition to products, our services such as design, installation, and project management are now included as a dollar amount rather than a percentage. This provides ease of calculation in estimating the service costs required to successfully complete your project.

How do I find a local Haworth dealer?

You can find your local Haworth dealer by using our dealer locator. Certified Haworth dealers are certified to represent Haworth’s complete offering of interior solutions.

UX SOURCE

What are Haworth’s pricing options?

Haworth is the only furniture supplier on contract with two pricing options – multiple

award and sole source discounting. Our multiple award discounts offer competitive pricing to the agency that would like to purchase Haworth products as well as keep the option to purchase from other furniture suppliers. For those agencies that commit to purchasing all of their interior solutions from Haworth, we offer our sole source discount structure. Your commitment to purchase Haworth's complete offering of interior solutions provides a more economical purchasing solution.

What is the discount advantage of sole source pricing?

There is approximately a 2% advantage in discounts off list for sole source pricing. To purchase using Haworth's sole source discounts, a signed Haworth participation form is required. This indicates you agree to purchase all of your interiors solutions products from Haworth.

What are Haworth's shipping terms?

Haworth's shipping terms are CPT (Carriage Paid To) for the continental U.S. and Canada, and CIF (cost of insurance and freight) for Alaska, Hawaii, and Puerto Rico.



Attachment "D"

MOCK-UP

WELCOME TO SIMPLE™

SERVICES (HTTPS://WWW.UNISOURCEIT.COM/SERVICES/)

PRODUCTS (HTTPS://WWW.UNISOURCEIT.COM/PRODUCTS/)

WORK (HTTPS://WWW.UNISOURCEIT.COM/WORK/)

ABOUT (HTTPS://WWW.UNISOURCEIT.COM/ABOUT/)

BLOG (HTTP://BLOG.UNISOURCEIT.COM)

CONTACT (HTTPS://WWW.UNISOURCEIT.COM/CONTACT/)

UNISOURCE - "preferred dealer" as per

HAWORTH'S / U.S. Communities
FAQ'S

"Dealer Locator" tool.

Services

see installation below

[SERVICES OVERVIEW \(HTTPS://WWW.UNISOURCEIT.COM/SERVICES/\)](https://www.unisourceit.com/services/) | [WORKPLACE STRATEGY \(HTTPS://WWW.UNISOURCEIT.COM/SERVICES/WORKPLACE-STRATEGY/\)](https://www.unisourceit.com/services/workplace-strategy/)
| [WORKSPACE PLANNING AND SOURCING \(HTTPS://WWW.UNISOURCEIT.COM/SERVICES/WORKSPACE-PLANNING-AND-SOURCING/\)](https://www.unisourceit.com/services/workspace-planning-and-sourcing/) | [LOGISTICS AND INVENTORY AND FACILITIES MANAGEMENT \(HTTPS://WWW.UNISOURCEIT.COM/SERVICES/LOGISTICS-AND-FACILITIES-MANAGEMENT/\)](https://www.unisourceit.com/services/logistics-and-facilities-management/)

Workspace Planning and Sourcing

Our talented team of designers partner with you to realize your workplace vision. From project concept to design development and complete documentation, we offer solutions to right-size your space, furnish it with new or existing product, and create environments that foster collaboration and power productivity. Welcome to workspace planning and sourcing services made simple.

Space Planning and Design:

Our objective is to maximize the performance of your new or existing office space. Our team will get to know your needs, review existing conditions and develop an effective and efficient space plan. We'll provide material, fabric, and color samples to determine the right choices for your new workspace.

Visualization Tools:

Our Visualization Studio offers photo realistic architectural renderings and animations of your project. The opportunity to preview different materials, fabrics and colors gives our designers the flexibility and freedom to mix and match in order to determine the right choices for your new workspace—well before you move in.

Project Management:

Our success is largely due to our ability to manage the projects we perform. Our experienced project managers ensure the successful execution of each phase of the furniture project, from the initial needs analysis, through design, installation and final punch list.

Contract Furniture:

We have the best in class furniture and rep major manufacturers including: Haworth, Allsteel, Herman Miller, Kimball, Knoll, Steelcase, Teknion. With our large dealer network we can help meet your furnishing needs and source and install product reflective of your brand.

Ergonomics & Wellness:

Proper ergonomics ensures happier and healthier employees. We provide consulting for program development, risk assessment, workplace design, furniture and technology solutions, as well as training to empower your team for

Systems Installation:

We employ 120+ installers throughout California. Our in-depth knowledge of the major manufacturers and quality support for every installation at a cost benefit.

Sign up for email updates

If you love space planning and office furniture and want to know the ins and outs of workplace design and facilities management, subscribe to our email and stay informed.

See More Services:

Subscribe now

- [WORKPLACE STRATEGY \(https://www.unisourceit.com/services/workplace-strategy/\)](https://www.unisourceit.com/services/workplace-strategy/)

- [LOGISTICS AND INVENTORY AND FACILITIES MANAGEMENT \(https://www.unisourceit.com/services/logistics-and-facilities-management/\)](https://www.unisourceit.com/services/logistics-and-facilities-management/)

For a complete outline of our workspace planning and sourcing services and all of our workspace strategy and services, download our brochure.

DOWNLOAD OUR SERVICES BROCHURE » (https://info.unisourceit.com/cs/c/?cla_guid=1a806213-c153-427d-86e8-61e6c42df937&pl_sourcing%2F&redirect_url=APefjpHtIL13ZcwuYaf3xs40F-cHHQ-IrTRUjEFGuynedCM3NwIROTReX0vWC9pONEfz:lQmXQumHVJzbrN5FdCWax3xkWcZk2y-ZFqPihw3laDeQcPkI1rrvNdzub3GoB7D9q332b840f501e&hsutk=1799b710cd19764f8c31182b9611e262&utm_referrer=https%3A%2F%2Fwww.unisourceit.com%2Fservices%2F&__)



Let's Get Started

Schedule a custom consultation and let's discuss how we can help you achieve your goals.

REQUEST MY CUSTOM CONSULTATION » ([HTTP://INFO.UNISOURCEIT.COM/GET-STARTED-WITH-UNISOURCE-SOLUTIONS-FOR-OFFICE-FURNITURE-SOLUTIONS](http://info.unisourceit.com/get-started-with-unisource-solutions-for-office-furniture-solutions))

Website

- Home (<https://www.unisourceit.com/>)
- Services (<https://www.unisourceit.com/services/>)
- Products (<https://www.unisourceit.com/products/>)
- Work (<https://www.unisourceit.com/work/>)
- About (<https://www.unisourceit.com/about/>)
- Blog (<http://blog.unisourceit.com>)
- Contact (<https://www.unisourceit.com/contact/>)
- Careers (<https://www.unisourceit.com/about/careers/>)

Contact

- Los Angeles HQ**
8350 Rex Road
Pico Rivera, CA 90660
(<https://maps.google.com/maps?q=8350+Rex+Road+,+Pico+Rivera,+CA+90660>) 562.949.1111 (tel:+15629491111)
- San Francisco**
31101 Wlegman Road
Hayward, CA 94545
(<https://maps.google.com/maps?q=31101+Wlegman+Road+,+Hayward,+CA+94545>) 510.475.2000 (tel:+15104752000)

Follow Us

f (<https://www.facebook.com/unisourcesolutions/>) **t** (<https://twitter.com/unisourceit>) **in** (<https://www.linkedin.com/company/unisource-solutions>) **@** (<https://www.instagram.com/unisourcesolutions/>)

(<http://haworth.com/>)

© 2019 Unisource Solutions. All rights reserved. Privacy Policy (<https://www.unisourceit.com/privacy-policy/>)

Sign up for email updates ✕

If you love space planning and office furniture and want to know the ins and outs of workplace design and facilities management, subscribe to our email and stay informed.

Subscribe now

<https://www.unisourceit.com/services/workspace-planning-and-sourcing/>

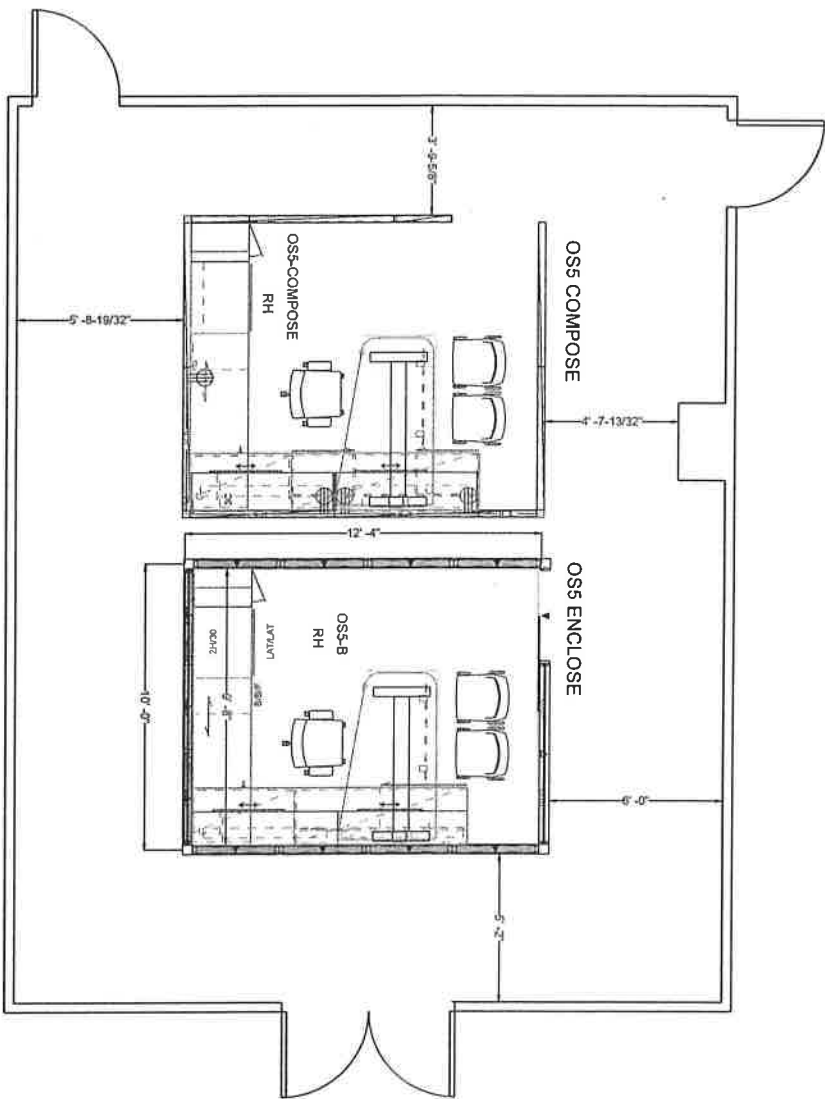

FURNITURE LAYOUT

UNISOURCE SOLUTIONS

13

GENERAL NOTES

1. See notes on previous sheets.
2. Standard and Uniflex are registered trademarks of Uniflex International, Inc. All other trademarks are the property of their respective owners.
3. All dimensions are in feet and inches unless otherwise noted.
4. All dimensions are to the center of the member unless otherwise noted.
5. All dimensions are to the face of the member unless otherwise noted.
6. All dimensions are to the center of the member unless otherwise noted.
7. All dimensions are to the face of the member unless otherwise noted.
8. All dimensions are to the center of the member unless otherwise noted.
9. All dimensions are to the face of the member unless otherwise noted.
10. All dimensions are to the center of the member unless otherwise noted.
11. All dimensions are to the face of the member unless otherwise noted.
12. All dimensions are to the center of the member unless otherwise noted.
13. All dimensions are to the face of the member unless otherwise noted.
14. All dimensions are to the center of the member unless otherwise noted.
15. All dimensions are to the face of the member unless otherwise noted.
16. All dimensions are to the center of the member unless otherwise noted.
17. All dimensions are to the face of the member unless otherwise noted.
18. All dimensions are to the center of the member unless otherwise noted.
19. All dimensions are to the face of the member unless otherwise noted.
20. All dimensions are to the center of the member unless otherwise noted.

NO.	REVISIONS
1	
2	
3	
4	
5	
6	
7	
8	
9	
10	
11	
12	
13	
14	
15	
16	
17	
18	
19	
20	

PROJECT: PORT OF LA
 OS5 MOCK UP STATION
 ENCLOSE/ EFG OFFICE

PREPARED BY: UNISOURCE SOLUTIONS
 425 S PALOS VERDES ST.
 SAN PEDRO, CA

DATE: 1/11/11	SCALE: 1/8" = 1'-0"
DRAWN BY: J. BROWN	CHECKED BY: J. BROWN
PROJECT NO: 11-001	SHEET NO: 1 OF 1
UNISOURCE SOLUTIONS 425 S PALOS VERDES ST. SAN PEDRO, CA 90731 TEL: (310) 317-1111 FAX: (310) 317-1112 WWW.UNISOURCE-SOLUTIONS.COM	

Attachment "F"

MOCK-UP

02/11/2019

HAWORTH

Assembly Name: Hgt Adj Conv Worktop - T-Leg Base - Wedge Radius
 Product Lines: Masters Series

Masters Series - Height Adjustable Convergent Worktop - T-Leg Base - Wedge Radius

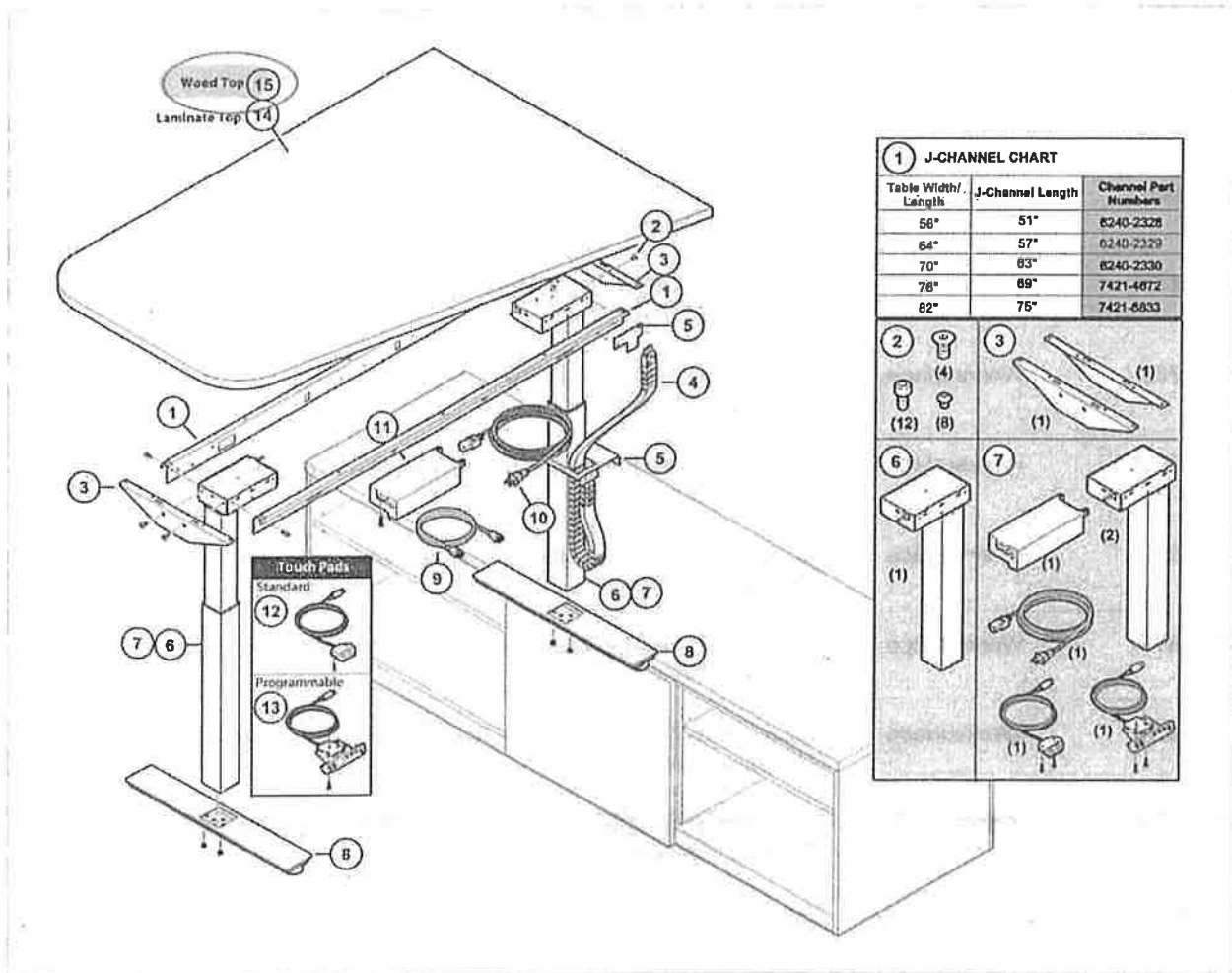

Find #	Part #	Part Name	Description
15	7471-971V	Worksurface	Convergent, Wedge Rad Top, LH, 41/29in x 58in, Wd, Sqr (1) Edge, Masters, Svc
15	7471-972V	Worksurface	Convergent, Wedge Rad Top, LH, 41/29in x 64in, Wd, Sqr (1) Edge, Masters, Svc
15	7471-973V	Worksurface	Convergent, Wedge Rad Top, LH, 41/29in x 70in, Wd, Sqr (1) Edge, Masters, Svc