

March 19, 2019

Project No. 12091-01

Mr. Tim Howard  
**Howard Industrial Partners**  
1944 North Tustin Street, Suite 122  
Tustin, California 92865

**Subject: Preliminary Geotechnical Evaluation and Response to City Review Comments for Proposed San Pedro Distribution Center, 1599 W. John S. Gibson Boulevard, Los Angeles, California**

In accordance with your request, LGC Geotechnical, Inc. has performed a geotechnical evaluation and response to City review comments for the proposed San Pedro Distribution Center, to be located at 1599 W. John S. Gibson Boulevard in Los Angeles, California. This report presents the results of our subsurface evaluation and geotechnical analysis and provides a summary of our findings, conclusions, and preliminary geotechnical recommendations relative to the proposed development of the site.

For submittal, the City of Los Angeles Department of Building and Safety requires two copies of this report including one unbound wet-signed for archiving purposes and a pdf file of the complete report on CD or flash drive.

Should have any questions regarding this report, please do not hesitate to contact our office. We appreciate this opportunity to be of service.

Respectfully submitted,

**LGC Geotechnical, Inc.**



Kevin B. Colson, CEG 2210  
Vice President



Brad Zellmer, GE 2618  
Project Engineer



CNJ/KBC/BTZ/aca

- Distribution:
- (1) Addressee (electronic copy)
  - (4) Thienes Engineering, Inc. (3 wet signed copies & pdf file on CD for agency submittal)  
Attn: Mr. Cesar Raymundo
  - (1) Reinforced Earth (electronic copy)  
Attn: Mr. Paul Frankenberger

**TABLE OF CONTENTS**

<b><u>Section</u></b>	<b><u>Page</u></b>
<b>1.0 INTRODUCTION .....</b>	<b>1</b>
1.1 Purpose and Scope of Services.....	1
1.2 Project Description and Existing Conditions .....	1
1.3 Background.....	2
1.4 Subsurface Evaluation.....	3
1.5 Laboratory Testing.....	3
<b>2.0 GEOTECHNICAL CONDITIONS.....</b>	<b>6</b>
2.1 Regional Geology .....	6
2.2 Site-Specific Geology .....	6
2.2.1 Artificial Fill – Undocumented (Map Symbol – afu).....	6
2.2.2 Artificial Fill – Older (Map Symbol – afo) .....	6
2.2.3 Topsoil/Colluvium .....	7
2.2.4 Quaternary Landslide (Map Symbol – Ols).....	7
2.2.5 Old Marine Terrace Deposits (Map Symbol – Qom) .....	7
2.3 Geologic Structure .....	7
2.4 Landslides .....	7
2.5 Groundwater.....	8
2.6 Faulting .....	8
2.6.1 Lurching and Shallow Ground Rupture .....	9
2.6.2 Liquefaction and Dynamic Settlement.....	10
2.6.3 Lateral Spreading.....	10
2.6.4 Tsunamis and Seiches .....	11
2.7 Seismicity.....	11
2.8 Slope Stability.....	13
2.9 Rippability .....	14
2.10 Oversized Material.....	14
2.11 Expansive Soil Characteristics.....	14
2.12 Corrosion Potential.....	14
<b>3.0 CONCLUSIONS .....</b>	<b>15</b>
<b>4.0 PRELIMINARY RECOMMENDATIONS .....</b>	<b>17</b>
4.1 Site Earthwork.....	17
4.1.1 Site Preparation.....	17
4.1.2 Removal Depths and Limits .....	18
4.1.3 Temporary Excavations .....	19
4.1.4 Subdrains .....	19
4.1.5 Subgrade Preparation .....	20
4.1.6 Material for Fill .....	20
4.1.7 Placement and Compaction of Fills.....	21
4.1.8 Trench and Retaining Wall Backfill and Compaction .....	22

**TABLE OF CONTENTS (Cont'd)**

4.1.9	Shrinkage and Bulking .....	23
4.2	Slope Stability.....	23
4.2.1	Existing Native Slopes .....	23
4.2.2	Fill Slopes.....	23
4.2.3	Stabilization Fill Slopes .....	23
4.2.4	Slope Maintenance Guidelines.....	24
4.3	Soldier Pile Walls .....	25
4.4	MSE Retaining Walls.....	26
4.5	Soil Bearing and Lateral Resistance .....	27
4.6	Preliminary Pavement Sections.....	28
4.7	Corrosivity to Concrete and Metal.....	29
4.8	Nonstructural Concrete Flatwork .....	30
4.9	Subsurface Water Infiltration .....	30
4.10	CIDH Pile Construction.....	31
4.11	Pre-Construction Monitoring.....	32
4.12	Geotechnical Plan Review .....	32
4.13	Geotechnical Observation and Testing During Construction.....	32
<b>5.0</b>	<b>RESPONSE TO CITY REVIEW COMMENTS.....</b>	<b>33</b>
<b>6.0</b>	<b>LIMITATIONS.....</b>	<b>38</b>

**TABLE OF CONTENTS (Cont'd)**

**List of Illustrations, Tables, and Appendices**

**Figures**

Figure 1 – Site Location Map (Page 5)

**Tables**

Table 1 – Seismic Design Parameters (Page 12)

Table 2 – Soil Shear Strength Parameters (Page 13)

Table 3A – Lateral Earth Pressures for Soldier Pile Walls (Page 25)

Table 3B – Seismic Lateral Earth Pressure Increment (Page 26)

Table 4 – Soil Shear Strength Parameters for MSE Walls (Page 27)

Table 5 – Asphalt Concrete Paving Section Options (Page 29)

Table 6 – Nonstructural Concrete Flatwork (Page 30)

**Sheets**

Sheets 1 through 3 – Geotechnical Map (In Pocket)

Sheet 4 – Geotechnical Cross Sections A-A' through E-E' (In Pocket)

Sheet 5 – Geotechnical Cross Sections F-F' through I-I' (In Pocket)

**Appendices**

Appendix A – References

Appendix B – Boring & CPT Logs

Appendix C – Laboratory Test Results

Appendix D – Slope Stability and Engineering Analyses

Appendix E – General Earthwork and Grading Specifications for Rough Grading

Appendix F – City of Los Angeles Review Sheet dated March 30, 2018



## **1.0 INTRODUCTION**

### **1.1 Purpose and Scope of Services**

This report presents the results of our preliminary geotechnical evaluation and response to City review comments for the development of the proposed San Pedro Distribution Center to be located at 1599 W. John S. Gibson Boulevard in Los Angeles, California (see Site Location Map, Figure 1). The purpose of our study was to evaluate the existing onsite geotechnical conditions in regard to the proposed site improvements. This report presents the results of our subsurface evaluation and geotechnical analysis and provides a summary of our findings, conclusions, and preliminary geotechnical recommendations relative to the proposed development of the site.

Our scope of services included:

- Review of pertinent geotechnical reports, aerial photographs, and geologic maps (Appendix A);
- Geologic mapping of the site;
- Excavation, sampling, and downhole logging of six large-diameter borings. Logs of the borings are presented in Appendix B and their approximate locations are depicted on the Geotechnical Map, Sheets 1 through 3;
- Laboratory testing of representative samples obtained during our subsurface evaluation (Appendix C);
- Preparation of a geotechnical map (Sheets 1 through 3) and cross sections (Sheets 4 and 5) depicting the interpreted geologic conditions on the site;
- Performance of slope stability analysis on the pertinent geotechnical cross sections;
- Geotechnical analysis of the data reviewed/obtained; and
- Preparation of this report presenting our findings, conclusions and preliminary recommendations along with response to city review comments with respect to the proposed site development.

Please note that potential environmental issues pertaining to the site were not evaluated by LGC Geotechnical.

### **1.2 Project Description and Existing Conditions**

The site is an elongated, irregularly shaped, approximately 15.4-acre property located southeast of the Harbor Freeway (I-110) and northwest of John S. Gibson Boulevard in the City of Los Angeles, California (see Site Location Map, Figure 1).

Topographically, the site consists of a nearly level terrace area adjacent to the Harbor Freeway (I-110) with an approximately 2:1 (horizontal to vertical) slope along the southeastern side of the property descending down to John S. Gibson Boulevard. The site is currently unoccupied except for remnants of two abandoned cellular communication towers, a partially paved access

road, surface and buried oil pipelines and utilities. Three concrete culverts cross under the Harbor Freeway and outlet to the subject site.

Based on our aerial photograph review and review of old topographic maps, the site appears to consist of a large graded pad with approximately 2:1 (horizontal to vertical) graded slopes descending to the southeast. The site and surrounding slopes appear to consist almost entirely of cut native materials. It would appear that up to approximately 20 vertical feet of material has been removed from above the current existing onsite grades and possibly as much as 80 vertical feet of material may have been removed in the area of the slopes that descend from the site. It is possible that the site was used as a borrow site for fill material utilized in construction of the Port of Los Angeles.

Based on the provided information, the proposed development will consist of a flat parking area for 18-wheel trucks and trailers, an access road, and associated utilities. Proposed grading will include retaining walls up to approximately 30 feet in height and fill slopes up to 45 feet in height (Thienes, 2018). It is our understanding that no habitable building structures are planned within the proposed development. Retaining wall structures will include six Mechanically Stabilized Earth (MSE) retaining walls (“A” through “E” and “H”) up to approximately 30 feet in height and two top-down constructed soldier pile retaining walls (“F” and “G”) up to approximately 12.5 feet in height. Planned MSE retaining walls will be near vertical (essentially no wall batter) reinforced with inextensible steel strips. We have estimated that planned finish grades will be achieved with cuts and fills up to approximately 30 to 35 feet from existing grades, respectively.

### **1.3 Background**

In 2005 Lawson & Associates Geotechnical Consulting (Lawson) performed a preliminary geotechnical evaluation for the development of the proposed self-storage facility (Lawson, 2005). The field evaluation consisted of the excavation, sampling, and down-hole logging of three large-diameter borings (LGC-1 through LGC-3) to a maximum depth of approximately 61 feet below existing ground surface and one Cone Penetration Test (CPT-1) sounding to a depth of approximately 20 feet below the ground surface. The CPT sounding was terminated due to refusal of the cone tip.

In 2007 Lawson performed a supplemental geotechnical investigation for the proposed San Pedro Storage development (Lawson, 2007a). The field evaluation consisted of excavation, sampling, and down-hole logging of two large-diameter borings (LGC-4 and LGC-5) in the area of the proposed access road to depths of up to approximately 60 feet below existing ground surface. Lawson subsequently responded to review comments by the Port of Long Beach (Lawson, 2007b). It is our understanding that the response report was geotechnically approved by the Port of Long Beach.

In 2012 LGC Geotechnical, Inc. (LGC Geotechnical) assumed responsibility as geotechnical consultant of record for the site which was the subject of the previous Lawson geotechnical reports (Lawson, 2005, 2007a & b). The northerly extension of the site necessitated additional geotechnical field explorations, laboratory testing and analysis as provided herein.

#### **1.4 Subsurface Evaluation**

Our subsurface evaluation consisted of the excavation, sampling, and downhole logging of six large-diameter borings (LGC-BA-1 through LGC-BA-6) to a maximum depth of approximately 71 feet below existing ground surface. Boring LGC-BA-5 was terminated at a depth of approximately 17 feet below existing grade due to strong petroliferous odor within the excavated material. The visual log was terminated in LGC-BA-4 at a depth of approximately 14 feet below existing grade due to unsafe conditions in friable, caving sands. The borings were logged from the surface during excavation and following the completion of the hole, provided safe conditions were present, the large-diameter borings were downhole logged by a geologist from our firm. The borings were excavated to evaluate the general engineering characteristics of the onsite soils. Subsequent to the subsurface evaluation, the borings were backfilled with native soils to the surface and tamped. Some settlement of the backfill soils may occur over time.

The approximate locations of the borings are shown on our Geotechnical Map, Sheets 1 through 3 and the logs presented in Appendix B. The previous boring and CPT logs (Lawson 2005 and 2007a) are also presented in Appendix B.

#### **1.5 Laboratory Testing**

Representative driven and bulk samples were retained for laboratory testing during our field evaluation. Laboratory testing was performed at a certified geotechnical testing laboratory for the City of Los Angeles (Leighton). We have reviewed and concur with the test results and accept the responsibility for their use in our analysis. Laboratory testing included in-situ unit weight and moisture content, sieve and hydrometer, fines content, Atterberg Limits, direct shear, laboratory compaction and corrosion (sulfate, chloride, pH, and minimum resistivity). The following is a summary of the laboratory test results.

- Dry density of the samples collected ranged from approximately 88 pounds per cubic foot (pcf) to 112 pcf, with an average of 102 pcf. Field moisture contents ranged from approximately 1 percent to 30 percent, with an average of 11 percent.
- Eight fines content/gradation tests indicated a fines content (percent passing No. 200 sieve) ranging from approximately 13 percent to 77 percent. Based on the Unified Soils Classification System (USCS), seven of the tested samples are classified as “coarse-grained.”
- Five Atterberg Limits tests were performed. Results indicated Plasticity Index values of 12 and 17 for two of the samples with the remaining three samples as “Non-Plastic.”
- Three laboratory compaction tests indicated a maximum dry density values ranging from 113.5 pcf to 129.0 pcf with optimum moisture contents ranging from 8.0 to 13.5 percent.
- Two direct shear tests were performed on a driven undisturbed samples and one direct shear on a sample remolded to 90 percent relative compaction. The plots are provided in Appendix C.
- Corrosion testing of three bulk samples indicated soluble sulfate content values less than approximately 0.04 percent, chloride content values ranging from 70 parts per million (ppm) to 84 ppm, pH values ranging from 7.1 to 8.3, and minimum resistivity values ranging from 1,098 ohm-cm to 1,685 ohm-cm.

A summary of the laboratory test results is presented in Appendix C. The previous laboratory test results (Lawson 2005 & 2007a) are also provided in Appendix C. Please note that Lawson and Associates Geotechnical Consulting (Lawson) was a certified geotechnical testing laboratory for the City of Los Angeles at the time of the report (Lawson, 2007a).





Approximate Site Location



**FIGURE 1**  
**Site Location Map**

PROJECT NAME	San Pedro Distribution Center
PROJECT NO.	12091-01
ENG. / GEOL.	BTZ / KBC
SCALE	Not to Scale
DATE	February 2019



## **2.0 GEOTECHNICAL CONDITIONS**

### **2.1 Regional Geology**

The site is located within the Los Angeles Basin bordering the uplands of the Palos Verdes Peninsula. The Los Angeles Basin is comprised of thousands of vertical feet of sedimentary deposits. The region has a complex geologic history including periods of uplift, subsidence, sea-level transgression and regression, and folding and faulting.

Based on our review of the State of California Seismic Hazard Zone Maps for Torrance 7.5 Minute Quadrangle (CGS, 1986, 1998 & 2018b), the site is not located within a liquefaction zone or Alquist-Priolo Earthquake Fault Zone; however, a zone of potential earthquake induced landslides is depicted in the southern portion of the site.

### **2.2 Site-Specific Geology**

The site is comprised of older marine terrace deposits and isolated areas of undocumented fill associated with dirt roads and onsite utility construction. A small landslide is present in the descending slope in the approximate central portion of the site (see Sheet 2). Colluvium is likely to be encountered during grading on the existing slopes. The typical onsite characteristics of the materials are described in the following subsections (from youngest to oldest). The approximate aerial extent of the geologic units is provided on the Geotechnical Map and the interpolated subsurface conditions are depicted on the geotechnical cross sections (Sheets 4 & 5).

#### **2.2.1 Artificial Fill – Undocumented (Map Symbol – afu)**

Localized areas of undocumented fill were observed. The isolated areas of undocumented fill appear to be associated with the oil pipelines at the central portion of the site, an existing storm drain in the northern portion of the site, and the current access road. These fill soils were observed to extend approximately fifteen feet below existing ground level in borings LGC-BA-3 and LGC-BA-5. Other areas of undocumented fill soils were observed to be thin and discontinuous throughout the site and were not mapped due to their limited extent. The undocumented artificial fill soils were observed to primarily consist of dry to moist, sands, silty sands, clays, sandy clays, and silts. Undocumented fill soils encountered in LGC-BA-5 were petroleum affected with black staining and petroliferous odor.

#### **2.2.2 Artificial Fill – Older (Map Symbol – afo)**

Older artificial fill is present in the southeastern portion of the site. The older artificial fill soils are associated with nearby existing buildings and John S. Gibson Boulevard.

### **2.2.3 Topsoil/Colluvium**

A veneer of colluvial material will likely be encountered mantling the slope face during grading. This material is anticipated to be generally on the order of 1 to 2 feet in thickness, but should be expected to thicken towards the base of the slope. These materials are expected to consist of loose deposits of terrace-derived materials, with high organic content, common roots and rootlets. These materials should be considered unsuitable for placement of additional fill or for support of structural loads.

### **2.2.4 Quaternary Landslide Deposit (Map Symbol - Qls)**

A small landslide is present on the slope that descends from the central portion of the site and was observed in LGC-BA-2 (see Geotechnical Map and Appendix B). This landslide appears to be a remnant of a larger failure, the majority of which appears to have been removed during previous grading of the slope. The landslide deposit was observed to consist of offset and shifted interbedded sandstone and siltstone with a basal rupture surface.

### **2.2.5 Old Marine Terrace Deposits (Map Symbol - Qom)**

The majority of the site consisted of old marine terrace deposits to at least the maximum depth explored (approximately 71 feet). As encountered, the marine terrace deposits consisted of friable to weakly cemented fine sandy siltstone and fine-grained sandstone, generally slightly moist to moist.

## **2.3 Geologic Structure**

Joints and shears were discernable in some of the subsurface excavations. No regional foliation and/or fracturing or jointing trend have been observed on the site. Bedding encountered within the terrace materials observed in our borings generally dips on the order of 8 degrees to the north and east. Localized cross bedding within the terrace was also observed.

No faults were encountered during our field study. The approximate location of projected faults associated with the Palos Verdes fault zone are depicted on the regional geologic map of the area (CGS, 2016) and are included on our Geotechnical Map (Sheets 1 through 3), crossing the site in a roughly northwest/southeast trend. Further discussion of the Palos Verdes fault zone is provided in Section 2.6.

## **2.4 Landslides**

A small landslide was identified during our geologic mapping of the site. The approximate aerial extent of the landslide is depicted on our Geotechnical Map (Sheets 1 through 3). It would appear that the lower portion of this landslide might have been trimmed back during construction of John S. Gibson Boulevard.

Based on our review of the State of California Seismic Hazard Zones Torrance 7.5 Minute Quadrangle (CGS, 1998 & 2018b), a zone of potential earthquake induced landslides has been depicted in the southern portion of the site. No existing landslides were observed in this portion of the site. The zone appears to be associated with the area of previous access road grading. This area will be regraded as part of the proposed site development.

## **2.5 Groundwater**

Groundwater was not encountered during this subsurface evaluation to the total explored depth of 71 feet below existing ground. However, groundwater was encountered in previous evaluations at approximate depths of 57, 50, and 38 feet below existing ground surface in borings LGC-2, LGC-3, and LGC-5, respectively (Lawson, 2005 & 2007a). As encountered, the depth of the groundwater is consistent with the regional groundwater table mapped as being at an elevation of approximately 10 feet above mean sea level (msl) (CGS, 1998).

Groundwater levels are subject to seasonal variation, tidal fluctuations, and man-made influences such as water injection and pumping of water wells. Groundwater levels also fluctuate with the seasons and local zones of perched groundwater may be present within the near-surface deposits due to local seepage or during rainy seasons. Local groundwater conditions should be expected to change once site development is completed and landscape irrigation commences. If groundwater seepage is encountered, mitigation recommendations can be provided to reduce the impact of ground water seepage or saturated conditions.

## **2.6 Faulting**

California is located on the boundary between the Pacific and North American Lithospheric Plates. The average motion along this boundary is on the order of 50-mm/yr in a right-lateral sense. The majority of the motion is expressed at the surface along the northwest trending San Andreas Fault Zone with lesser amounts of motion accommodated by sub-parallel faults located predominantly west of the San Andreas including the Elsinore, Newport-Inglewood, Rose Canyon, and Coronado Bank Faults. Within Southern California, a large bend in the San Andreas Fault north of the San Gabriel Mountains has resulted in a transfer of a portion of the right-lateral motion between the plates into left-lateral displacement and vertical uplift. Compression south and west of the bend has resulted in folding, left-lateral, reverse thrust faulting, and regional uplift creating the east-west trending Transverse Ranges and several east-west trending faults. Further south within the Los Angeles Basin, "blind thrust" faults are believed to have developed below the surface also as a result of this compression, which have resulted in earthquakes such as the 1994 Northridge event along faults with little to no surface expression.

Prompted by damaging earthquakes in Northern and Southern California, State legislation and policies concerning the classification and land-use criteria associated with faults have been developed. The Alquist-Priolo Earthquake Fault Zoning Act was implemented in 1972 to prevent the construction of urban developments across the trace of active faults. California Geologic Survey Special Publication 42 was created to provide guidance for following and implementing the law requirements. Special Publication 42 was most recently revised in 2018 (CGS, 2018a).



According to the State Geologist, an “active” fault is defined as one which has had surface displacement within Holocene time (roughly the last 11,700 years). Regulatory Earthquake Fault Zones have been delineated to encompass traces of known, Holocene-active faults to address hazards associated with surface fault rupture within California. Where developments for human occupation are proposed within these zones, the state requires detailed fault evaluations be performed so that engineering-geologists can identify the locations of active faults and recommend setbacks from locations of possible surface fault rupture.

The subject site is not located within an Alquist-Priolo Earthquake Fault Zone and no faults were identified on the site during our site evaluation or previous evaluations. However, the site is located within the Palos Verdes Preliminary Fault Study Zone, as defined by the City of Los Angeles (LADBS, 2014). A fault evaluation was not performed because the proposed development is classified as Group U Occupancy, with proposed structures being of an accessory character, and is exempted from investigations in Alquist-Priolo Fault Study Zones or City of Los Angeles Preliminary Fault Rupture Study Areas (LADBS, 2018).

The approximate location of projected faults associated with the Palos Verdes fault zone are depicted on the regional geologic map of the area (CGS, 2016) and are included on our Geotechnical Map (Sheets 1 through 3), crossing the site in a roughly northwest/southeast trend.

The three suspected fault traces are inferred to be in the southern half of the site. However, the onshore portion of the Palos Verdes fault is not considered to be active (CGS 1986, 2010, & 2018b). It is also important to note that the traces shown are only the “inferred position” of the Palos Verdes Fault based on projection and structural inference, faults have not been observed at these locations.

The possibility of damage due to ground rupture is considered low since no active faults are known to cross the site. The closest known active faults are the offshore portion of the Palos Verdes Fault Zone located less than a kilometer southeast of the subject site. The site is located at the transition between the Palos Verdes Hills and the San Pedro Shelf sections of the Palos Verdes Fault Zone. Holocene activity is recognized for the southern, offshore San Pedro Shelf section and late Quaternary (less than 15,000 years old) and possible Holocene activity is estimated for the Palos Verdes Hills Section (CGS, 2016 & Treiman, et al, 2017).

Secondary effects of seismic shaking resulting from large earthquakes on the major faults in the Southern California region, which may affect the site, include ground lurching and shallow ground rupture, soil liquefaction, and dynamic settlement. These secondary effects of seismic shaking are a possibility throughout the Southern California region and are dependent on the distance between the site and causative fault and the onsite geology. A discussion of these secondary effects is provided in the following sections.

### ***2.6.1 Lurching and Shallow Ground Rupture***

Soil lurching refers to the rolling motion on the ground surface by the passage of seismic surface waves. Effects of this nature are not likely to be significant where the thickness of soft sediments does not vary appreciably under structures.

Ground rupture due to active faulting is not likely to occur on site due to the absence of known active fault traces. Minor cracking of near-surface soils due to shaking from distant seismic events is not considered a significant hazard, although it is a possibility at any site, and is often associated with ridgelines.

Damage due to surface ground rupture within the project area is considered possible due to the presence of the Palos Verdes fault zone crossing the project alignment. However, since the onshore segment of the fault is classified as inactive, the probability is likely low. Surface ground cracking related to shaking from distant events is not considered a significant hazard for a majority of the project area, although it is a possibility. The southern portion of the moderately sloping terrain between the site and John S. Gibson Boulevard is located within an area considered susceptible to earthquake-induced land movement (CGS, 1998). This designation is likely made due to the moderate site topography in combination with the relatively cohesionless nature of the site soils, and the potential for adverse geologic structure. The results of our slope stability analysis are presented in Section 2.8.

### **2.6.2 Liquefaction and Dynamic Settlement**

Liquefaction is a seismic phenomenon in which loose, saturated, granular soils behave similarly to a fluid when subject to high-intensity ground shaking. Liquefaction occurs when three general conditions coexist: 1) shallow groundwater; 2) low density non-cohesive (granular) soils; and 3) high-intensity ground motion. Studies indicate that loose, saturated, near surface cohesionless soils exhibit the highest liquefaction potential, while dry, dense, cohesionless soils and cohesive soils exhibit low to negligible liquefaction potential. In general, cohesive soils are not considered susceptible to liquefaction depending on their plasticity and moisture content (Bray & Sancio, 2006). Effects of liquefaction on level ground include settlement, sand boils, and bearing capacity failures below structures.

The site is not located in a California Seismic Hazard zone for liquefaction (CDMG, 1999). The potential for site liquefaction is considered low since the developed site will consist of compacted fill over dense native soils.

### **2.6.3 Lateral Spreading**

Lateral spreading is a type of liquefaction induced ground failure associated with the lateral displacement of surficial blocks of sediment resulting from liquefaction in a subsurface layer. Once liquefaction transforms the subsurface layer into a fluid mass, gravity plus the earthquake inertial forces may cause the mass to move downslope towards a free face (such as a river channel or an embankment). Lateral spreading may cause large horizontal displacements and such movement typically damages pipelines, utilities, bridges, and structures.

Due to the low potential for liquefaction the potential for lateral spreading is also considered low.

#### **2.6.4 Tsunamis and Seiches**

A small portion of the site is located in a zone of potential Tsunami Inundation according to the California Emergency Management Agency map for the area (CEMA, 2009). Based on the relatively short distance of the site from San Pedro Bay and the Pacific Ocean, the possibility of seiches and/or tsunamis affecting the site lower portions of the site is considered to be moderate. Please note that the occurrence of such events in this area is extremely rare.

#### **2.7 Seismicity**

The site seismic characteristics were evaluated per the guidelines set forth in Chapter 16, Section 1613 of the 2016 California Building Code (CBC)/2017 City of Los Angeles Building Code (LABC). Representative site coordinates of latitude 33.7669 degrees north and longitude - 118.2819 degrees west were utilized in our analyses. The maximum considered earthquake (MCE) spectral response accelerations ( $S_{MS}$  and  $S_{M1}$ ) and adjusted design spectral response acceleration parameters ( $S_{DS}$  and  $S_{D1}$ ) for Site Class D are provided in Table 1.

**TABLE 1**

**Seismic Design Parameters**

<b>Selected Parameters from 2016 CBC, Section 1613 - Earthquake Loads</b>	<b>Seismic Design Values</b>
Site Class per Chapter 20 of ASCE 7	D
Risk-Targeted Spectral Acceleration for Short Periods ( $S_S$ )*	1.688g
Risk-Targeted Spectral Accelerations for 1-Second Periods ( $S_1$ )*	0.652g
Site Coefficient $F_a$ per Table 1613.3.3(1)	1.0
Site Coefficient $F_v$ per Table 1613.3.3(2)	1.5
Site Modified Spectral Acceleration for Short Periods ( $S_{MS}$ ) for Site Class D [Note: $S_{MS} = F_a S_S$ ]	1.688g
Site Modified Spectral Acceleration for 1-Second Periods ( $S_{M1}$ ) for Site Class D [Note: $S_{M1} = F_v S_1$ ]	0.978g
Design Spectral Acceleration for Short Periods ( $S_{DS}$ ) for Site Class D [Note: $S_{DS} = (2/3)S_{MS}$ ]	1.125g
Design Spectral Acceleration for 1-Second Periods ( $S_{D1}$ ) for Site Class D [Note: $S_{D1} = (2/3)S_{M1}$ ]	0.652g
Mapped Risk Coefficient at 0.2 sec Spectral Response Period, $C_{RS}$ (per ASCE 7)	0.910
Mapped Risk Coefficient at 1 sec Spectral Response Period, $C_{R1}$ (per ASCE 7)	0.907

\* From USGS, 2018

Section 1803.5.12 of the 2016 CBC (per Section 11.8.3 of ASCE 7) states that the maximum considered earthquake geometric mean ( $MCE_G$ ) Peak Ground Acceleration (PGA) should be used for liquefaction potential. The  $PGA_M$  for the site is equal to 0.69g (USGS, 2018). Thereby, the design PGA for the site may be taken as 2/3 of the  $PGA_M$  ( $2/3$  of 0.69g) = 0.46g

A deaggregation of the PGA based on a 2,475-year average return period indicates that an earthquake magnitude of 7.0 at a distance of approximately 3.2 km from the site would contribute the most to this ground motion. A deaggregation of the PGA based on a 475-year average return period indicates that an earthquake magnitude of 6.8 at a distance of approximately 13.0 km from the site would contribute the most to this ground motion (USGS, 2008).

## 2.8 Slope Stability

The soil shear strength parameters utilized in our slope stability analysis are based on laboratory testing and published shear strength data (CGS, 1998). The along bedding shear strength is based on published shear strength correlations (Liquid Limit) for drained fully-softened friction angle (Stark and Hussain, 2013). Where applicable, soil shear strength parameters for seismic loading conditions were increased (below composite peak strength). Table 2 summarizes the static shear strength parameters utilized in our analysis. Refer to Appendix C.

**TABLE 2**

**Soil Shear Strength Parameters**

<b>Soil Type</b>	<b><math>\phi</math> (Degrees)</b>	<b>Cohesion (psf)</b>
Compacted Fill (af)	30	100
Terrace Deposits (Qom)	32	200
Along Bedding	20	0
Undocumented Fill (afu)	18	50

Slope stability analysis was performed on a two-dimensional cross-sectional model (Cross-Sections A-A' through I-I') positioned throughout the site. Slope stability analysis was performed using the computer program GSTABL7 with STEDwin version 2.005.3 (Gregory Geotechnical Software, 2013). Potential rotational and block surfaces were analyzed using Bishop's Modified Method and Janbu's Simplified Method, respectively. Slope stability analysis was performed for static and seismic loading conditions. A minimum factor of safety of 1.5 is typically required for static loading conditions.

Seismic slope stability analysis was performed per Special Publication 117A (2008). Special Publication 117A requires a "screening" slope stability calculation based on modified horizontal seismic coefficient ( $K_h$ ) derived from site-specific seismic parameters (i.e., design PGA, earthquake magnitude and distance) based on a 15-cm threshold. If the resulting calculated factor of safety is equal to or greater than 1.0, the analyses passes the screening calculation and no further analyses is required. If the calculated factor of safety is less than 1.0, a displacement analyses is required in order to assess estimated slope movement during a seismic event. Based on site-specific parameters for the design earthquake a horizontal seismic coefficient ( $K_h$ ) of 0.18 was determined for screening. The resulting "screening" factor of safety was greater than 1.0 thereby no additional analyses were required.

For the cross sections with MSE walls, a very-high shear strength (friction angle of 40 degrees and cohesion of 5,000 psf) was used to force potential failure surfaces around the reinforced zone for global stability analysis. The reinforced zone was conservatively estimated at 0.7 times the height of the MSE wall.

Slope stability analysis indicated adequate factors of safety. Slope stability analysis is provided in Appendix D.

## **2.9 Rippability**

Based on our understanding of the proposed development, most of the proposed cuts will be relatively shallow. The results of our subsurface evaluation indicate that the majority of the material to be encountered during site grading should generally be considered rippable with heavy-duty grading equipment (assume D-9 Dozer). However, localized areas requiring additional ripping effort may be encountered.

## **2.10 Oversized Material**

Generation of a surplus of oversized material (material greater than 8 inches in maximum dimension) is generally not anticipated during site grading. However, some oversized material may be encountered, which may result in excavation difficulty for narrow excavations. Recommendations are provided for appropriate handling of oversized materials in Appendix E.

## **2.11 Expansive Soil Characteristics**

Generally, the onsite soils should be expected to have a very low to low potential for expansion. Previous expansion potential testing indicated an expansion index of 15, "Very Low" ( $EI \leq 20$ ) (Lawson, 2005). While isolated areas of higher expansion may be encountered, mixing with the less expansive soils, which comprise the majority of the site, may help dilute these materials.

## **2.12 Corrosion Potential**

Corrosion testing of three samples indicated soluble sulfate content values less than approximately 0.04 percent, chloride content values ranging from 70 parts per million (ppm) to 84 ppm, pH values ranging from 7.1 to 8.3, and minimum resistivity values ranging from 1,098 ohm-cm to 1,685 ohm-cm. Previous corrosion testing indicates a soluble sulfate content less than 0.01 percent, chloride content of 33 ppm, pH of 8.2 and a minimum resistivity of 5,100 ohm-centimeters (Lawson, 2005).

### **3.0 CONCLUSIONS**

Based on the results of our subsurface evaluation and geotechnical review of the grading plan, it is our opinion that the proposed development is feasible from a geotechnical standpoint, provided the recommendations contained in the following sections are incorporated during site grading and construction. A summary of our geotechnical conclusions follows:

- Based on our site visit and review of pertinent geologic maps and reports, the site is underlain primarily with older marine terrace deposits, a small landslide, and localized zones of up to approximately 15 feet of undocumented fill overlaying terrace deposits.
- The site contains undocumented fill and native soils, not suitable for the proposed development in their current condition. Removal and recompaction will be required.
- A static groundwater table is present at an elevation of approximately 10 feet above mean sea level. Groundwater levels will vary based on tidal influences. Stabilization of the subgrade for removal bottoms within approximately 2 feet of site groundwater should be anticipated by the contractor prior to subsequent fill placement.
- In general, our borings indicate that the site contains primarily sands with varying amounts of silt with occasional clays and gravels to the maximum explored depth of approximately 70 feet below existing grade. The near-surface loose and compressible soils, landslide material, and previously placed undocumented fill soils should be removed to suitable native materials within the zone of influence of structural improvements (refer to Section 4.1).
- From a geotechnical perspective, onsite soils are anticipated to be suitable for use as general compacted fill provided, they are screened of organic materials, construction debris and any oversized material (8 inches in greatest dimension). With regards to potential contamination, material to be used as fill must also be determined to be suitable by the project environmental consultant.
- No active faults are known to exist on the site. The Palos Verdes fault zone has been inferred to cross the site at three locations. The onshore portion of the Palos Verdes fault is not considered to be active. The main seismic hazard that may affect the site is from ground shaking from one of the active regional faults. The subject site will likely experience strong seismic ground shaking during its design life.
- Based on our review of the State of California Seismic Hazard Zone Map a zone of potential earthquake induced landslides has been depicted in the southern portion of the site. However, slope stability analysis indicates adequate static and seismic factors of safety. The mapped landslide located in the central portion of site will be mitigated by the proposed grading and the recommendations provided herein.
- The site is not located in a California Seismic Hazard Zone for liquefaction. Due to the developed site consisting of compacted fill over dense native soils the potential for liquefaction is considered low.
- Existing slopes to remain adjacent to the development are anticipated to be grossly stable; however, surficial erosion may occur.
- Cut slopes and sliver fill slopes should be trimmed back a minimum of one equipment width (15 feet) and replaced with compacted fill. Refer to Section 4.2.3 "Stabilization Fills" and Sheet 1 for locations.

- Sandy, relatively cohesionless soils (less than 15 percent finer than 0.005 millimeters) are present and must be compacted to at least 95 percent relative compaction (per ASTM D1557) per the requirements of the City of Los Angeles. Contractor should anticipate sandy soils with low fines content are present thereby requiring at least 95 percent relative compaction.
- Based on our field evaluation, site soils are generally sandy and sometimes friable, which make them susceptible to caving during excavation. Caving sands were encountered in Boring LGC-BA-4 at a depth of approximately 14 feet below existing grade. This may impact excavations during construction, especially drilling of boreholes for the soldier pile retaining walls. Refer to the boring logs provided in Appendix B.
- It is anticipated that the onsite materials should be considered rippable with standard grading equipment.
- Generation of significant amounts of oversized material is not anticipated during site grading.
- Due to the hillside nature of the site, the presence of compacted fill underlain by dense native soils, proposed retaining wall structures and 2:1 slopes, it is our opinion that purposeful infiltration at the subject site is infeasible from a geotechnical and regulatory standpoint and therefore should not be performed.



#### **4.0 PRELIMINARY RECOMMENDATIONS**

The following recommendations are to be considered preliminary and should be confirmed upon completion of earthwork operations. In addition, they should be considered minimal from a geotechnical viewpoint, as there may be more restrictive requirements from the architect, structural engineer, building codes, governing agencies, or the City. It is the responsibility of the builder to ensure these recommendations are provided to the appropriate parties.

It should be noted that the following geotechnical recommendations are intended to provide sufficient information to develop the site in general accordance with the 2016 California Building Code (CBC)/2017 City of Los Angeles Building Code requirements. With regard to the potential occurrence of potentially catastrophic geotechnical hazards such as fault rupture, earthquake-induced landslides, liquefaction, etc. the following geotechnical recommendations should provide adequate protection for the proposed development to the extent required to reduce seismic risk to an “acceptable level.” The “acceptable level” of risk is defined by the California Code of Regulations as “the level that provides reasonable protection of the public safety, though it does not necessarily ensure continued structural integrity and functionality of the project” [Section 3721(a)]. Therefore, repair and remedial work of the proposed improvement may be required after a significant seismic event. With regards to the potential for less significant geologic hazards to the proposed development, the recommendations contained herein are intended as a reasonable protection against the potential damaging effects of geotechnical phenomena such as expansive soils, fill settlement, groundwater seepage, etc. It should be understood, however, that although our recommendations are intended to maintain the structural integrity of the proposed development and structures given the site geotechnical conditions, they cannot preclude the potential for some cosmetic distress or nuisance issues to develop as a result of the site geotechnical conditions.

The geotechnical recommendations contained herein must be confirmed to be suitable or modified based on the actual exposed conditions.

#### **4.1 Site Earthwork**

We anticipate that earthwork will consist of demolition of existing improvements, required removals, subgrade preparation, retaining wall and utility line construction. We recommend that earthwork onsite be performed in accordance with the following recommendations, City of Los Angeles Building Code (LABC) requirements and the General Earthwork and Grading Specifications included in Appendix E. In case of conflict, the following recommendations shall supersede those included in Appendix E. The following recommendations should be considered preliminary and may be revised based upon future evaluation and our review of updated project plans and/or the field conditions exposed during construction.

##### **4.1.1 Site Preparation**

Prior to grading of areas to receive structural fill or engineered structures, the areas should be cleared of surface obstructions and potentially compressible material (such as

landslide material, undocumented fill, weathered terrace, colluvium, and vegetation). Vegetation and debris should be removed and properly disposed of offsite. Holes resulting from the removal of buried obstructions, which extend below proposed removal bottoms should be replaced with suitable compacted fill material.

If cesspools or septic systems are encountered during earthwork, they should be removed in their entirety. The resulting excavation should be backfilled with properly compacted fill soils. As an alternative, cesspools can be backfilled with lean sand-cement slurry. At the conclusion of the clearing operations, a representative of LGC Geotechnical should observe and accept the site prior to further earthwork.

#### **4.1.2 Removal Depths and Limits**

Potentially compressible/collapsible materials not removed by the planned design cuts should be excavated to competent material and replaced with compacted fill soils. For preliminary planning purposes, the depth of remedial grading/required removals may be estimated as shown on the Geotechnical Map (Sheets 1 through 3) and discussed herein.

In general, it is anticipated that removal bottoms, which extend to within approximately 2 feet above site groundwater or closer, may be difficult to stabilize prior to subsequent fill placement. Refer to Section 4.1.5 "Subgrade Preparation."

Undocumented fill Soils: Where not removed by the proposed grading, the previously placed undocumented fill soils within the limits of the site should be removed to competent native soils within the zone of influence of structural improvements.

Existing Landslide: Where not removed by the proposed grading, the existing landslide within the limits of the site should be completely removed to competent native soils.

MSE Retaining Walls: Subgrade for the MSE walls (e.g. leveling pad and reinforcement zone) should consist of firm, relatively unyielding native soils or properly placed compacted fill soils. If loose, compressible soils or undocumented fill soils are encountered they should be completely removed and replaced with properly placed compacted fill soils.

Pavement and Hardscape Areas: Removals should extend to a depth of at least 2 feet below the existing grade. Removals in any design cut areas of the pavement may be reduced by the depth of the design cut but should not be less than 1-foot below the finished subgrade (i.e., below planned aggregate base below concrete or asphalt concrete section). In general, the envelope for removals should extend laterally a minimum lateral distance of 2 feet beyond the edges of the proposed improvements.

Local conditions may be encountered during grading that could require additional removals beyond the above-noted minimum in order to obtain an acceptable subgrade. The actual depths and lateral extents of grading will be determined by the geotechnical consultant, based on subsurface conditions encountered during grading.

#### **4.1.3 Temporary Excavations**

Based on the proposed grading plan, excavations up to approximately 60 feet are anticipated. Excavations should be sloped back to 1:1 inclination or flatter or be properly shored. Temporary excavations should be performed in accordance with project plans, specifications, and Occupational Safety and Health Administration (OSHA) requirements. Soil conditions should be regularly evaluated during construction to verify conditions are as anticipated. The contractor shall be responsible for providing the “competent person,” required by OSHA standards, to evaluate soil conditions. Prolonged exposure of backcut slopes during construction may result in localized slope instability. Excavation safety is the responsibility of the contractor. Raveling of the sandy soils should be anticipated for temporary slopes. Flatter slope inclinations should be considered if raveling cannot be tolerated. The exposed slope surface may be kept surficially moist (but not saturated) during construction to reduce (not eliminate) potential sloughing.

Surcharge loads (soil stockpiles, construction equipment, etc.) should not be permitted within a horizontal distance equal to the height of cut from the top of the excavation or 5 feet from the top of the slope/excavation, whichever is greater, unless the cut is properly shored and designed for the applicable surcharge load. Excavations that extend below an imaginary plane inclined at 45 degrees below the edge of adjacent existing site facilities should be properly shored to maintain support of adjacent elements.

#### **4.1.4 Subdrains**

For planning purposes, the anticipated locations and elevations of recommended canyon subdrains to be constructed during site mass grading are depicted on the Geotechnical Map. The locations of the recommended subdrains are generally controlled by the natural site topography within the alluvial canyons/swales. In the case of the subject site, the need for canyon subdrains is anticipated in the two former canyons, which have been infilled with undocumented fill soils. Canyon subdrains should be placed following remedial grading and before fill placement within the “cleaned-out” channels, where undocumented fill is to be removed, on the exposed native soil removal bottoms to collect future groundwater that may accumulate/migrate in these areas along the native soil/fill contact. In areas where remedial grading will be deeper than available subdrain outlet elevations, fill placement will be performed until suitable subdrain flow elevations are achieved (minimum 2 percent flow towards the outlet location). In these areas, the primary purpose of the subdrains will be to reduce the potential for groundwater to rise above the subdrain elevations into the compacted fill. The canyon subdrains should be constructed in accordance with the recommendations provided in Appendix E.

Installation of subdrains along backcuts of recommended stabilization fill slopes is also recommended for site grading. The subdrains within stability fill slopes should be constructed in accordance with the appropriate recommendations provided in Appendix E.

If unanticipated groundwater or areas of potential future groundwater seepage and/or accumulation are encountered during grading, additional subdrains may be recommended by the geotechnical consultant.

Outletting of subdrains may require coordination with adjacent developments to tie into existing or future subdrainage systems on the adjacent sites. The outlet locations and elevations for the recommended subdrains are based on the design depicted on the rough-grading plan. Some variation in the actual location and elevation of the subdrains constructed during grading should be expected from the depictions on the Geotechnical Map.

A representative of the project civil engineer should survey the installed subdrains for alignment and grade prior to fill placement above the subdrains.

#### **4.1.5 Subgrade Preparation**

In general, areas to receive compacted fill should be scarified to a minimum depth of 6 inches, brought to a near-optimum moisture condition, and re-compacted per project recommendations. However, scarification is generally not required when the removal bottom is near (within approximately 2 feet above) groundwater. Pumping of the subgrade should be anticipated for removal bottoms excavated near site groundwater. For these conditions, stabilization of the subgrade may be required prior to placing compacted fill. In general, stabilization should be anticipated to consist of a minimum of 18 inches of crushed aggregate; however, the actual thickness of stabilization aggregate will have to be determined during earthwork based on field conditions. Stabilization aggregate should be placed in layers and compacted. It should be anticipated that the first lift of crushed aggregate will be worked into the pumping subgrade. Subsequent lifts will help bridge the pumping conditions. Soft and yielding subgrade should be evaluated on a case-by-case basis during earthwork operations.

Removal bottoms and areas to receive fill should be observed and accepted by the geotechnical consultant prior to subsequent fill placement.

#### **4.1.6 Material for Fill**

From a geotechnical perspective, the onsite soils are generally suitable for use as general compacted fill provided they are screened of oversized material (8 inches in greatest dimension), construction debris and significant organic materials.

Select backfill for MSE walls within “reinforced” zone should consist of sandy soils meeting the shear strength requirements outlined in Section 4.5 and the requirements of the MSE wall designer.

From a geotechnical perspective, import soils (if necessary) should consist of clean, granular soils of Very Low expansion potential (expansion index 20 or less based on ASTM D4829). Source samples of planned importation should be provided to the

geotechnical consultant for laboratory testing a minimum of three working days prior to any planned importation.

Aggregate base (crushed aggregate base or crushed miscellaneous base) should conform to the requirements of Section 200-2 of the Standard Specifications for Public Works Construction ("Green Book") for untreated base materials (except processed miscellaneous base) or Caltrans Class 2 aggregate base.

#### **4.1.7 Placement and Compaction of Fills**

Sandy, relatively cohesionless soils (less than 15 percent finer than 0.005 millimeters), fill soils should be compacted to at least 95 percent relative compaction (per American Society for Testing and Materials [ASTM] Test Method D1557) per the requirements of the City of Los Angeles. Soils with a higher fines content (greater than 15 percent finer than 0.005 millimeters) should be compacted to at least 90 percent relative compaction (per ASTM D1557). Contractor should anticipate sandy soils with low fines content are present in significant volume thereby requiring at least 95 percent relative compaction. Soils should be compacted near or within about 2 percent over optimum moisture content.

Moisture conditioning of site soils will be required in order to achieve adequate compaction. Drying and/or mixing the very moist soils will be required prior to reusing the materials in compacted fills. The optimum lift thickness to produce a uniformly compacted fill will depend on the type and size of compaction equipment used. In general, fill should be placed in uniform lifts not exceeding 8 inches in compacted thickness. Each lift should be thoroughly compacted and accepted prior to subsequent lifts. Generally, placement and compaction of fill should be performed in accordance with City of Los Angeles Building Code with observation and testing by the geotechnical consultant.

Fill placed on any slopes greater than 5:1 (horizontal to vertical) should be properly keyed and benched into firm and competent soils as it is placed in lifts. During backfill of excavations, the fill should be properly benched into firm and competent soils of temporary backcut slopes as it is placed in lifts.

Fill slope faces should also be compacted to minimum project recommendations. This may require overbuilding of the slope face and trimming back to design grades. To improve surficial stability, vegetation specified by the landscape architect should be established on the slope face as soon as it is practical, refer to Section 4.2.4.

For MSE wall backfill, it is imperative that adequate compaction meeting project recommendations be obtained in the zone immediately behind the facing units where compaction is typically achieved using hand equipment (e.g. whackers, etc.) instead of rubber-tired construction equipment.

Aggregate base material should be compacted to a minimum of 95 percent relative compaction at or slightly above optimum moisture content per ASTM D1557. The contractor should anticipate sandy subgrade soils with low fines content thereby

requiring at least 95 percent relative compaction at or slightly above optimum moisture content.

#### **4.1.8 Trench and Retaining Wall Backfill and Compaction**

The onsite soils may generally be considered suitable for use as trench backfill, provided the soils are screened of rocks, construction debris, other material greater than 6 inches in diameter and significant organic matter. If trenches are shallow or the use of conventional equipment may result in damage to the utilities, sand having a sand equivalent (SE) of 30 or greater (per Caltrans Test Method [CTM] 217) may be used to bed and shade the pipes within the bedding zone. Trench backfill should be compacted in uniform lifts (as outlined above in Section "Material for Fill") by mechanical means to project recommendations (as outlined above in Section "Placement and Compaction of Fills").

The proposed MSE Walls will require select sandy backfill soils as defined in the above Section "Material for Fill" to be placed within the "reinforced" zone as determined by the MSE wall designer. MSE backfill soils should be compacted in relatively uniform thin lifts to the applicable minimum relative compaction depending on the soil type (refer to above Section "Placement and Compaction of Fills"). Jetting or flooding of backfill materials is not permitted.

In backfill areas where mechanical compaction of soil backfill is impractical due to space constraints, typically Controlled Low Strength Material (CLSM) may be substituted for compacted backfill. The use of CLSM near the surface within landscape areas should be evaluated for potential impacts on planned improvements CLSM must meet the requirements of the City of Los Angeles Department of Building of Safety. The use of CLSM should meet the following criteria:

- The cement content of the CLSM should be a minimum of 188 pounds per cubic yard (2 sacks).
- Subgrade should be firm and competent and approved by the geotechnical consultant prior to placement of CLSM.
- Ultimate compressive strength of CLSM shall be a minimum of 100 pounds per square inch (psi) at 28 days per American Society for Testing Material (ASTM) Test Method D4832, Standard Test Method for Preparation and Testing of Controlled Low Strength Material Test Cylinders.
- Field tests are required to determine the acceptance of CLSM. There shall be a minimum of one test (2 cylinders) for each 50 cubic yards or fraction thereof.
- Contractor shall ensure that any required proposed footings bear entirely on CLSM. Under no circumstances shall a spread footing bear on a contact between CLSM and native or compacted fill soil.

A representative from LGC Geotechnical should observe, probe, and test backfill to verify compliance with the project recommendations.

#### **4.1.9 Shrinkage and Bulking**

Allowance in the earthwork volumes budget should be made for an estimated 5 to 10 percent reduction in volume of site soils. It should be stressed that these values are only estimates and that an actual shrinkage factor would be extremely difficult to predetermine. Subsidence due to earthwork equipment is expected to be on the order of 0.1-foot. These values are estimates only and exclude losses due to removal of any vegetation or debris. The effective shrinkage of onsite soils will depend primarily on the type of compaction equipment and method of compaction used onsite by the contractor.

### **4.2 Slope Stability**

#### **4.2.1 Existing Native Slopes**

Natural slopes will be left in their existing condition adjacent to portions of the site. These slopes will be subject to “natural” phenomena such as erosion, sloughing and surficial instabilities. It is impossible to predict where or when this may happen. Should erosion or slippage occur, it should be promptly repaired. Paramount in reducing the potential for either erosion or slippage is to properly maintain these slopes (refer to Section 4.2.4).

#### **4.2.2 Fill Slopes**

Design fill slopes at the site are anticipated to be stable as designed, as long as they are constructed in accordance with the Standard Earthwork and Grading Specifications included in Appendix E. Fill slopes should be constructed with a maximum slope ratio of 2:1 (horizontal to vertical). Slope faces should also be compacted to minimum project recommendations. This may require overbuilding of the slope face and trimming back to design grades. To improve surficial stability, vegetation specified by the landscape architect should be established on the slope face as soon as it is practical.

#### **4.2.3 Stabilization Fill Slopes**

The proposed grading for the slope south of the proposed site access road will result in a combination of thin cuts and “sliver” fills. Manufactured stabilization fill slopes are recommended in this area to ensure an appropriate minimum fill thickness behind the finished slope face. Stabilization fills should be constructed in accordance with the recommendations provided herein and included in Appendix E.

The approximate locations and bottom of key dimensions of the recommended stabilization fill keys are provided on the Geotechnical Map (Sheets 1 through 3). The locations and dimensions of the recommended keyways should be confirmed by the geotechnical consultant during grading. Some variation to the location and dimensions provided herein should be anticipated based on the conditions encountered.

Keyway widths should be a minimum of one-half of the total height of the slope or no less than 15 feet wide, whichever is greater. Keyways should be a minimum of 2 feet deep, determined from the lowest toe-of-slope elevation, and tilt back to the heel a minimum of 1-foot or 2 percent (whichever is greater). Stabilization fill backcuts should be excavated so that at least a minimum 15-foot-wide fill width is maintained for the entire height of the stabilization fill slope. In general, backcuts should be excavated at 2:1 (horizontal to vertical) inclinations. If grading limits do not allow sufficient room for maintaining 15-foot widths at 2:1 backcut inclinations, then portions of the backcut may be cut steeper to accommodate the stability fill slopes at the appropriate widths at the discretion of the geotechnical consultant. Properly outletted back drains should be constructed along stabilization fill backcuts.

In general, to reduce the potential for backcut failures, we recommend the keyway backcuts be planned to minimize the time the backcut is left exposed. The backcuts should not be initiated prior to forecasted rain or where they will be left open for extended periods, such as weekends.

Backcuts and key excavations should be geologically mapped by the geotechnical consultant during excavation to confirm the anticipated conditions. If adverse joints, fractures, and/or bedding are exposed, additional analysis and/or remediation measure may be required. The grading contractor must trim the backcuts with a slope board to remove loose material to allow for confirmational mapping.

#### ***4.2.4 Slope Maintenance Guidelines***

It is recommended that any graded slopes be planted with ground cover vegetation as soon as practical to protect against erosion by reducing runoff velocity. Deep-rooted vegetation that requires little water and is able to survive local climate conditions should also be established to protect against surficial slumping. Under no circumstances should slopes be allowed to be bare of vegetation. Landscape vegetation must not be “trimmed” to root structures leaving no protection of the slopes. Irrigation levels should be kept to the minimum level necessary to establish healthy plant growth. Slopes must not be overwatered. If automatic sprinklers are used, they must be adjusted during periods of rainfall. A landscape professional must be consulted for landscape recommendations.

A program for the elimination of burrowing animals in both native and graded slope areas must be established to protect slope stability by reducing the potential for surface water to penetrate into the slope face. Continuous erosion control, rodent control, and maintenance are essential to the long-term stability of slopes. Trenches excavated on a slope face for utility or irrigation lines and/or for any purpose must be properly backfilled and compacted to project recommendations (refer to Section 4.1.8) to the slope face. Observation/testing and acceptance by the geotechnical consultant during trench backfill are recommended. V-ditches should be inspected and cleared of loose soil and/or debris on a routine basis, especially prior to and during the rainy season.



### 4.3 Soldier Pile Walls

The following lateral earth pressures presented below may be used for design of permanent soldier pile walls. The provided equivalent fluid pressures do not include any hydrostatic pressures.

**TABLE 3A**

**Lateral Earth Pressures for Soldier Pile Walls**

Condition	Equivalent Fluid Unit Weight (pcf)	
	Level Backfill	2:1 Slope Above
Active	40	60

Retaining wall structures should be provided with appropriate drainage and appropriately waterproofed. Typically, a soldier pile wall is provided with a composite drainage mat (e.g., Miradrain, etc.) placed between the soldier piles and collected at the wall bottom and properly outletted to a suitable discharge point.

Surcharge loading effects from any adjacent structures should be evaluated by the retaining wall designer. In general, any slopes, building, equipment or traffic loads located within a 1:1 (horizontal to vertical) projection from the base of the soldier pile wall will surcharge the proposed retaining structure. If applicable, in addition to the recommended earth pressure a minimum additional uniform lateral pressure of 100 psf for the upper 10 feet should be added to the appropriate lateral earth pressures to account for typical vehicle traffic loading. Estimated surcharge loads on the retaining wall may be provided on a case-by-case basis based on the proposed layout (i.e., retaining wall height and corresponding horizontal distance and extent of surcharge). The retaining wall designer should contact the geotechnical consultant for any required geotechnical input in estimating surcharge loads.

For drilled piers spaced a minimum of three pile diameters on-center, an allowable passive pressure of 500 pcf may be used for passive resistance. The passive pressure incorporates an arching factor of 2 (e.g., 250 pcf x 2) and should be limited to a maximum of 12 times the value provided above (e.g., 500 pcf to a maximum of 6,000 psf). While not anticipated, passive pressure should be reduced for any piers extending below site groundwater at an elevation of 10 feet above msl. Below groundwater, an allowable passive pressure of 220 pcf (e.g., 110 pcf x 2) to a maximum of 12 times (e.g., 220 pcf to a maximum of 2,640 psf) may be used for passive resistance. Passive pressure values are only applicable for level (5 horizontal feet to 1-foot vertical or flatter) soil conditions. The upper foot of passive resistance should be neglected if finish grade is not covered with asphalt or concrete. To develop the full lateral value, provisions should be made to assure firm contact between the soldier piles and the undisturbed soils. The concrete placed in the soldier pile borehole excavation below the excavated level should be of adequate strength to transfer the imposed loads to the surrounding soils. The provided allowable passive pressure values are based on a factor of safety of 1.5. Retaining wall designer

should incorporate appropriate factors of safety in design.

Continuous lagging will be required between the soldier piles. Lagging should be placed in a timely manner during excavation in order to minimize potential spalling and sloughing. Due to the presence of sand layers encountered in explorations, spalling and sloughing should be anticipated and shorter excavation lifts may be required. Careful installation of the lagging will be necessary to achieve bearing against the retained earth. The backfill of the lagging should consist of one sack sand-cement slurry. The contractor should ensure full bearing of retained earth to the lagging. The soldier piles should be designed for the full anticipated lateral earth pressure. However, the pressure on the lagging will be less because of arching of the soils between piles. We recommend that the lagging be designed for the recommended lateral earth pressure but may be limited to a maximum value of 400 psf. Lagging placed behind the back flange of the soldier piles will negate the soil arching effect.

If required, the retaining wall designer may use the seismic lateral earth pressure increment as indicated in Table 3B. The seismic increment for the sloping backfill condition is based on the highest slope height. The seismic increment is based on a  $K_h$  equal to 0.23 using the City of Los Angeles requirement of computing  $K_h$  as one-half of two-thirds of the  $PGA_M$ . This seismic increment should be applied in addition to the provided static lateral earth pressure using a triangular distribution with the resultant acting at  $H/3$  in relation to the base of the retaining structure (where  $H$  is the retained height). Per Section 1803.5.12 of the 2016 CBC, the seismic lateral earth pressure is applicable to structures assigned to Seismic Design Category D through F for retaining wall structures supporting more than 6 feet of backfill height. This seismic lateral earth pressure is estimated using the procedure outlined by the Structural Engineers Association of California (Lew, et al, 2010) and the Federal Highway Administration (FHA, 2011). While not anticipated at this time, if a retaining wall and/or a sloping backfill condition greater than indicated in Table 3B is proposed, the retaining wall designer should contact the geotechnical engineer for specific seismic lateral earth pressure increments based on the proposed layout.

**TABLE 3B**

**Seismic Lateral Earth Pressure Increment**

Maximum Retained Height (feet)	Equivalent Fluid Unit Weight (pcf)	
	Level Backfill	2:1 Slope Above*
14	10	15

\*Maximum Slope Height of 15 feet

**4.4 MSE Retaining Walls**

The following soil shear strength parameters may be used for the planned MSE walls. A total soil unit weight of 120 pounds per cubic foot (pcf) may be used for reinforced, retained and

foundation soils. It is our understanding that soil cohesion is only used for foundation soils in design of the planned walls.

**TABLE 4**

**Soil Shear Strength Parameters for MSE Walls**

<b>Soil Zone</b>	<b><math>\phi</math> (Degrees)</b>	<b>Cohesion (psf)</b>
Foundation Soils	30	100
Reinforced Sandy Soils*	30	100
Retained Soils	30	100

Sandy select material will be required within the reinforced zone for local stability meeting strength requirements as outlined above for reinforced soils. Note that it is our understanding that for backfill of the proposed walls, it is desirable to use sandy materials with a low fines content. Based on the laboratory test results, it appears that the tested materials have a fines content on the order of 35 percent.

Where applicable, the MSE wall designer should account for site groundwater (e.g., allowable soil bearing, etc.). Groundwater is located at an elevation of approximately 10 feet above msl, refer to Section 2.5.

Heel drains are recommended for MSE walls constructed where the backcut adjacent to the end of the reinforcement is comprised of formational materials.

The reinforcement zone behind the wall should be considered a restricted use area where no future excavations should be made into the steel reinforcement, in order to protect the integrity of the wall. Damaging the steel reinforcement may result in negative consequences with respect to MSE wall stability and long-term durability. Project designers, construction contractors and any future owners should be made aware of this recommended restricted use area.

Global stability of the MSE wall configurations (surfaces beyond the estimated reinforced zone) was performed by LGC Geotechnical (refer to Section 2.8 and Appendix D). LGC Geotechnical should review MSE wall design plans to ensure adequate reinforcement lengths with respect to global stability requirements.

#### **4.5 Soil Bearing and Lateral Resistance**

The following allowable soil bearing and lateral resistance values may be used for minor site structures such as trash enclosures. It is our understanding that no habitable structures are proposed for the site. Proposed foundation elements should be supported on properly placed compacted fill or suitable native soils.

Provided our earthwork recommendations are implemented, an allowable soil bearing pressure of 1,500 pounds per square foot (psf) may be used for the design of footings having a minimum width of 18 inches and minimum embedment of 12 inches below lowest adjacent ground surface.

This value may be increased by 300 psf for each additional 12 inches of embedment and 300 psf for each additional foot of foundation width to a maximum value of 3,000 psf. These allowable bearing pressures are applicable for level (ground slope equal to or flatter than 5H:1V) conditions only. Bearing values indicated are for total dead loads and frequently applied live loads and may be increased by  $\frac{1}{3}$  for short duration loading (i.e., wind or seismic loads). This increase is based on a reduced factor of safety for short duration loading.

Resistance to lateral loads can be provided by friction acting at the base of foundations and by passive earth pressure. For concrete/soil frictional resistance, an allowable coefficient of friction of 0.25 (based on a factor of safety of 1.5) may be assumed with dead-load forces. An allowable passive lateral earth pressure of 240 pcf to a maximum of 2,400 psf may be used for lateral resistance for properly compacted fill and suitable dense native soils. This allowable passive pressure may be increased to 325 pcf to a maximum of 3,250 for short-duration seismic loading. For isolated pole footings (for items such as a deck, trellis, etc.) spaced a minimum of three pile diameters on-center, an allowable passive pressure of 480 pcf may be used for passive resistance. The provided passive pressure is based on an arching factor of 2 (e.g., 240 pcf x 2) and should be limited to a maximum of 10 times the value provided above (e.g., 480 pcf to a maximum of 4,800 psf). This value may be increased by one-third for short-duration seismic loading. While not anticipated, passive pressure should be reduced for any deepened foundation elements extending below site groundwater at an elevation of 10 feet above msl. Below groundwater, an allowable passive pressure of 220 pcf (e.g., 110 pcf x 2) to a maximum of 12 times (e.g., 220 pcf to a maximum of 2,640 psf) may be used for passive resistance. Groundwater may be taken at an elevation of 10 feet above msl. These provided passive pressures are applicable for level (ground slope equal to or flatter than 5H:1V) conditions only. Frictional resistance and passive pressure may be used in combination without reduction. We recommend that the upper foot of passive resistance be neglected if finished grade will not be covered with concrete or asphalt concrete. The provided allowable passive pressure is based on a static and seismic factor of safety of 1.5 and 1.1, respectively.

#### **4.6 Preliminary Pavement Sections**

The following preliminary minimum asphalt concrete (AC) pavement sections are provided in Table 5 based on an assumed R-value of 30 and assumed Traffic Indices of 6.0, 7.0 and 8.0. These recommendations must be confirmed with R-value testing of representative near-surface soils at the completion of earthwork and after underground utilities have been installed and backfilled. Determination of the Traffic Index (TI) is not the purview of the geotechnical consultant. Final pavement sections should be confirmed by the project civil/transportation engineer based upon the final design Traffic Index. If requested, LGC Geotechnical will provide sections for alternate TI values.

**TABLE 5**

**Asphalt Concrete Paving Section Options**

<b>Assumed Traffic Index</b>	6.0	7.0	8.0
<b>R-Value Subgrade</b>	30	30	30
<b>AC Thickness</b>	4.0 inches	5.0 inches	6.0 inches
<b>Base Thickness</b>	6.5 inches	7.5 inches	9.0 inches

The provided preliminary Portland Cement concrete section is based on the guidelines of the American Concrete Institute (ACI 330R-08). For the final design section, we recommend a traffic study be performed as LGC Geotechnical does not perform traffic engineering. Based on an assumed Traffic Category D with an assumed Average Daily Truck Traffic (ADTT) of 700, we recommend a preliminary section of a minimum of 8 inches of concrete over 4 inches of compacted aggregate base over compacted subgrade. The concrete should have a minimum compressive strength of 4,000 psi at the time the pavement is subjected to traffic. This pavement section assumes that edge restraints like a curb and gutter will be provided. To reduce the potential (but not eliminate) for cracking, paving should provide control joints at regular intervals not exceeding 12 feet in each direction. Decreasing the spacing of these joints will further reduce, but not eliminate the potential for unsightly cracking.

The above recommendations are based on the assumption that proper maintenance and irrigation of the areas adjacent to the pavement will occur through the design life of the pavement. Failure to maintain a proper maintenance and/or irrigation program may jeopardize the integrity of the pavement.

Earthwork recommendations regarding aggregate base and subgrade are provided in the previous Section "Site Earthwork" and the related sub-sections of this report.

**4.7 Corrosivity to Concrete and Metal**

Although not corrosion engineers (LGC Geotechnical is not a corrosion consultant), several governing agencies in Southern California require the geotechnical consultant to determine the corrosion potential of soils to buried concrete and metal facilities. We therefore present the results of our testing with regard to corrosion for the use of the client and other consultants, as they determine necessary.

Corrosion testing (soluble sulfate, chloride, pH and minimum resistivity) indicated soluble sulfate content values less than approximately 0.04 percent, chloride content values of 84 parts per million (ppm) and 81 ppm, pH values of 8.3 and 7.1, and minimum resistivity values of 1,685 ohm-cm and 1,098 ohm-cm. Previous corrosion testing indicates a soluble sulfate content less than 0.01 percent, chloride content of 33 ppm, pH of 8.2 and a minimum resistivity of 5,100 ohm-centimeters (Lawson, 2005). Based on Caltrans Corrosion Guidelines (2015), soils are considered corrosive if the pH is 5.5 or less, or the chloride concentration is 500 ppm or greater, or the sulfate concentration is 2,000 ppm (0.2 percent) or greater.

Based on laboratory sulfate test results, the near surface soils have a severity categorization of “Not Applicable” and are designated to a class “S0” per ACI 318, Table 4.2.1 with respect to sulfates. Concrete in direct contact with the onsite soils can be designed according to ACI 318, Section 4.3 using the “S0” sulfate classification.

**4.8 Nonstructural Concrete Flatwork**

Nonstructural concrete flatwork (such as walkways, bicycle trails, etc.) has a high potential for cracking due to changes in soil volume related to soil-moisture fluctuations. To reduce the potential for excessive cracking and lifting, concrete should be designed in accordance with the minimum guidelines outlined in Table 6. These guidelines will reduce the potential for irregular cracking and promote cracking along construction joints, but will not eliminate all cracking or lifting. Thickening the concrete and/or adding additional reinforcement will further reduce cosmetic distress.

**TABLE 6**

**Nonstructural Concrete Flatwork**

	<b>Flatwork</b>	<b>City Sidewalk Curb and Gutters</b>
<b>Minimum Thickness (in.)</b>	4	City/Agency Standard
<b>Presoaking</b>	Wet down prior to placing	City/Agency Standard
<b>Reinforcement</b>	No. 3 at 24 inches on centers	City/Agency Standard
<b>Crack Control Joints</b>	Saw cut or deep open tool joint to a minimum of $\frac{1}{3}$ the concrete thickness	City/Agency Standard
<b>Maximum Joint Spacing</b>	6 feet	City/Agency Standard
<b>Aggregate Base Thickness (in.)</b>	—	City/Agency Standard

**4.9 Subsurface Water Infiltration**

It should be noted that intentionally infiltrating storm water conflicts with the geotechnical engineering objective of directing surface water away from structures and improvements. The geotechnical stability and integrity of the project site is reliant upon appropriately handling all surface water.

Three locations of proposed storm water infiltration are depicted on the project plans (Thienes, 2018), essentially in the northern, southern and central portions of the site. Each would be in the upper flat area of the site, beneath the proposed parking lot. We understand that infiltration testing at these approximate locations has indicated rates suitable for storm water infiltration (Barto, 2017).

While the near surface soils may yield suitable rates for storm water infiltration, it is likely that the infiltration rates will decrease with depth, as the site materials become more dense. As the rate of infiltration slows, infiltrated water will likely spread laterally. Almost the entire eastern side of the site will be comprised of a descending slope with a Mechanically Stabilized Earth (MSE) retaining wall at the toe. Allowing infiltrated storm water to migrate to the location of descending slope and MSE retaining wall would reduce the stability of the slope and retaining wall, potentially leading to surficial and/or global failures.

Another concern with the proposed infiltration of storm water would be the potential for spread of the petroleum contamination from the site. We understand soil contamination has been identified in the northern portion of the site, associated the former transport of petroleum products across the site (SCS, 2017). Even though we understand that some remediation of the soil contamination is proposed, some contamination will also likely be left in place (SCS, 2017). Infiltration of storm water could result in migration of the contaminants to other parts of the site, as well as to adjacent properties. It should be noted that LGC Geotechnical is not an environmental consultant. Further discussion regarding the potential spread of the site contaminants should be directed to the site environmental consultant.

In general, the vast majority of geotechnical distress issues are directly related to improper drainage. In general, distress in the form of movement of improvements could occur as a result of soil saturation and loss of soil support, expansion, internal soil erosion, surficial and global slope failures, retaining wall failure, collapse and/or settlement. Infiltrated water may enter underground utility pipe zones and migrate along the pipe backfill, potentially impacting other improvements located far away from the point of infiltration.

Geotechnical stability and integrity of the project site is reliant upon appropriate handling of surface water. Due to the potential issues outlined herein, the intentional infiltration of storm water is not recommended.

#### **4.10 CIDH Pile Construction**

Boreholes for soldier piles should be plumb and free of loose or softened material. Extreme care in drilling, placement of reinforcement steel, and the pouring of concrete will be essential to avoid excessive disturbance of pile boring walls. The soldier pile steel section or reinforcing cage should be installed and the concrete pumped immediately after drilling is completed. Where applicable, concrete placement by pumping or tremie tube to the bottom of Cast-In-Drilled Hole (CIDH) excavations is recommended. No soldier pile borehole should be left open overnight. We recommend that pile borings not be drilled immediately adjacent to another pile until the concrete in the other pile has attained its initial set. A representative from LGC Geotechnical should be onsite during the drilling of piers to verify the assumptions made during the design stages.

The contractor should anticipate difficult drilling conditions. In addition, sandy soils are present at the site and these materials are generally susceptible to caving. Caving of drilled holes should be anticipated as caving sands were encountered in Boring LGC-BA-4, refer to the boring logs in Appendix B. Groundwater should be anticipated for any piers constructed below an approximate elevation of 10 feet above msl. The contractor should anticipate that any borehole left open for

any extended period of time will likely experience additional caving and potential groundwater conditions. Refer to the attached boring logs provided in Appendix B. If caving occurs during CIDH pile construction, a temporary casing may be required.

#### **4.11 Pre-Construction Monitoring**

It is recommended that a program of pre-construction documentation and monitoring be devised and put into practice before the onset of any groundwork.

The monitoring program should include, but not necessarily be limited to, detailed documentation of the existing improvements, structures and utilities around the site, with particular attention to any distress that is already present prior to the start of work.

#### **4.12 Geotechnical Plan Review**

Project plans (grading, retaining wall, etc.) should be reviewed by this office prior to construction to verify that our geotechnical recommendations have been incorporated. Additional or modified geotechnical recommendations may be required based on the proposed layout.

#### **4.13 Geotechnical Observation and Testing During Construction**

The recommendations provided in this report are based on limited subsurface observations and geotechnical analysis. The interpolated subsurface conditions should be checked in the field during construction by a representative of LGC Geotechnical. Geotechnical observation and testing is required per Section 1705 of the 2016 CBC and required by the City of Los Angeles Building Code.

Geotechnical observation and/or testing should be performed by the geotechnical consultant at the following stages:

- During grading (removal bottoms, fill placement, etc.);
- Drilling of pier boreholes and installation of lagging for soldier pile walls;
- Preparation of subgrade for MSE walls;
- During MSE retaining wall backfill and compaction;
- During backfill of utility trenches;
- Preparation of pavement subgrade and placement of aggregate base; and
- When any unusual soil conditions are encountered during any construction operation subsequent to issuance of this report.



## **5.0 RESPONSE TO CITY REVIEW COMMENTS**

### **Geology and Soils Report Review Letter Dated March 30, 2018**

For your convenience, the geology and soils review comments have been repeated below along with our responses. A copy of the review sheet is provided in Appendix F.

#### **Comment No. 1**

“Provide a complete and clear description of the proposed construction.”

#### **Response to Comment No. 1**

Based on the provided information, the proposed development will consist of a flat parking area for 18-wheel trucks and trailers, an access road, and associated utilities. Proposed grading will include retaining walls up to approximately 30 feet in height and fill slopes up to 45 feet in height (Thienes, 2018). It is our understanding that structures are not proposed for this development.

#### **Comment No. 2**

“It appears that the site is located on a City of Los Angeles Preliminary Fault Study Area. A fault investigation shall be conducted in accordance with guidelines presented in P/BC 2017-129.”

#### **Response to Comment No. 2**

A fault evaluation was not performed because the proposed development does not include the construction of proposed buildings. The proposed development is for a large parking lot and access road. The only proposed structures on the site are proposed retaining walls and cellular towers. According to the City information bulletin regarding Exemptions from Liquefaction, Earthquake Induced Landslide, and Fault-Rupture Hazard Zone Investigations (LADBS, 2018), the site is exempted from investigations in Alquist-Priolo Fault Study Zones or City of Los Angeles Preliminary Fault Rupture Study Areas. The project falls under exemption category 4: “Structures of Group U occupancy, including private garages, carports, retaining walls, fences, cell phone towers, etc.” (LADBS, 2018).

#### **Comment No. 3**

“The current consultants state in their update letter that additional geotechnical evaluation and analysis should be performed to address the new areas of the site. Provide a complete stand-alone geology/soils report for the proposed construction. Note: The previous reports are over 10 years old are not per current 2017 Los Angeles Building Code and according to the consultants the previous company is no longer in business. Also, incorporate the findings of the recent 05/18/2017 report into the requested report, as appropriate.”

**Response to Comment No. 3**

Included herein is a complete stand-alone geology/soils report with additional geotechnical evaluation and analysis addressing the new areas of the site. Appropriate data from the previous site reports has been considered and presented in this report.

**Comment No. 4**

“Identify all non-conforming conditions and provide recommendations to bring the entire site into conformance with the current Code standard (7005.9). Provide recommendations to remove and/or stabilize all landslide debris onsite.”

“Note: Current Code standard shall include but not be limited to removal and/or support of all existing non-conforming graded slopes and, underpinning/replacement of all existing foundations where not in conformance with current Code standards. Please be aware that all existing graded slopes steeper than 2H:1V will be considered as non-conforming.

**Response to Comment No. 4**

Our recommendations bring the geotechnical aspects of the project into conformance with the current Code standard (7005.9) and are provided in the recommendations section of this report.

**Comment No. 5**

“Where the consultants will be relying on data from previous consultants, the consultants shall provide a statement that referenced previous reports were reviewed, that they either concur with or do not concur with the findings contained therein, and that they will accept professional responsibility for the use of any data from others.”

**Response to Comment No. 5**

LGC Geotechnical has reviewed the referenced reports (Lawson, 2005, 2007a & 2007b) and accepts professional responsibility for the use of the geotechnical data provided from them. Our updated geotechnical recommendations based on the current development and the 2017 City of Los Angeles Building Code are provided herein.

**Comment No. 6**

“No map was provided with the current update report reflecting the proposed site conditions. Provide recommendations and revise the plan(s) and cross sections(s) for providing the required building setback from the toe of the ascending slope as specified by Code Section 1808.7.1.”

**Response to Comment No. 6**

Refer to the attached Geotechnical Map (Sheets 1 through 3). No building structures are planned for the site.

**Comment No. 7**

“Provide a geologic map and cross sections that are based upon conceptual grading or site development plans, to illustrate all proposed and existing contours relative to the planned grading and/or construction, along with all off-site slopes and conditions that could adversely affect the stability or safety of the site (7006.3.2). The geologic map and cross sections shall depict the top and bottom of slopes; lithologic contacts; bedding attitudes; locations of slumps, landslides, or faults relative to the subject site; existing and proposed topographic profiles; existing and proposed structures; and, required Code setbacks. (7006.3.2)”

**Response to Comment No. 7**

Refer to the attached Geotechnical Map and Geotechnical Cross Sections (Sheets 1 through 5). No building structures are planned for the site.

**Comment No. 8**

“Provide geological cross sections illustrating existing and proposed grades and structures through the highest, steepest and geologically critical slopes.”

**Response to Comment No. 8**

Refer to the attached Geotechnical Cross Sections (Sheets 4 and 5).

**Comment No. 9**

“Provide additional deep exploration with visual inspection by the geologist to verify the depth and extent of the landslide, confirm or rule-out the presence of any shears, slide planes, weak layers etc. and to perform sampling and laboratory testing of such features/earth materials.”

**Response to Comment No. 9**

Refer to the attached large-diameter boring logs (Appendix B).

**Comment No. 10**

“Provide a table summarizing all available strength values for along bedding and cross bedding; landslide debris; and, any other earth materials from the researched reports. Also indicate the values selected by the consultant.”

**Response to Comment No. 10**

Refer to the soil shear strength discussion provided in Section 2.8 and laboratory test results provided in Appendix C.

**Comment No. 11**

“Revise static and seismic slope stability analyses to consider both planar and circular potential failure planes, the weakest material profile, and the critical geologic cross sections.”

**Response to Comment No. 11**

Refer to the attached slope stability analysis (Appendix D).

**Comment No. 12**

“The pseudo-static load of 0.15 g does not appear to be in conformance with current code. Revise the pseudo-static slope stability analysis to be in conformance with the most recent version of CGS Special Publication 117 (i.e. SP 117A), Guidelines for Evaluating and Mitigating Seismic Hazards in California (1803.7.2), and with the Department guidelines presented in the Memorandum dated 07/16/2014 in the event the consultant does not have the memorandum, the reviewers could be contacted to send it via email). Notes (1) Ground motions used to evaluate liquefaction or slope stability shall be obtained based on methods prescribed in the 2017 LABC (refer to 1803.5.12). Ground shaking hazard maps found in the previous Seismic Hazard Zone Reports shall no longer be used to estimate ground shaking. The predominant earthquake magnitude-distance pair may be obtained from the USGS Interactive Deaggregation web site: <https://earthquake.usgs.gov/hazards/interactive/>. (2) The seismic coefficient,  $k_{eq}$ , shall be derived based on a displacement of 5 cm where critical slip surfaces intersect stiff improvements, such as buildings or pools, otherwise a maximum displacement of 15 cm may be assumed. (3) A minimum safety factor of 1.0 is required.”

**Response to Comment No. 12**

Seismic slope stability has been updated to reflect current guidelines, refer to Section 2.8 and Appendix D of this report.

**Comment No. 13**

“Provide seismic design parameters in accordance with current requirement in the 2017 Los Angeles Building Code.”

**Response to Comment No. 13**

Seismic parameters per the 2016 CBC/2017 Los Angeles are provided herein (Refer to Section 2.7).

**Comment No. 14**

“Provide retaining wall/basement design calculations and recommendations for lateral earth pressure due to earthquake motions for walls higher than 6 feet, as required by Section 1803.5.12 of the 2017 Los Angeles Building Code.”

“Note: The Department requires that the acceleration to be applied to the retained mass not be less than  $\frac{1}{2}$  of  $\frac{2}{3}$  the PGAM (Maximum Considered Earthquake-Geometric Mean, MCEG peak ground acceleration adjusted for Site Class effects, ASCE 7-10 Eq. 11.8-1).”

**Response to Comment No. 14**

Seismic lateral earth pressures for top-down constructed soldier pile walls per the 2016 CBC/2017 Los Angeles are provided herein (Refer to Section 4.3). The requested calculations are provided in Appendix D.

## **6.0 LIMITATIONS**

Our services were performed using the degree of care and skill ordinarily exercised, under similar circumstances, by reputable engineers and geologists practicing in this or similar localities. No other warranty, expressed or implied, is made as to the conclusions and professional advice included in this report. The samples taken and submitted for laboratory testing, the observations made and the in-situ field testing performed are believed representative of the entire project; however, soil and geologic conditions revealed by excavation may be different than our preliminary findings. If this occurs, the changed conditions must be evaluated by the project soils engineer and geologist and design(s) adjusted as required or alternate design(s) recommended.

This report is issued with the understanding that it is the responsibility of the owner, or of his/her representative, to ensure that the information and recommendations contained herein are brought to the attention of the designer and/or project engineer and incorporated into the plans, and the necessary steps are taken to see that the contractor and/or subcontractor properly implements the recommendations in the field. The contractor and/or subcontractor should notify the owner if they consider any of the recommendations presented herein to be unsafe.

The findings of this report are valid as of the present date. However, changes in the conditions of a property can and do occur with the passage of time, whether they be due to natural processes or the works of man on this or adjacent properties. Therefore, the findings, conclusions, and recommendations presented in this report can be relied upon only if LGC Geotechnical has the opportunity to observe the subsurface conditions during grading and construction of the project, in order to confirm that our preliminary findings are representative for the site.

In addition, changes in applicable or appropriate standards may occur, whether they result from legislation or the broadening of knowledge. Accordingly, the findings of this report may be invalidated wholly or partially by changes outside our control. Therefore, this report is subject to review and modification, and should not be relied upon after a period of 3 years.

*Appendix A*  
*References*

## APPENDIX A

### References

- American Concrete Institute, 2013, Guide for the Design and Construction of Concrete Parking Lots (ACI 330R-08), fifteenth printing, November 2013.
- \_\_\_\_\_, 2014, Building Code Requirements for Structural Concrete (ACI 318-14) and Commentary (ACI 318R-14).
- American Society of Civil Engineers (ASCE), 2013, Minimum Design Loads for Buildings and Other Structures, ASCE/SEI 7-10, Third Printing, 2013.
- California Building Standards Commission, 2016, California Building Code, California Code of Regulations Title 24, Volumes 1 and 2, dated July 2016.
- United States Geological Survey (USGS), 2008, Unified Hazard Tool, Dynamic: Conterminous U.S. 2008 (v3.3.1), Retrieved February 21, 2018, from: <https://earthquake.usgs.gov/hazards/interactive/>
- \_\_\_\_\_, 2018, U.S. Seismic Design Maps, Retrieved February 21, 2018, from: <http://geohazards.usgs.gov/designmaps/us/batch.php#csv>
- California Division of Mines and Geology (CDMG), 1998, Seismic Hazard Evaluation of the Torrance 7.5 Minute Quadrangle, Los Angeles, County, California, CDMG Open-File Report 98-26.
- California Geological Survey (CGS) (Previously California Division of Mines and Geology [CDMG]), 1986, State of California Special Studies Zones, Torrance Quadrangle, Official Map, effective July, 1986.
- \_\_\_\_\_, 1998, Seismic Hazard Evaluation of the Torrance 7.5-Minute Quadrangle, Los Angeles County, California, Open-File Report 98-26, dated 1998.
- \_\_\_\_\_, 1999, Seismic Hazard Zones, Torrance Quadrangle, Official Map, dated March 25, 1999.
- \_\_\_\_\_, 2010, California Geological Survey website, Interactive Fault Map: <http://www.quake.ca.gov/gmaps/FAM/faultactivitymap.html>
- \_\_\_\_\_, 2016, Geologic Map of the Long Beach 30' x 60' Quadrangle, California, Version 2.0.
- \_\_\_\_\_, 2018a, Earthquake Fault Zones, Special Publication 42, Revised 2018.
- \_\_\_\_\_, 2018b, Earthquake Zones of Required Investigation, Torrance Quadrangle, released February 7, 2018.
- California Emergency Management Agency, California Geologic Survey, University of Southern California, 2009, Tsunami Inundation Map for Emergency Planning, Torrance Quadrangle/San Pedro Quadrangle, Scale 1:24,000, dated March 1, 2009.



*APPENDIX A (Cont'd)*

*References*

- City of Los Angeles (City), 2018, Geology and Soils Report Review Letter, Log # 102389, dated March 30, 2018.
- Federal Highway Administration (FHA), 2011, LRFD Seismic Analysis and Design of Transportation Geotechnical Features and Structural Foundation, Reference Manual, Publication No. FHWA-11-032, August, 2011.
- Gregory Geotechnical Software, 2013, GSTABL7, Version 2.005.3, March.
- Lawson and Associates Geotechnical Consulting, Inc., (Lawson) 2005, Preliminary Geotechnical Investigation for Proposed Self-Storage Facility, San Pedro, California, Project No. 041104-01, dated January 27, 2005.
- \_\_\_\_\_, 2007a, Supplemental Geotechnical Investigation, San Pedro Storage/Industrial Project, John S. Gibson Boulevard, San Pedro, California, Project No. 041104-01, dated July 19, 2007.
- \_\_\_\_\_, 2007b, Response to Geotechnical Review Comments, Preliminary Geotechnical Investigation, San Pedro Storage/Industrial Project, John S. Gibson Boulevard, San Pedro, California, Project No. 041104-01, dated July 20, 2007
- Lew, et al, 2010, Seismic Earth Pressures on Deep Basements, Structural Engineers Association of California (SEAOC) Convention Proceedings.
- Los Angeles Department of Building and Safety (LADBS), 2014, Preliminary LA Fault Study Zones and Alquist-Priolo Earthquake Fault Zones Map, City of Los Angeles, dated December 18, 2014.
- \_\_\_\_\_, 2015, Special Instruction Memorandum, City of Los Angeles Preliminary Fault Rupture Study Areas, dated July 7, 2015.
- \_\_\_\_\_, 2017, Soils/Geology Report Requirements when Filing a Parcel Map or Tract Map Application with the Department of City Planning, Information Bulletin/Public – Building Code, Reference No.: LABC 1803, 7006.2, Document No.: P/BC 2017-132, effective January 1, 2017.
- \_\_\_\_\_, 2018, Exemptions from Liquefaction, Earthquake Induced Landslide, and Fault-Rupture Hazard Zone Investigations, Information Bulletin/Public – Building Code, Reference No.: LABC 1613.3 & 1803.5, Document No.: P/BC 2017-044, effective January 1, 2017, revised September 16, 2018.
- Ron Barto Ground Water Consultant (Barto), 2017, Report on Double Ring Infiltration Testing for the Proposed Port of Los Angeles Fueling Station Located along John S. Gibson Blvd North of W Channel Street, San Pedro, CA, Report 1400, dated May 18, 2017.
- SCS Engineer, 2017, Phase II Site Investigation Report, Approximately 19.65-acre Site Located Northwest of John S. Gibson Boulevard, San Pedro, California 90731 (APNS: 7440-016-001 and Portions of 7412-024-902, -907, & -911), File No. 0121765.00, Task 3, dated August 25, 2017.

*APPENDIX A (Cont'd)*

**References**

- Stark T.D., Choi, H., and McCone, S., 2005, Drained shear strength parameters for analysis of landslides, *Journal of Geotechnical and Geoenvironmental Engineering*, ASCE, pp. 575-588, dated May 2005.
- Stark, T.D., Hussain, M., 2013, Empirical Correlations: Drained shear strength for slope stability analysis, *Journal of Geotechnical and Geoenvironmental Engineering*, ASCE, pp. 853-862, dated June 2013.
- Thienes Engineering. Inc. (Thienes), 2018, Precise Grading Plan, San Pedro Distribution Center, Los Angeles, California, dated November 27, 2018.
- Treiman, J.A., Lundberg, M., and Bryant, W.A., compilers, 2017, Fault number 128b, Palos Verdes fault zone, Palos Verdes Hills section, in Quaternary fault and fold database of the United States: U.S. Geological Survey website, <https://earthquakes.usgs.gov/hazards/qfaults>, accessed January 14, 2019.
- United States Geological Survey (USGS), 2008, Unified Hazard Tool, Dynamic: Conterminous U.S. 2008 (v3.3.1), Retrieved February 21, 2018, from: <https://earthquake.usgs.gov/hazards/interactive/>
- \_\_\_\_\_, 2018, U.S. Seismic Design Maps, Retrieved February 21, 2018, from: <http://geohazards.usgs.gov/designmaps/us/batch.php#csv>

*Appendix B*  
*Boring & CPT Logs*

# Geotechnical Boring Log LGC-BA-1

Date : 8/10/2017	Page 1 of 3	Drilling Company : Al Roy Drilling
Project Name : John S Gibson Blvd	Type of Rig : EZ Bore	
Project Number : 12091-01	Drop : 12"	Hole Diameter : 26"
Elevation of Top of Hole : ~ 85' MSL	Drive Weight : #4800, 0 to 24'; #3350, 25' to 58'; #2045, 59' to 86'; #1200, 87' to 115'	
Hole Location : See Geotechnical Map		

Logged by KTM  
Sampled by KTM

Elevation (ft)	Depth (ft)	Graphic Log	Attitudes	Sample Number	Blow Count	Dry Density(pcf)	Moisture (%)	USCS Symbol	DESCRIPTION	Type of Test	
80	0							SM	<p><b>@ 0' to T.D. Quaternary Older Marine Terrace Deposits (Qom):</b>                      @0' Silty SANDSTONE: mottled light reddish brown, slightly moist, dense to very dense; desiccated and weathered; arkosic fine sand; moderately indurated; krotovina                      @ 2' SANDSTONE with Silt: decrease in weathering; faint subhorizontal stratification; iron oxide</p> <p>@ 6' SANDSTONE with trace Silt: yellowish brown, slightly moist to moist; friable; calcite; few iron oxide bands</p> <p>@ 10' Silty SANDSTONE: mottled yellowish brown, moist, medium dense; subhorizontal lenses with calcite; variable iron oxide banding; clayey siltstone rip-up clasts; partially lithified; vague bedding; friable sand between rip-up clasts</p> <p>@ 14' Scour/ rip-up contact. Below is Clayey SILTSTONE with Sand</p> <p>@ 15' General bedding attitude. Variably white mineralization; soft sediment deformation; grades to sandstone.</p> <p>@ 19' Bedding attitude on moderately red sand lens; cross bedding; thickness varies                      @ 20' Fine SANDSTONE with trace Silt: light gray and light orange banded, moist, medium dense; iron oxide banded; friable</p> <p>@ 22' Bedding attitude on Silty CLAY: gray, continuous; approximately 1/8" thick; faintly sheared; slightly undulatory. Below is interbedded orange SANDSTONE and gray SILTSTONE: moist, dense to very dense and stiff</p> <p>@ 27' Bedding attitude.</p> <p>@ 29' Bedding attitude. Below is Clayey SILTSTONE with trace fine Sand: yellowish brown, very moist, very stiff</p>		
75	5		B-1					SP		MD AL S&H CR	
75	10				R-1	4		SM		#200	
70	15		GB: N10W, 10W								
65	20		B: N45W, 10SW		R-2	4					
60	25		B: N85W, 13N								
			B: N31W, 4N								
			B: N25W, 7NE								
										ML	



THIS SUMMARY APPLIES ONLY AT THE LOCATION OF THIS BORING AND AT THE TIME OF DRILLING. SUBSURFACE CONDITIONS MAY DIFFER AT OTHER LOCATIONS AND MAY CHANGE AT THIS LOCATION WITH THE PASSAGE OF TIME. THE DATA PRESENTED IS A SIMPLIFICATION OF THE ACTUAL CONDITIONS ENCOUNTERED.

<b>SAMPLE TYPES:</b> B BULK SAMPLE R RING SAMPLE G GRAB SAMPLE	<b>TEST TYPES:</b> DS DIRECT SHEAR MD MAXIMUM DENSITY SA SIEVE ANALYSIS S&H SIEVE AND HYDROMETER EI EXPANSION INDEX CN CONSOLIDATION CR CORROSION AL ATTERBERG LIMITS CO COLLAPSE/SWELL RV R-VALUE
---	--

Last Edited: 8/28/2017

# Geotechnical Boring Log LGC-BA-1

Date : 8/10/2017	Page 2 of 3	Drilling Company : Al Roy Drilling
Project Name : John S Gibson Blvd	Type of Rig : EZ Bore	
Project Number : 12091-01	Drop : 12"	Hole Diameter : 26"
Elevation of Top of Hole : ~ 85' MSL	Drive Weight : #4800, 0 to 24'; #3350, 25' to 58'; #2045, 59' to 86'; #1200, 87' to 115'	
Hole Location : See Geotechnical Map		

Elevation (ft)	Depth (ft)	Graphic Log	Attitudes	Sample Number	Blow Count	Dry Density(pcf)	Moisture (%)	USCS Symbol	DESCRIPTION	Type of Test
	30			R-3	3			ML	@ 30' Clayey SILTSTONE with some Sand lenses: moderately yellowish brown, moist, very stiff; iron oxide lined fractures	AL
	50							SP	@ 35' SANDSTONE with Siltstone rip-up clasts: reddish orange, very moist, moderately dense grades to fine SANDSTONE with trace Silt: reddish brown, moist, dense; massive; friable	
	45			R-4	6			SP-ML	@ 40' SANDSTONE with interbedded SILT with Clay: light yellowish brown, moist to very moist, dense; iron oxide banding; friable, minor bellling	
	40									
	35			R-5	6			SP	@ 50' Fine SANDSTONE with trace Silt: light yellowish brown to light gray, very moist, dense	
	30								@ 55' Shells present; few iron oxide nodules	
									@ 58' SANDSTONE with Silt: yellowish brown, very moist, dense; shells present; partially cemented	



THIS SUMMARY APPLIES ONLY AT THE LOCATION OF THIS BORING AND AT THE TIME OF DRILLING. SUBSURFACE CONDITIONS MAY DIFFER AT OTHER LOCATIONS AND MAY CHANGE AT THIS LOCATION WITH THE PASSAGE OF TIME. THE DATA PRESENTED IS A SIMPLIFICATION OF THE ACTUAL CONDITIONS ENCOUNTERED.

**SAMPLE TYPES:**  
 B BULK SAMPLE  
 R RING SAMPLE  
 G GRAB SAMPLE

**TEST TYPES:**  
 DS DIRECT SHEAR  
 MD MAXIMUM DENSITY  
 SA SIEVE ANALYSIS  
 S&H SIEVE AND HYDROMETER  
 EI EXPANSION INDEX  
 CN CONSOLIDATION  
 CR CORROSION  
 AL ATTERBERG LIMITS  
 CO COLLAPSE/SWELL  
 RV R-VALUE

# Geotechnical Boring Log LGC-BA-1

Date : 8/10/2017	Page 3 of 3	Drilling Company : Al Roy Drilling
Project Name : John S Gibson Blvd	Type of Rig : EZ Bore	
Project Number : 12091-01	Drop : 12"	Hole Diameter : 26"
Elevation of Top of Hole : ~ 85' MSL	Drive Weight : #4800, 0 to 24'; #3350, 25' to 58'; #2045, 59' to 86'; #1200, 87' to 115'	
Hole Location : See Geotechnical Map		

Elevation (ft)	Depth (ft)	Graphic Log	Attitudes	Sample Number	Blow Count	Dry Density(pcf)	Moisture (%)	USCS Symbol	DESCRIPTION	Type of Test
	60			R-6	10			SP	@ 60' Fine SANDSTONE with some Silt: very moist, dense; iron oxide; micaceous; shells present; increase moisture with depth	
20	65								@ 68' End visual log	
15	70				R-7	15			@ 70' Fine SANDSTONE with some Silt: very moist, dense; iron oxide; micaceous; shells present	
10	75								<b>Total Depth = 71.5'</b> <b>No Ground Water Encountered</b> <b>Backfilled with Cuttings on 8/10/2017</b>	
5	80									
0	85									



THIS SUMMARY APPLIES ONLY AT THE LOCATION OF THIS BORING AND AT THE TIME OF DRILLING. SUBSURFACE CONDITIONS MAY DIFFER AT OTHER LOCATIONS AND MAY CHANGE AT THIS LOCATION WITH THE PASSAGE OF TIME. THE DATA PRESENTED IS A SIMPLIFICATION OF THE ACTUAL CONDITIONS ENCOUNTERED.

**SAMPLE TYPES:**  
 B BULK SAMPLE  
 R RING SAMPLE  
 G GRAB SAMPLE

**TEST TYPES:**  
 DS DIRECT SHEAR  
 MD MAXIMUM DENSITY  
 SA SIEVE ANALYSIS  
 S&H SIEVE AND HYDROMETER  
 EI EXPANSION INDEX  
 CN CONSOLIDATION  
 CR CORROSION  
 AL ATTERBERG LIMITS  
 CO COLLAPSE/SWELL  
 RV R-VALUE

# Geotechnical Boring Log LGC-BA-2

Date : 8/14/2017	Page 1 of 2	Drilling Company : Al Roy Drilling
Project Name : John S Gibson Blvd	Type of Rig : EZ Bore	
Project Number : 12091-01	Drop : 12"	Hole Diameter : 26"
Elevation of Top of Hole : ~ 70' MSL	Drive Weight : #4800, 0 to 24'; #3350, 25' to 58'; #2045, 59' to 86'; #1200, 87' to 115'	
Hole Location : See Geotechnical Map		

Elevation (ft)	Depth (ft)	Graphic Log	Attitudes	Sample Number	Blow Count	Dry Density(pcf)	Moisture (%)	USCS Symbol	DESCRIPTION	Type of Test
0	0								<p>Logged by KTM Sampled by KTM</p> <p><b>@ 0' to 14' Quaternary Landslide Deposit (Qls):</b>                      @0' Silty fine SANDSTONE with SANDSTONE lenses: yellowish brown, slightly moist, moderately dense; iron oxide mottling; rootlets to approximately 2'</p> <p>@ 4' Offset Silty CLAY bed, approximately 1" thick. Blocks shifted, dense material</p> <p>@ 7' Bedding attitude, continuous</p> <p>ML @ 9' Bedding attitude on interbedded SILTSTONE and SANDSTONE; beds approximately 2" to 4" thick, iron oxide; manganese oxide</p> <p>SP @ 10' Fine SAND with Silt: yellowish brown, slightly moist, very dense</p> <p>@ 14' Rupture surface attitude. Very thin CLAY: gray with white mineral over charcoal; lens zone of clayey silt with powder-fine sand lenses</p> <p>ML-SM <b>@14' to T.D. Quaternary Older Marine Terrace Deposits (Qom):</b>                      @14' SILTSTONE with fine Sand to Silty SANDSTONE: moderately reddish brown, very moist, slightly hard; thinly to moderately bedded; iron oxide nodules                      @ 16' Bedding attitude on SANDSTONE with Silty CLAY interbeds; slightly undulatory</p> <p>ML @ 20' Clayey SILTSTONE with trace very fine Sand lenses: olive gray with orange mottling, moist, very stiff</p> <p>@ 23' Induration or cementation zone. Slightly chippy, over sandstone</p> <p>@ 24' SANDSTONE: reddish brown with gray mottling; fine grained with medium grained rip ups lined with iron oxide</p>	
65	5		B: N75W, 7N	B-1						AL
60	10		B: N45W, 10NE	R-1	15/10"					#200
55	15		RS: N12E, 10E	GB-2						AL
			B: N28W, 4NE							
50	20			R-2	6					
45	25									

Last Edited: 8/28/2017



THIS SUMMARY APPLIES ONLY AT THE LOCATION OF THIS BORING AND AT THE TIME OF DRILLING. SUBSURFACE CONDITIONS MAY DIFFER AT OTHER LOCATIONS AND MAY CHANGE AT THIS LOCATION WITH THE PASSAGE OF TIME. THE DATA PRESENTED IS A SIMPLIFICATION OF THE ACTUAL CONDITIONS ENCOUNTERED.

**SAMPLE TYPES:**  
 B BULK SAMPLE  
 R RING SAMPLE  
 G GRAB SAMPLE

**TEST TYPES:**  
 DS DIRECT SHEAR  
 MD MAXIMUM DENSITY  
 SA SIEVE ANALYSIS  
 S&H SIEVE AND HYDROMETER  
 EI EXPANSION INDEX  
 CN CONSOLIDATION  
 CR CORROSION  
 AL ATTERBERG LIMITS  
 CO COLLAPSE/SWELL  
 RV R-VALUE

# Geotechnical Boring Log LGC-BA-2

Date : 8/14/2017	Page 2 of 2	Drilling Company : Al Roy Drilling
Project Name : John S Gibson Blvd	Type of Rig : EZ Bore	
Project Number : 12091-01	Drop : 12"	Hole Diameter : 26"
Elevation of Top of Hole : ~ 70' MSL	Drive Weight : #4800, 0 to 24'; #3350, 25' to 58'; #2045, 59' to 86'; #1200, 87' to 115'	
Hole Location : See Geotechnical Map		

Elevation (ft)	Depth (ft)	Graphic Log	Attitudes	Sample Number	Blow Count	Dry Density(pcf)	Moisture (%)	USCS Symbol	DESCRIPTION	Type of Test
30			B: N15E, 10E	R-3	30/10"			SP	Logged by KTM Sampled by KTM  @ 30' SANDSTONE with trace Silt: yellowish brown, very moist, very dense; iron oxide; well indurated; lacks cementation @ 31' SANDSTONE with few, scattered, very thin Silt lenses: light brown, very moist, dense; friable; slight belling; iron oxide banding; lacks cementation  @ 35' SANDSTONE with trace Silt: yellowish brown, very moist, very dense; iron oxide; well indurated; lacks cementation  @ 43' Bedding attitude on very thin faint clayey lenses with iron oxide halo  @ 45' Fine SANDSTONE with variable SILT (trace to some): light yellowish brown, very moist, dense to very dense; lacks cementation; friable; belling; shells present  @ 52' End visual log  @ 55' Clayey SILTSTONE with trace fine Sand: light olive brown, very moist, few iron oxide fleck/lines  <b>Total Depth = 56.5'</b> <b>No Ground Water Encountered</b> <b>Backfilled with Cuttings on 8/14/2017</b>	
35				R-4	30/6"					
40				R-5	30/10"					
45				R-6	50/7"					ML
50										
55										



THIS SUMMARY APPLIES ONLY AT THE LOCATION OF THIS BORING AND AT THE TIME OF DRILLING. SUBSURFACE CONDITIONS MAY DIFFER AT OTHER LOCATIONS AND MAY CHANGE AT THIS LOCATION WITH THE PASSAGE OF TIME. THE DATA PRESENTED IS A SIMPLIFICATION OF THE ACTUAL CONDITIONS ENCOUNTERED.

**SAMPLE TYPES:**  
 B BULK SAMPLE  
 R RING SAMPLE  
 G GRAB SAMPLE

**TEST TYPES:**  
 DS DIRECT SHEAR  
 MD MAXIMUM DENSITY  
 SA SIEVE ANALYSIS  
 S&H SIEVE AND HYDROMETER  
 EI EXPANSION INDEX  
 CN CONSOLIDATION  
 CR CORROSION  
 AL ATTERBERG LIMITS  
 CO COLLAPSE/SWELL  
 RV R-VALUE



# Geotechnical Boring Log LGC-BA-3

Date : 12/11/2018	Page 1 of 3	Drilling Company : Al Roy Drilling
Project Name : John S Gibson Blvd	Type of Rig : Earthdrill	
Project Number : 12091-01	Drop : 12"	Hole Diameter : 26"
Elevation of Top of Hole : ~ 84' MSL	Drive Weight : #2400, 0' to 23'; #1550, 24' to 43'; #850, 43' to 62'	
Hole Location : See Geotechnical Map		

Logged by KTM  
Sampled by CNJ

Elevation (ft)	Depth (ft)	Graphic Log	Attitudes	Sample Number	Blow Count	Dry Density(pcf)	Moisture (%)	USCS Symbol	DESCRIPTION	Type of Test
0	0								<p><b>@ 0' to 13.5' Undocumented Artificial Fill (afu)</b>                      @ 0' SAND over asphalt concrete, 3" thick, over layers of SAND with Silt and Clay, dark brown and gray mottled, moist, medium dense; debris; roots; clasts of coquina                      @ 2.5' Silty SAND: reddish brown and brown mottled, dry to slightly moist, dense; asphalt pieces up to 5" in diameter</p>	MD CR S&H
80	5			B-1					<p>@ 6' SAND with Silty SAND lenses: light brown, dry to slightly moist, medium dense; friable; lifts up to 1' thick visible</p>	
75	10			R-1	3	104.8	5.7	SM	<p>@ 10' SAND with Silt: light brown, slightly moist, medium dense; small sand sized shell fragments; concrete pieces</p>	#200 AL
70	15								<p>@ 13.5' Layer of concrete and plastic debris  <b>@13.5' to T.D. Quaternary Old Marine Deposits (Qom)</b>                      @ 13.5' SANDSTONE with Silt: light yellowish brown to light brown, moist, medium dense to dense; slightly friable; iron oxide staining</p>	
65	20		B: N50W, 3S						<p>@ 18' Bedding attitude on Clayey SILT lens, 1 to 2" thick; thinly laminated zone with calcium carbonate blebs; iron oxide laminations</p>	
60	25		GB: N50W, 5S	R-2	10/10"	87.8	8.1	SP	<p>@ 20' SANDSTONE: light gray brown, moist, dense; micaceous; friable; trace iron oxide</p>	
55									<p>@ 22' General bedding attitude on fine sandy laminations in interbedded sandstone and siltstone</p> <p>@ 25' SANDSTONE: light brown, slightly moist; very friable</p>	



THIS SUMMARY APPLIES ONLY AT THE LOCATION OF THIS BORING AND AT THE TIME OF DRILLING. SUBSURFACE CONDITIONS MAY DIFFER AT OTHER LOCATIONS AND MAY CHANGE AT THIS LOCATION WITH THE PASSAGE OF TIME. THE DATA PRESENTED IS A SIMPLIFICATION OF THE ACTUAL CONDITIONS ENCOUNTERED.

<b>SAMPLE TYPES:</b>	<b>TEST TYPES:</b>
B BULK SAMPLE	DS DIRECT SHEAR
R RING SAMPLE	MD MAXIMUM DENSITY
G GRAB SAMPLE	SA SIEVE ANALYSIS
	S&H SIEVE AND HYDROMETER
	EI EXPANSION INDEX
	CN CONSOLIDATION
	CR CORROSION
	AL ATTERBERG LIMITS
	CO COLLAPSE/SWELL
	RV R-VALUE

# Geotechnical Boring Log LGC-BA-3

Date : 12/11/2018	Page 2 of 3	Drilling Company : Al Roy Drilling
Project Name : John S Gibson Blvd	Type of Rig : Earthdrill	
Project Number : 12091-01	Drop : 12"	Hole Diameter : 26"
Elevation of Top of Hole : ~ 84' MSL	Drive Weight : #2400, 0' to 23'; #1550, 24' to 43'; #850, 43' to 62'	
Hole Location : See Geotechnical Map		

Logged by KTM  
Sampled by CNJ

## DESCRIPTION

Elevation (ft)	Depth (ft)	Graphic Log	Attitudes	Sample Number	Blow Count	Dry Density(pcf)	Moisture (%)	USCS Symbol	DESCRIPTION	Type of Test	
30				R-3	25	104.8	7.4	SP	@ 30' SANDSTONE: very light brown, light gray, and orange mottled, moist, dense; micaceous; iron oxide; friable; clay with sand bed up to 1/2" thick		
50			GB: N40E, 4S						@ 35' General bedding attitude on yellowish brown claystone bed, 3" thick, slightly undulatory, coquina bed below. Sandy SILTSTONE below.		
45					R-4	25	98.9	25.5	CL-ML	@ 39' SANDSTONE with iron oxide laminations, moist, medium dense; variable cementation; friable to moderately cemented @ 40' Clayey SILTSTONE with Sand: grayish brown, very moist, very stiff; iron oxide; micaceous	DS #200
40				B: N45E, 10S						@ 45' Decrease moisture to moist @ 46' Bedding attitude. Faintly crossbedded silt and sand lenses with iron oxide laminations	
35				B: N54E, 12S	R-5	50/7"	89.2	24.5	SC	@ 50' Bedding attitude. SANDSTONE with Silt and Clay lenses: light gray brown with orange mottling, very moist, dense; abundant iron oxide; bedding offset approximately 4"; soft sediment deformation ; thinly interbedded; crossbedding	
30									@ 56' SILTSTONE: brown to dark gray with depth, very moist, very stiff; iron oxide		
25											



THIS SUMMARY APPLIES ONLY AT THE LOCATION OF THIS BORING AND AT THE TIME OF DRILLING. SUBSURFACE CONDITIONS MAY DIFFER AT OTHER LOCATIONS AND MAY CHANGE AT THIS LOCATION WITH THE PASSAGE OF TIME. THE DATA PRESENTED IS A SIMPLIFICATION OF THE ACTUAL CONDITIONS ENCOUNTERED.

**SAMPLE TYPES:**  
 B BULK SAMPLE  
 R RING SAMPLE  
 G GRAB SAMPLE

**TEST TYPES:**  
 DS DIRECT SHEAR  
 MD MAXIMUM DENSITY  
 SA SIEVE ANALYSIS  
 S&H SIEVE AND HYDROMETER  
 EI EXPANSION INDEX  
 CN CONSOLIDATION  
 CR CORROSION  
 AL ATTERBERG LIMITS  
 CO COLLAPSE/SWELL  
 RV R-VALUE

# Geotechnical Boring Log LGC-BA-3

Date : 12/11/2018	Page 3 of 3	Drilling Company : Al Roy Drilling
Project Name : John S Gibson Blvd	Type of Rig : Earthdrill	
Project Number : 12091-01	Drop : 12"	Hole Diameter : 26"
Elevation of Top of Hole : ~ 84 ' MSL	Drive Weight : #2400, 0' to 23'; #1550, 24' to 43'; #850, 43' to 62'	
Hole Location : See Geotechnical Map		

Elevation (ft)	Depth (ft)	Graphic Log	Attitudes	Sample Number	Blow Count	Dry Density(pcf)	Moisture (%)	USCS Symbol	DESCRIPTION	Type of Test
	60		GB: N20E, 5N	R-6	50/5"	106.1	21.4	ML/CL	@ 60' SILT and CLAY with Sand; olive brown, very moist, hard; iron oxide nodules; very degraded/remnant organics; micaceous	
	20								@ 62.5' General bedding attitude. Contact with red brown sandstone below. Gray clayey rip-up clasts, moist, dense; slightly friable; massive sand grades to light reddish brown; increase moisture to very moist with depth	
	65								@ 68' End visual log.	
	70								<b>Total Depth = 70'</b> <b>No Ground Water Encountered</b> <b>Backfilled with Cuttings on 12/11/2018</b>	
	75									
	80									
	85									
	-5									

	THIS SUMMARY APPLIES ONLY AT THE LOCATION OF THIS BORING AND AT THE TIME OF DRILLING. SUBSURFACE CONDITIONS MAY DIFFER AT OTHER LOCATIONS AND MAY CHANGE AT THIS LOCATION WITH THE PASSAGE OF TIME. THE DATA PRESENTED IS A SIMPLIFICATION OF THE ACTUAL CONDITIONS ENCOUNTERED.	<table style="width: 100%; border: none;"> <tr> <td style="width: 50%; border: none;"><b>SAMPLE TYPES:</b></td> <td style="width: 50%; border: none;"><b>TEST TYPES:</b></td> </tr> <tr> <td style="border: none;">                     B BULK SAMPLE                      R RING SAMPLE                      G GRAB SAMPLE                 </td> <td style="border: none;">                     DS DIRECT SHEAR                      MD MAXIMUM DENSITY                      SA SIEVE ANALYSIS                      S&amp;H SIEVE AND HYDROMETER                      EI EXPANSION INDEX                      CN CONSOLIDATION                      CR CORROSION                      AL ATTERBERG LIMITS                      CO COLLAPSE/SWELL                      RV R-VALUE                 </td> </tr> </table>	<b>SAMPLE TYPES:</b>	<b>TEST TYPES:</b>	B BULK SAMPLE R RING SAMPLE G GRAB SAMPLE	DS DIRECT SHEAR MD MAXIMUM DENSITY SA SIEVE ANALYSIS S&H SIEVE AND HYDROMETER EI EXPANSION INDEX CN CONSOLIDATION CR CORROSION AL ATTERBERG LIMITS CO COLLAPSE/SWELL RV R-VALUE
<b>SAMPLE TYPES:</b>	<b>TEST TYPES:</b>					
B BULK SAMPLE R RING SAMPLE G GRAB SAMPLE	DS DIRECT SHEAR MD MAXIMUM DENSITY SA SIEVE ANALYSIS S&H SIEVE AND HYDROMETER EI EXPANSION INDEX CN CONSOLIDATION CR CORROSION AL ATTERBERG LIMITS CO COLLAPSE/SWELL RV R-VALUE					

# Geotechnical Boring Log LGC-BA-4

Date : 12/12/2018	Page 1 of 3	Drilling Company : Al Roy Drilling
Project Name : John S Gibson Blvd	Type of Rig : Earthdrill	
Project Number : 12091-01	Drop : 12"	Hole Diameter : 26"
Elevation of Top of Hole : ~ 70' MSL	Drive Weight : #2400, 0' to 23'; #1550, 24' to 43'; #850, 43' to 62'	
Hole Location : See Geotechnical Map		

Logged by KTM  
Sampled by KTM

Elevation (ft)	Depth (ft)	Graphic Log	Attitudes	Sample Number	Blow Count	Dry Density(pcf)	Moisture (%)	USCS Symbol	DESCRIPTION	Type of Test
65	5	B-1	GB: N59E, 5S	B-1					<p>@ 0' to 2.5' <b>Undocumented Artificial Fill (afu)</b></p> <p>@ 0' Asphalt concrete, 3" thick, over Sandy CLAY: dark reddish brown mottled, moist, stiff; rootlets</p> <p>@ 2' Sandy CLAY: brown, dry; asphalt pieces; few rootlets;</p> <p>@ 2.5' to T.D. <b>Quaternary Old Marine Deposits (Qom)</b></p> <p>@ 2.5' Topsoil, dry</p> <p>@ 4' Silty SANDSTONE: light reddish brown mottled, slightly moist, very dense; well-indurated; variable silt content; few rootlets</p> <p>@ 5' Krotovina, infilled rodent burrows</p> <p>@ 7.5' General bedding contact between SAND and Silty SAND</p> <p>@ 8' Very thin concretion lenses, possibly along bedding</p>	AL DS CR MD S&H
60	10	R-1	J: N38W, vert.	R-1	10/6"	112.0	6.1	SM	<p>@ 10' Silty SANDSTONE: light reddish brown to orangish brown, slightly moist, dense to very dense; very weakly cemented</p> <p>@ 11' Joint attitude; soft sediment deformation</p> <p>@ 14' End visual log due to caving conditions. Friable SANDSTONE below.</p>	DS #200
50	20	R-2		R-2	12	101.7	1.1	SP	<p>@ 20' SANDSTONE: light yellowish brown, dry to slightly moist, medium dense; friable; scattered small shells</p> <p>@ 25' Increase moisture to moist. Color varies with depth, light greenish yellow to light yellowish brown; slightly indurated</p> <p>@ 29' Increase shell fragments</p>	

Last Edited: 12/21/2018



THIS SUMMARY APPLIES ONLY AT THE LOCATION OF THIS BORING AND AT THE TIME OF DRILLING. SUBSURFACE CONDITIONS MAY DIFFER AT OTHER LOCATIONS AND MAY CHANGE AT THIS LOCATION WITH THE PASSAGE OF TIME. THE DATA PRESENTED IS A SIMPLIFICATION OF THE ACTUAL CONDITIONS ENCOUNTERED.

**SAMPLE TYPES:**  
 B BULK SAMPLE  
 R RING SAMPLE  
 G GRAB SAMPLE

**TEST TYPES:**  
 DS DIRECT SHEAR  
 MD MAXIMUM DENSITY  
 SA SIEVE ANALYSIS  
 S&H SIEVE AND HYDROMETER  
 EI EXPANSION INDEX  
 CN CONSOLIDATION  
 CR CORROSION  
 AL ATTERBERG LIMITS  
 CO COLLAPSE/SWELL  
 RV R-VALUE

# Geotechnical Boring Log LGC-BA-4

Date : 12/12/2018	Page 2 of 3	Drilling Company : Al Roy Drilling
Project Name : John S Gibson Blvd	Type of Rig : Earthdrill	
Project Number : 12091-01	Drop : 12"	Hole Diameter : 26"
Elevation of Top of Hole : ~ 70 ' MSL	Drive Weight : #2400, 0' to 23'; #1550, 24' to 43'; #850, 43' to 62'	
Hole Location : See Geotechnical Map		

Elevation (ft)	Depth (ft)	Graphic Log	Attitudes	Sample Number	Blow Count	Dry Density(pcf)	Moisture (%)	USCS Symbol	DESCRIPTION	Type of Test	
	30			R-3	21	109.3	3.0	SP	@ 30' SANDSTONE: light orangish brown, slightly moist, dense; shell fragments up to 1/2"; fine to medium sand with few coarse grains		
	35								@ 35' Increase moisture to very moist to wet, scattered shells up to 2" in diameter		
	30				R-4	30	105.8	2.9	SP	@ 40' SANDSTONE: light yellowish brown, slightly moist, dense to very dense; shell fragments	
	25									@ 45' SANDSTONE with Silt and Siltstone lenses/interbeds, increase induration, scattered shell fragments. Base of belled zone in borehole.	
	20				R-5	50/10"	103.2	9.7	SP-SM	@ 50' SANDSTONE with Silt: light greenish and yellowish brown, moist, dense; very few shell fragments	
	15										

	<p>THIS SUMMARY APPLIES ONLY AT THE LOCATION OF THIS BORING AND AT THE TIME OF DRILLING. SUBSURFACE CONDITIONS MAY DIFFER AT OTHER LOCATIONS AND MAY CHANGE AT THIS LOCATION WITH THE PASSAGE OF TIME. THE DATA PRESENTED IS A SIMPLIFICATION OF THE ACTUAL CONDITIONS ENCOUNTERED.</p>	<p><b>SAMPLE TYPES:</b>                  B BULK SAMPLE                  R RING SAMPLE                  G GRAB SAMPLE</p> <p><b>TEST TYPES:</b>                  DS DIRECT SHEAR                  MD MAXIMUM DENSITY                  SA SIEVE ANALYSIS                  S&amp;H SIEVE AND HYDROMETER                  EI EXPANSION INDEX                  CN CONSOLIDATION                  CR CORROSION                  AL ATTERBERG LIMITS                  CO COLLAPSE/SWELL                  RV R-VALUE</p>
---	---	--

# Geotechnical Boring Log LGC-BA-4

Date : 12/12/2018	Page 3 of 3	Drilling Company : Al Roy Drilling
Project Name : John S Gibson Blvd		Type of Rig : Earthdrill
Project Number : 12091-01		Drop : 12"      Hole Diameter : 26"
Elevation of Top of Hole : ~ 70 ' MSL		Drive Weight : #2400, 0' to 23'; #1550, 24' to 43'; #850, 43' to 62'
Hole Location : See Geotechnical Map		

Elevation (ft)	Depth (ft)	Graphic Log	Attitudes	Sample Number	Blow Count	Dry Density(pcf)	Moisture (%)	USCS Symbol	DESCRIPTION	Type of Test
	60	█		R-6	50/9"	98.6	8.0	SP-SM	@ 60' SANDSTONE with some Silt: light yellowish brown, moist, very dense	
5	65								<b>Total Depth = 61.5'</b> <b>No Ground Water Encountered</b> <b>Backfilled with Cuttings on 12/12/2018</b>	
0	70									
-5	75									
-10	80									
-15	85									



THIS SUMMARY APPLIES ONLY AT THE LOCATION OF THIS BORING AND AT THE TIME OF DRILLING. SUBSURFACE CONDITIONS MAY DIFFER AT OTHER LOCATIONS AND MAY CHANGE AT THIS LOCATION WITH THE PASSAGE OF TIME. THE DATA PRESENTED IS A SIMPLIFICATION OF THE ACTUAL CONDITIONS ENCOUNTERED.

**SAMPLE TYPES:**  
 B BULK SAMPLE  
 R RING SAMPLE  
 G GRAB SAMPLE

**TEST TYPES:**  
 DS DIRECT SHEAR  
 MD MAXIMUM DENSITY  
 SA SIEVE ANALYSIS  
 S&H SIEVE AND HYDROMETER  
 EI EXPANSION INDEX  
 CN CONSOLIDATION  
 CR CORROSION  
 AL ATTERBERG LIMITS  
 CO COLLAPSE/SWELL  
 RV R-VALUE

# Geotechnical Boring Log LGC-BA-5

Date : 12/13/2018	Page 1 of 1	Drilling Company : Al Roy Drilling
Project Name : John S Gibson Blvd	Type of Rig : Earthdrill	
Project Number : 12091-01	Drop : 12"	Hole Diameter : 26"
Elevation of Top of Hole : ~ 60' MSL	Drive Weight : #2400, 0' to 23'; #1550, 24' to 43'; #850, 43' to 62'	
Hole Location : See Geotechnical Map		

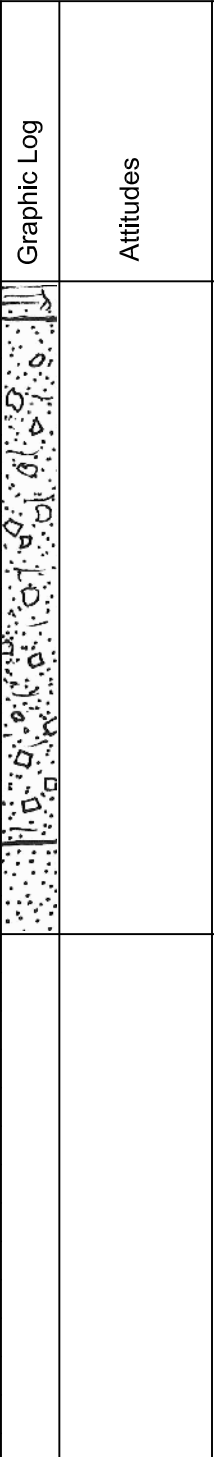
Elevation (ft)	Depth (ft)	Graphic Log	Attitudes	Sample Number	Blow Count	Dry Density(pcf)	Moisture (%)	USCS Symbol	DESCRIPTION	Type of Test
	0								<p style="text-align: center;">Logged by KTM Sampled by KTM</p> <p><b>@ 0' to 14.5' Undocumented Artificial Fill (afu)</b>                      @ 0' Clayey SILT and SAND: dark brown, very moist                      @ 1' SAND: black, moist; oil; strong petroliferous odor; slag pieces up to 6" in diameter</p> <p><b>@ 5' SAND with some Silt:</b> light to dark gray, moist, slightly dense; scattered bricks; decrease moisture; decrease oil staining</p> <p><b>@ 14.5' Quaternary Old Marine Deposits (Qom)</b>                      @ 14.5' Silty fine SAND: light moderate brown, moist, medium dense; slightly odoriferous; lacks visible staining                      @ 16' Bulk sample, small bag</p>	
	55								<p><b>Total Depth = 17'</b>  <b>No Ground Water Encountered</b>  <b>Backfilled with Cuttings on 12/13/2018</b></p>	
	50									
	45									
	40									
	35									



THIS SUMMARY APPLIES ONLY AT THE LOCATION OF THIS BORING AND AT THE TIME OF DRILLING. SUBSURFACE CONDITIONS MAY DIFFER AT OTHER LOCATIONS AND MAY CHANGE AT THIS LOCATION WITH THE PASSAGE OF TIME. THE DATA PRESENTED IS A SIMPLIFICATION OF THE ACTUAL CONDITIONS ENCOUNTERED.

**SAMPLE TYPES:**  
 B BULK SAMPLE  
 R RING SAMPLE  
 G GRAB SAMPLE

**TEST TYPES:**  
 DS DIRECT SHEAR  
 MD MAXIMUM DENSITY  
 SA SIEVE ANALYSIS  
 S&H SIEVE AND HYDROMETER  
 EI EXPANSION INDEX  
 CN CONSOLIDATION  
 CR CORROSION  
 AL ATTERBERG LIMITS  
 CO COLLAPSE/SWELL  
 RV R-VALUE



# Geotechnical Boring Log LGC-BA-6

Date : 12/13/2018	Page 1 of 3	Drilling Company : Al Roy Drilling
Project Name : John S Gibson Blvd	Type of Rig : Earthdrill	
Project Number : 12091-01	Drop : 12"	Hole Diameter : 26"
Elevation of Top of Hole : ~ 67' MSL	Drive Weight : #2400, 0' to 23'; #1550, 24' to 43'; #850, 43' to 62'	
Hole Location : See Geotechnical Map		

Logged by KTM  
Sampled by KTM

Elevation (ft)	Depth (ft)	Graphic Log	Attitudes	Sample Number	Blow Count	Dry Density(pcf)	Moisture (%)	USCS Symbol	DESCRIPTION	Type of Test
65	0			B-1					<p><b>@ 0' Quaternary Old Marine Deposits (Qom)</b>                      @0' to 1.5' Layer of artificial fill consisting of SAND moist, loose; asphalt pieces. Dark petroliferous layer, 1.5" thick. Below is SANDSTONE with some Clay: reddish brown, moist, medium dense; abundant shells</p> <p>@ 3' Coquina bed. Sand matrix; friable; rootlets; minor belling of borehole to depth of 8'</p>	
60	5		J/B: N85W, 17N	R-1	8	5.7		SP-SM	<p>@ 8' SANDSTONE with Silt: light yellow brown, slightly moist, very weakly cemented. Joint/bedding attitude</p> <p>@ 10' SANDSTONE with trace Silt: light reddish brown to light yellowish brown, slightly moist, medium dense; highly friable</p>	
55	10		B:N52W,7N	R-2	15	104.7	3.1	SP-SM	<p>@ 14' Bedding attitude on very thin silt lens in sandstone; iron oxide laminations; trace fossils; few white mineral stringers up to 1/4" thick</p> <p>@ 18' Subvertical, non-planar silty clasts; soft sediment offsets</p> <p>@ 20' Very fine SANDSTONE with some Silt: light yellowish brown, slightly moist, dense; very weakly cemented</p> <p>@ 21' SANDSTONE: light yellow brown, slightly moist, medium dense; very friable; faintly laminated; intermittent belling of borehole to 32'</p>	
50	15									
45	20									
40	25									



THIS SUMMARY APPLIES ONLY AT THE LOCATION OF THIS BORING AND AT THE TIME OF DRILLING. SUBSURFACE CONDITIONS MAY DIFFER AT OTHER LOCATIONS AND MAY CHANGE AT THIS LOCATION WITH THE PASSAGE OF TIME. THE DATA PRESENTED IS A SIMPLIFICATION OF THE ACTUAL CONDITIONS ENCOUNTERED.

<p><b>SAMPLE TYPES:</b>                  B BULK SAMPLE                  R RING SAMPLE                  G GRAB SAMPLE</p>	<p><b>TEST TYPES:</b>                  DS DIRECT SHEAR                  MD MAXIMUM DENSITY                  SA SIEVE ANALYSIS                  S&amp;H SIEVE AND HYDROMETER                  EI EXPANSION INDEX                  CN CONSOLIDATION                  CR CORROSION                  AL ATTERBERG LIMITS                  CO COLLAPSE/SWELL                  RV R-VALUE</p>
--	---

Last Edited: 12/21/2018



# Geotechnical Boring Log LGC-BA-6

Date : 12/13/2018	Page 2 of 3	Drilling Company : Al Roy Drilling
Project Name : John S Gibson Blvd	Type of Rig : Earthdrill	
Project Number : 12091-01	Drop : 12"	Hole Diameter : 26"
Elevation of Top of Hole : ~ 67' MSL	Drive Weight : #2400, 0' to 23'; #1550, 24' to 43'; #850, 43' to 62'	
Hole Location : See Geotechnical Map		

Logged by KTM  
Sampled by KTM

Elevation (ft)	Depth (ft)	Graphic Log	Attitudes	Sample Number	Blow Count	Dry Density(pcf)	Moisture (%)	USCS Symbol	DESCRIPTION	Type of Test
30			B: N19W, 4E	R-3	24	111.7	3.4	SP-SM	<p>@ 30' Fine SANDSTONE with trace Silt: light yellowish brown, slightly moist, dense</p> <p>@ 32' Coquina - Silty SAND: light yellowish brown, moist, dense; abundant shells up to 50%</p> <p>@ 36' SILTSTONE with Clay: light brownish gray, very moist, very stiff</p> <p>@ 38' Bedding attitude on sand with laminations lens, 4" thick</p> <p>@ 40' SANDSTONE with trace Silt: orangish brown, slightly moist, dense to very dense</p> <p>@ 45' Bedding attitude on thin silt lenses.</p> <p>@ 49' Subhorizontal contact with Clayey SILTSTONE: up to 1/2" thick; interbedded</p> <p>@ 50' Clayey SILTSTONE: light greenish brown, very moist, very stiff to slightly hard; iron oxide lined rootcasts. Thinly interbedded SANDSTONE and SILTSTONE below.</p> <p>@ 56' Bedding attitude. Generally grades to unoxidized below.</p>	
35										
35										
30										
40						R-4	30/10"	107.8		5.8
25										
45			B: N50W, 8N							
20										
50				R-5	50/9"	95.3	29.0	ML/CL		
15										
55										
10			B: N72W, 6N							



THIS SUMMARY APPLIES ONLY AT THE LOCATION OF THIS BORING AND AT THE TIME OF DRILLING. SUBSURFACE CONDITIONS MAY DIFFER AT OTHER LOCATIONS AND MAY CHANGE AT THIS LOCATION WITH THE PASSAGE OF TIME. THE DATA PRESENTED IS A SIMPLIFICATION OF THE ACTUAL CONDITIONS ENCOUNTERED.

**SAMPLE TYPES:**  
 B BULK SAMPLE  
 R RING SAMPLE  
 G GRAB SAMPLE

**TEST TYPES:**  
 DS DIRECT SHEAR  
 MD MAXIMUM DENSITY  
 SA SIEVE ANALYSIS  
 S&H SIEVE AND HYDROMETER  
 EI EXPANSION INDEX  
 CN CONSOLIDATION  
 CR CORROSION  
 AL ATTERBERG LIMITS  
 CO COLLAPSE/SWELL  
 RV R-VALUE

# Geotechnical Boring Log LGC-BA-6

Date : 12/13/2018	Page 3 of 3	Drilling Company : Al Roy Drilling
Project Name : John S Gibson Blvd	Type of Rig : Earthdrill	
Project Number : 12091-01	Drop : 12"	Hole Diameter : 26"
Elevation of Top of Hole : ~ 67' MSL	Drive Weight : #2400, 0' to 23'; #1550, 24' to 43'; #850, 43' to 62'	
Hole Location : See Geotechnical Map		

Elevation (ft)	Depth (ft)	Graphic Log	Attitudes	Sample Number	Blow Count	Dry Density(pcf)	Moisture (%)	USCS Symbol	DESCRIPTION	Type of Test
	60	█		R-6	35	92.7	30.4	CL	Logged by KTM Sampled by KTM  @ 60' CLAYSTONE: dark gray, very moist, very stiff; unoxidized. End visual log.	
	5								Total Depth = 61' No Ground Water Encountered Backfilled with Cuttings on 12/13/2018	
	65									
	0									
	70									
	-5									
	75									
	-10									
	80									
	-15									
	85									
	-20									



THIS SUMMARY APPLIES ONLY AT THE LOCATION OF THIS BORING AND AT THE TIME OF DRILLING. SUBSURFACE CONDITIONS MAY DIFFER AT OTHER LOCATIONS AND MAY CHANGE AT THIS LOCATION WITH THE PASSAGE OF TIME. THE DATA PRESENTED IS A SIMPLIFICATION OF THE ACTUAL CONDITIONS ENCOUNTERED.

**SAMPLE TYPES:**  
 B BULK SAMPLE  
 R RING SAMPLE  
 G GRAB SAMPLE

**TEST TYPES:**  
 DS DIRECT SHEAR  
 MD MAXIMUM DENSITY  
 SA SIEVE ANALYSIS  
 S&H SIEVE AND HYDROMETER  
 EI EXPANSION INDEX  
 CN CONSOLIDATION  
 CR CORROSION  
 AL ATTERBERG LIMITS  
 CO COLLAPSE/SWELL  
 RV R-VALUE

*From Lawson, 2005*

# Geotechnical Boring Log LGC-1

Date: 09/23/04	Page: 1 of 2	Drilling Company: Alroy Drilling
Project Name: San Pedro Self-Storage	Type of Rig: E100 BUCKET AUGER	
Project Number: 041104-01	Drop: 12"	Hole Diameter: 24"
Elevation of Top of Hole: 74 ft	Drive Weight: 2400lbs.@0-22',	
Hole Location: See Geotechnical Map	1550lbs.@22'-42', 850lbs.@ 42'-65'	

Elevation (ft)	Depth (ft)	Graphic Log	Attitudes	Sample Number	Blow Count	Dry Density (pcf)	Moisture (%)	USCS Symbol	DESCRIPTION	Type of Test
74	0							SM	<p><b>Quaternary Terrace Deposits - Non-Marine</b>                      Partially to fully lithified terrace deposits                      @ 0' Fine Sandstone: mottled orange-brown and light brown, dry, loose to medium dense; weakly cemented                      @ 1.5' Silty fine Sandstone: light yellow, slightly brown to gray, dry to damp, medium dense                      @ 4' Scattered Clayey Silt Clasts with iron oxide up to 2" diameter                      @ 5' Silty fine Sandstone: light yellowish brown to gray, dry to damp, medium dense                      @ 6.5' Undulatory change to orange color, increase in scattered clasts</p>	
69	5		R-1	12	100.1	5.7			@ 8' Increase in moisture to very damp, increasing silt	MD
			B-1							
64	10		R-2	12	102.6	8.4			@ 10' Silty fine Sandstone: orangish brown mottled with gray inclusions, moist, dense; weakly cemented, few siltstone clasts, iron oxide staining, trace micas, well sorted fine sand	DS
59	15								@ 15' Base of inclusion zone, massive below, decrease Silt content	
54	20		R-3	12	99.6	7.2			@ 20' Fine Sandstone with silt: light to dark mottled orange-brown, moist, dense; few quartz grains, zones intensely mottled with iron oxide, trace fossils, oval white sand from burrows, colors vary faintly	SA/AL
									@ 23' Subhorizontal oxidation band	
49	25								@ 24' Siltstone Clasts to 3" diameter, varies with depth	
								@ 27' Silty Fine Sandstone with intense oxidation mottling, moisture consistent		
								@ 28-29' Intense Oxidation stain, lower west side		
								@ 29' Sandstone: yellowish light gray, becomes iron oxide stained with depth		
44	30							@ 30' Becomes Sandstone with Silt: light yellow gray brown; more homogenous then above		

<p><b>LAWSON AND ASSOCIATES</b>  <b>GEOTECHNICAL CONSULTING, INC.</b></p> <div style="text-align: center; font-size: 2em; font-weight: bold; background-color: black; color: white; padding: 5px;">LGC</div>	<p><b>SAMPLE TYPES:</b>                  B BULK SAMPLE                  R RING SAMPLE                  G GRAB SAMPLE                  SPT STANDARD PENETRATION TEST SAMPLE</p>	<p><b>TEST TYPES:</b>                  DS DIRECT SHEAR                  MD MAXIMUM DENSITY                  SA SIEVE ANALYSIS                  S&amp;H SIEVE AND HYDROMETER                  EI EXPANSION INDEX                  CN CONSOLIDATION                  CR CORROSION                  AL ATTERBERG LIMITS                  CO COLLAPSE/SWELL                  RV R-VALUE</p>
--	--	---

# Geotechnical Boring Log LGC-1

Date: 09/23/04	Page: 2 of 2	Drilling Company: Alroy Drilling
Project Name: San Pedro Self-Storage	Type of Rig: E100 BUCKET AUGER	
Project Number: 041104-01	Drop: 12"	Hole Diameter: 24"
Elevation of Top of Hole: 74 ft	Drive Weight: 2400lbs.@0-22',	
Hole Location: See Geotechnical Map	1550lbs.@22'-42', 850lbs.@ 42'-65'	

Elevation (ft)	Depth (ft)	Graphic Log	Attitudes	Sample Number	Blow Count	Dry Density (pcf)	Moisture (%)	USCS Symbol	Logged By: KTM Sampled By: KTM  DESCRIPTION	Type of Test
44	30								<b>Quaternary Terrace Deposits - Non-Marine (Continued)</b>  @ 33' Decrease oxidation staining, Sandstone is gray  @ 35' Iron oxide staining, forms halos around siltstone inclusions  @ 39.5' Thin zone of Manganese oxide staining subhorizontal @ 40' Silty fine Sandstone to fine Sandy Siltstone: mottled orange, brown, and minor light gray, very moist, dense; variable color and material, iron oxide staining follows material type edges, weakly cemented, Clasts of silt, increased silt content to 47'  @ 47' Silty Fine Sandstone: gray brown, moist, dense; lacks clasts, micaceous, faint oxidation staining  @ 55' Scattered clasts of siltstone, increase in moisture with depth  @ 60' As above @ 40' except color darker, very moist to wet  LOGGED TO 68' NO GROUNDWATER ENCOUNTERED TD = 61' BACKFILLED AND TAMPED 9/23/04	
39	35									
34	40		R-4	18	108.7	13.7				
29	45									
24	50									
19	55									
14	60			R-5	50	106.9	19.5			

**LAWSON AND ASSOCIATES  
GEOTECHNICAL CONSULTING, INC.**

LGC

**SAMPLE TYPES:**  
 B BULK SAMPLE  
 R RING SAMPLE  
 G GRAB SAMPLE  
 SPT STANDARD PENETRATION TEST SAMPLE

**TEST TYPES:**  
 DS DIRECT SHEAR  
 MD MAXIMUM DENSITY  
 SA SIEVE ANALYSIS  
 S&H SIEVE AND HYDROMETER  
 EI EXPANSION INDEX  
 CN CONSOLIDATION  
 CR CORROSION  
 AL ATTERBERG LIMITS  
 CO COLLAPSE/SWELL  
 RV R-VALUE

# Geotechnical Boring Log LGC-2

Date: 09/23/04	Page: 1 of 2	Drilling Company: Alroy Drilling
Project Name: San Pedro Self-Storage	Type of Rig: E100 BUCKET AUGER	
Project Number: 041104-01	Drop: 12"	Hole Diameter: 24"
Elevation of Top of Hole: 67 ft	Drive Weight: 2400lbs.@0-22',	
Hole Location: See Geotechnical Map	1550lbs.@22'-42', 850lbs.@ 42'-65'	

Elevation (ft)	Depth (ft)	Graphic Log	Attitudes	Sample Number	Blow Count	Dry Density (pcf)	Moisture (%)	USCS Symbol	DESCRIPTION	Type of Test
67	0							SM	<b>Quaternary Terrace Deposits - Non-Marine</b> @ 0-1.5' Silty Fine Sand: light yellow, dry, loose to slightly dense; scattered pebbles and roots @ 1.5' Dense, slightly damp, roots along joint @ 3' Zone of joints, poorly defined, scattered, gray mottled with iron oxide @ 5' Silty fine Sandstone: light orange brown, dry to slightly damp, dense; micaceous @ 5-6' Generalized Bedding, 1 foot layer of sand, faint crossbeds @ 6' Base of multiple joints, lined with a white crystalline material 1/8" thick  @ 8' Fine Sand: gray brown, Silty Laminations: Bedding Attitude on base of bed @ 9' Roots and bedding along Joint @ 10' Fine Sandy Siltstone to Silty Sandstone: orangish brown mottled lightly, slightly moist, dense; slightly micaceous, inclusions of fine Sandy Silt @ 11' - 13' Bag Sample, as above  @ 15' Bedding on Sand with laminations offset along joint approximately 2 inches, below is moist, iron oxide, scattered trace fossils  @ 20' Fine Sandy Siltstone to Silty Sandstone: orangish brown mottled lightly, slightly moist, dense; slightly micaceous  @ 24' Lens of Sand, 1 inch thick @ 25' Bedding 6 inch Sand Bed. Shear, 2 inch offset down and west  @ 27' Sand Bed, 12 inch thick with laminations parallel to above  @ 29' Gray colored zone, 6 inch thick	
62	5		@ 3' J: N5E,71E @ 5' GB: N5E,11E @ 6' J: N2W,82E	R-1	13	110.2	4.4			
57	10		@ 9' J: N5E,74W & B: N21E,16E	R-2 B-1	9	108.7	8.9			CR EI/CR
52	15		@ 15' B: N25E,9E							
47	20			R-3	11	96.5	8.4			
42	25		@ 25' B: N42E,9E & SH: N40W,51W							
37	30									

<p><b>LAWSON AND ASSOCIATES</b>  <b>GEOTECHNICAL CONSULTING, INC.</b></p> <div style="text-align: center; font-size: 2em; font-weight: bold; background-color: black; color: white; padding: 5px;">LGC</div>	<p><b>SAMPLE TYPES:</b>                  B BULK SAMPLE                  R RING SAMPLE                  G GRAB SAMPLE                  SPT STANDARD PENETRATION TEST SAMPLE</p>	<p><b>TEST TYPES:</b>                  DS DIRECT SHEAR                  MD MAXIMUM DENSITY                  SA SIEVE ANALYSIS                  S&amp;H SIEVE AND HYDROMETER                  EI EXPANSION INDEX                  CN CONSOLIDATION                  CR CORROSION                  AL ATTERBERG LIMITS                  CO COLLAPSE/SWELL                  RV R-VALUE</p>
--	--	---

# Geotechnical Boring Log LGC-2

Date: 09/23/04	Page: 2 of 2	Drilling Company: Alroy Drilling
Project Name: San Pedro Self-Storage	Type of Rig: E100 BUCKET AUGER	
Project Number: 041104-01	Drop: 12"	Hole Diameter: 24"
Elevation of Top of Hole: 67 ft	Drive Weight: 2400lbs.@0-22', 1550lbs.@22'-42', 850lbs.@ 42'-65'	
Hole Location: See Geotechnical Map		

Elevation (ft)	Depth (ft)	Graphic Log	Attitudes	Sample Number	Blow Count	Dry Density (pcf)	Moisture (%)	USCS Symbol	DESCRIPTION	Type of Test	
37	30								Logged By: KTM Sampled By: KTM		
32	35								<b>Quaternary Terrace Deposits - Non-Marine (Continued)</b>		
27	40			@ 42' J: N40E,47N	R-4	18	109.8	14.6		@37' Transitions to fine Sandy Siltstone: variable sand content, iron oxide, scattered trace fossils (oval-shaped, sand filled burrows)  @40' Fine Sandy Siltstone: brown, moist, medium dense/stiff; variable sand content, variable oxidation  @ 42' Joint	
22	45									@ 49' Silty Sandstone: brown, very moist, dense: micaceous	
17	50			@ 51' B: N48W,10N						@ 51' Bedding, laminated, colorful Sand bed, 6 inch thick, continuous  Downhole logged to 51'	
12	55									@ 55' Top of caved zone, groundwater  @57' Standing Water at base of caved/belled zone @60' Silty fine Sandstone, dark orange and brown mottled, wet, dense; caved material	
7	60				R-5	50	108.0	20.9		GROUNDWATER @ 55' TD = 61' BACKFILLED AND TAMPED 9/23/04	DS

<p style="text-align: center;"><b>LAWSON AND ASSOCIATES GEOTECHNICAL CONSULTING, INC.</b></p> <div style="text-align: center; font-size: 2em; font-weight: bold; background-color: black; color: white; padding: 10px; margin: 10px auto; width: 80%;">LGC</div>	<p><b>SAMPLE TYPES:</b></p> <p>B BULK SAMPLE              R RING SAMPLE              G GRAB SAMPLE              SPT STANDARD PENETRATION TEST SAMPLE</p>	<p><b>TEST TYPES:</b></p> <table style="width: 100%; border: none;"> <tr> <td style="width: 33%;">DS DIRECT SHEAR</td> <td style="width: 33%;">CN CONSOLIDATION</td> </tr> <tr> <td>MD MAXIMUM DENSITY</td> <td>CR CORROSION</td> </tr> <tr> <td>SA SIEVE ANALYSIS</td> <td>AL ATTERBERG LIMITS</td> </tr> <tr> <td>S&amp;H SIEVE AND HYDROMETER</td> <td>CO COLLAPSE/SWELL</td> </tr> <tr> <td>EI EXPANSION INDEX</td> <td>RV R-VALUE</td> </tr> </table>	DS DIRECT SHEAR	CN CONSOLIDATION	MD MAXIMUM DENSITY	CR CORROSION	SA SIEVE ANALYSIS	AL ATTERBERG LIMITS	S&H SIEVE AND HYDROMETER	CO COLLAPSE/SWELL	EI EXPANSION INDEX	RV R-VALUE
DS DIRECT SHEAR	CN CONSOLIDATION											
MD MAXIMUM DENSITY	CR CORROSION											
SA SIEVE ANALYSIS	AL ATTERBERG LIMITS											
S&H SIEVE AND HYDROMETER	CO COLLAPSE/SWELL											
EI EXPANSION INDEX	RV R-VALUE											

# Geotechnical Boring Log LGC-3

Date: 09/23/04	Page: 1 of 2	Drilling Company: Alroy Drilling
Project Name: San Pedro Self-Storage	Type of Rig: E100 BUCKET AUGER	
Project Number: 041104-01	Drop: 12"	Hole Diameter: 24"
Elevation of Top of Hole: 57 ft	Drive Weight: 2400lbs.@0-22',	
Hole Location: See Geotechnical Map	1550lbs.@22'-42', 850lbs.@ 42'-65'	

Elevation (ft)	Depth (ft)	Graphic Log	Attitudes	Sample Number	Blow Count	Dry Density (pcf)	Moisture (%)	USCS Symbol	DESCRIPTION	Type of Test
57	0							SM	<p><u>Quaternary Terrace Deposits - Non-Marine</u></p> <p>@ 0' Silty Fine Sandstone: light orange brown and light gray mottled, dry, slightly dense</p> <p>@ 2' Damp, dense, roots</p> <p>@ 4' Joints: Silt lined, scattered Silty Clasts, weakly cemented, few scattered zones of moderately cemented, irregularly shaped</p> <p>@ 5' Silty fine Sandstone: light grayish brown, dry, dense; weakly cemented, few clasts of Siltstone</p> <p>@ 8 to 10' Bag Sample as below @ 10'</p> <p>@ 10' Silty fine Sandstone: dark orange brown and gray mottled, moist, dense; Silty clasts / inclusions, iron oxide staining</p> <p>@ 19' Joint, some Sand infill</p> <p>@ 20' Silty fine Sandstone: gray and light orange-brown mottled, moist, dense</p> <p>@ 21' Shear, Silt and Clay lined, 1/2 inch thick, likely small offset; Inclusions of light gray Silt, scattered light gray trace fossils</p> <p>@ 25' Inclusions are brown and Clayey</p> <p>@ 27' Well cemented pods; irregular shapes, 4" diameter typical, calcite cement</p> <p>@ 28' Lens of well cemented Sandstone, 2 inch thick</p>	
52	5		@ 4' J: N58W,56S	R-1	13	99.7	4.8			CN
47	10			B-1						
				R-2	11 for 9"	102.4	7.6			SAVAL
42	15									
37	20		@ 19' J: N48W, VERT							
			@ 21' SH: N65W,55N	R-3	13	96.8	6.5			
32	25									
27	30									

**LAWSON AND ASSOCIATES  
GEOTECHNICAL CONSULTING, INC.**

**SAMPLE TYPES:**  
 B BULK SAMPLE  
 R RING SAMPLE  
 G GRAB SAMPLE  
 SPT STANDARD PENETRATION TEST SAMPLE

**TEST TYPES:**  
 DS DIRECT SHEAR  
 MD MAXIMUM DENSITY  
 SA SIEVE ANALYSIS  
 S&H SIEVE AND HYDROMETER  
 EI EXPANSION INDEX  
 CN CONSOLIDATION  
 CR CORROSION  
 AL ATTERBERG LIMITS  
 CO COLLAPSE/SWELL  
 RV R-VALUE



# Geotechnical Boring Log LGC-3

Date: 09/23/04	Page: 2 of 2	Drilling Company: Alroy Drilling
Project Name: San Pedro Self-Storage	Type of Rig: E100 BUCKET AUGER	
Project Number: 041104-01	Drop: 12"	Hole Diameter: 24"
Elevation of Top of Hole: 57 ft	Drive Weight: 2400lbs.@0-22',	
Hole Location: See Geotechnical Map	1550lbs.@22'-42', 850lbs.@ 42'-65'	

Elevation (ft)	Depth (ft)	Graphic Log	Attitudes	Sample Number	Blow Count	Dry Density (pcf)	Moisture (%)	USCS Symbol	DESCRIPTION	Type of Test
27	30		@ 42' J:N60W,51N						Logged By: KTM Sampled By: KTM	
22	35			R-4	30 for 7"	103.9	10.1		<u>Quaternary Terrace Deposits - Non-Marine (Continued)</u>  @ 35' Silty fine Sandstone to Fine Sandy Siltstone: dark orange and brown mottled, moist, dense; micaceous @ 36' Scattered trace fossils, iron oxide, gradual increase in moisture	DS
17	40									@ 42' Shear, Silt lined shear, tight, increase in moisture below to very moist to wet
12	45								Downhole logged to 48'	
7	50			R-5	50 for 7"	106.5	21.0		@ 50' as above @ 35' except wet	
2	55								LOGGED TO 48' GROUNDWATER @ 50' TD = 51' BACKFILLED AND TAMPED 9/23/04	
-3	60									

<p><b>LAWSON AND ASSOCIATES</b>  <b>GEOTECHNICAL CONSULTING, INC.</b></p> <div style="text-align: center; font-size: 2em; font-weight: bold; background-color: black; color: white; padding: 5px;">LGC</div>	<p><b>SAMPLE TYPES:</b></p> <p>B BULK SAMPLE              R RING SAMPLE              G GRAB SAMPLE              SPT STANDARD PENETRATION TEST SAMPLE</p>	<p><b>TEST TYPES:</b></p> <p>DS DIRECT SHEAR              MD MAXIMUM DENSITY              SA SIEVE ANALYSIS              S&amp;H SIEVE AND HYDROMETER              EI EXPANSION INDEX</p> <p>CN CONSOLIDATION              CR CORROSION              AL ATTERBERG LIMITS              CO COLLAPSE/SWELL              RV R-VALUE</p>
--	--	---

# Lawson & Associates

Operator: ML-DH  
 Sounding: CPT-01  
 Cone Used: DSA0408

CPT Date/Time: 11/5/2004 3:50:26 PM  
 Location: San Pedro Self Storage  
 Job Number: 041104

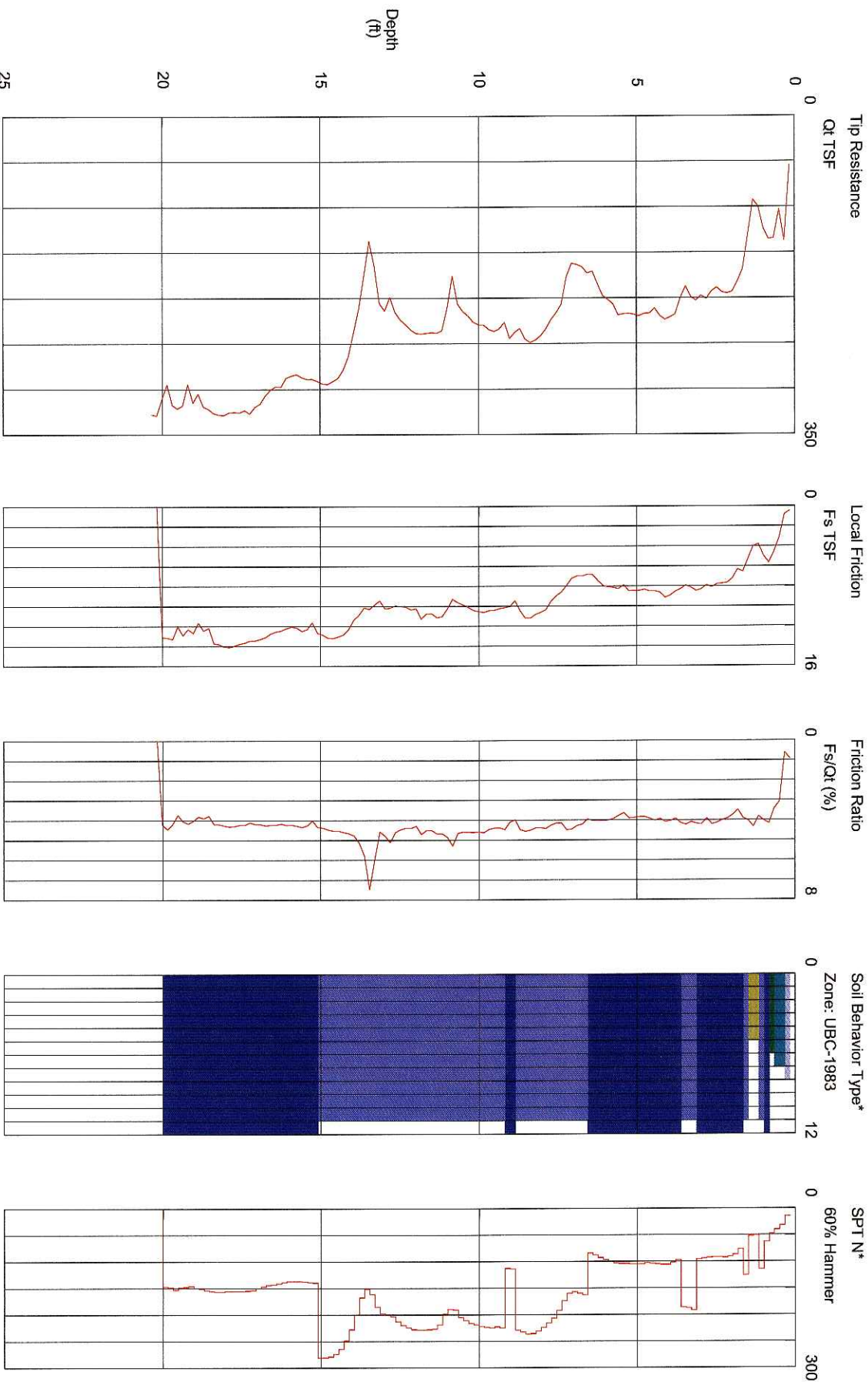

Maximum Depth = 20.34 feet

Depth Increment = 0.164 feet

- 1 sensitive fine grained
- 2 organic material
- 3 clay

- 4 silty clay to clay
- 5 clayey silt to silty clay
- 6 sandy silt to clayey silt

- 7 silty sand to sandy silt
- 8 sand to silty sand
- 9 sand

- 10 gravelly sand to sand
- 11 very stiff fine grained (\*)
- 12 sand to clayey sand (\*)

\*Soil behavior type and SPT based on data from UBC-1983

*From Lawson, 2007a*

# Geotechnical Boring Log LGC-4

Date : 7/11/2007	Page 1 of 2	Drilling Company : ALROY
Project Name : SELF STORAGE SAN PEDRO	Type of Rig : E100 BA	
Project Number : 041104-01	Drop : 12"	Hole Diameter : 24"
Elevation of Top of Hole : ~ 71' MSL	Drive Weight : 2400lbs @0-22'; 1550lbs @22'-42'; 850lbs @42'-65'	
Hole Location : See Geotechnical Map		

Elevation (ft)	Depth (ft)	Graphic Log	Attitudes	Sample Number	Blow Count	Dry Density (pcf)	Moisture (%)	USCS Symbol	DESCRIPTION	Type of Test
70	0			B1				SM/SP	<p><b>Quaternary Terrace Deposits - Non Marine (Qt)</b></p> <p>0-3' Fine grained SANDSTONE: mottled light to orange brown, dry, loose to moderately dense; moderately indurated; micaceous; common roots and rootlets; moderately weathered</p> <p>3' Fine grained Silty SANDSTONE: mottled light olive gray brown, slightly moist, medium dense; moderately to well indurated; faint orange oxidation spotting and banding along cross bedding</p> <p>4.5' General cross-bedding</p> <p>6-7' Common manganese-oxide spotting, black 1/8" diameter</p> <p>7' Fine grained Silty SANDSTONE: mottled light gray brown orange, slightly moist, medium dense; moderately indurated; common orange iron oxidation, spotting and irregular staining; common Clayey SILT clasts (rip-up) to 2' diameter ringed by heavy oxidation</p> <p>11' Fine grained Silty SANDSTONE: light olive gray with orange mottling, slightly moist, medium dense; moderately to well indurated; massive</p> <p>14' Grades into Sandy SILTSTONE/Silty SANDSTONE: mottled olive light orange brown; very micaceous; common random Silty CLAY clasts (rip-up) to 2" in length; massive</p> <p>19' One-inch diameter root; few 1" diameter circular calcium carbonate spotting</p> <p>20.5' Fine grained SANDSTONE: mottled olive brown to light orange brown, moist, moderately dense; well indurated; well defined cross-bedding marked by jarosite(yellow) and iron(orange) oxidation banding</p> <p>21.5' Cross-bedding</p> <p>22.5' Six-inch diameter cobble</p> <p>24' Fine grained Silty SANDSTONE: light olive gray brown, moist, moderately dense; well indurated; micaceous; downward fining</p> <p>29'-36' Common irregular iron oxidation spotting and lineations; few olive gray Clayey SILT clasts(rip-up)</p>	
65	5		B:N20E,7N	R-1	10	93.7	8.5			
60	10									
55	15			R-2	10	102.5	11.1			
50	20		B: EW, 10S							
45	25			R-3	23	99.5	12.8			

Last Edited: 7/19/2007

**LAWSON AND ASSOCIATES  
GEOTECHNICAL CONSULTING, INC.**



THIS SUMMARY APPLIES ONLY AT THE LOCATION OF THIS BORING AND AT THE TIME OF DRILLING. SUBSURFACE CONDITIONS MAY DIFFER AT OTHER LOCATIONS AND MAY CHANGE AT THIS LOCATION WITH THE PASSAGE OF TIME. THE DATA PRESENTED IS A SIMPLIFICATION OF THE ACTUAL CONDITIONS ENCOUNTERED.

**SAMPLE TYPES:**  
 B BULK SAMPLE  
 R RING SAMPLE  
 G GRAB SAMPLE

**TEST TYPES:**  
 OS DIRECT SHEAR  
 MD MAXIMUM DENSITY  
 SA SIEVE ANALYSIS  
 S&H SIEVE AND HYDROMETER  
 EI EXPANSION INDEX  
 CN CONSOLIDATION  
 CR CORROSION  
 AL ATTERBERG LIMITS  
 CO COLLAPSE/SWELL  
 RV R-VALUE

# Geotechnical Boring Log LGC-4

Date : 7/11/2007	Page 2 of 2	Drilling Company : ALROY
Project Name : SELF STORAGE SAN PEDRO	Type of Rig : E100 BA	
Project Number : 041104-01	Drop : 12"	Hole Diameter : 24"
Elevation of Top of Hole : ~ 71' MSL	Drive Weight : 2400lbs @0-22'; 1550lbs @22'-42'; 850lbs @42'-65'	
Hole Location : See Geotechnical Map		

Elevation (ft)	Depth (ft)	Graphic Log	Attitudes	Sample Number	Blow Count	Dry Density (pcf)	Moisture (%)	USCS Symbol	DESCRIPTION	Type of Test	
40	30							SM/SP	Continue Quaternary Terrace Deposits - Non Marine (Qt)		
35	35		R-4	20	102.4	8.7			36' Fine grained Silty SANDSTONE: mottled light olive gray to brown orange, moist, moderately dense; well indurated; common random oxidation; slightly cemented	DS	
30	40								41' Fine grained Silty SANDSTONE: mottled light olive gray, slightly moist, moderately dense; very well indurated; massive 45' Fine grained SANDSTONE: white with black mica flakes, moist, moderately dense; micaceous; 1" thick		
25	45		B: N15E, 6N	R-5	50/10'	102.5	13.2				
20	50									50' Sandy SILTSTONE/Silty SANDSTONE: mottled olive gray orange; well indurated; massive; slight downward coarsening; micaceous; few calcium carbonate concretions to 1" diameter	
15	55				R-6	40	103.1	23.0			
Total Depth = 60' No Ground Water Encountered Backfilled with Cuttings on 7/11/2007											

<b>LAWSON AND ASSOCIATES</b> <b>GEOTECHNICAL CONSULTING, INC.</b> 	THIS SUMMARY APPLIES ONLY AT THE LOCATION OF THIS BORING AND AT THE TIME OF DRILLING. SUBSURFACE CONDITIONS MAY DIFFER AT OTHER LOCATIONS AND MAY CHANGE AT THIS LOCATION WITH THE PASSAGE OF TIME. THE DATA PRESENTED IS A SIMPLIFICATION OF THE ACTUAL CONDITIONS ENCOUNTERED.	<table border="0"> <tr> <td style="vertical-align: top;"> <b>SAMPLE TYPES:</b>                      B BULK SAMPLE                      R RING SAMPLE                      G GRAB SAMPLE                 </td> <td style="vertical-align: top;"> <b>TEST TYPES:</b>                      DS DIRECT SHEAR                      MD MAXIMUM DENSITY                      SA SIEVE ANALYSIS                      S&amp;H SIEVE AND HYDROMETER                      EI EXPANSION INDEX                      CN CONSOLIDATION                      CR CORROSION                      AL ATTERBERG LIMITS                      CO COLLAPSE/SWELL                      RV R-VALUE                 </td> </tr> </table>	<b>SAMPLE TYPES:</b> B BULK SAMPLE R RING SAMPLE G GRAB SAMPLE	<b>TEST TYPES:</b> DS DIRECT SHEAR MD MAXIMUM DENSITY SA SIEVE ANALYSIS S&H SIEVE AND HYDROMETER EI EXPANSION INDEX CN CONSOLIDATION CR CORROSION AL ATTERBERG LIMITS CO COLLAPSE/SWELL RV R-VALUE
<b>SAMPLE TYPES:</b> B BULK SAMPLE R RING SAMPLE G GRAB SAMPLE	<b>TEST TYPES:</b> DS DIRECT SHEAR MD MAXIMUM DENSITY SA SIEVE ANALYSIS S&H SIEVE AND HYDROMETER EI EXPANSION INDEX CN CONSOLIDATION CR CORROSION AL ATTERBERG LIMITS CO COLLAPSE/SWELL RV R-VALUE			

# Geotechnical Boring Log LGC-5

Date : 7/11/2007	Page 1 of 2	Drilling Company : ALROY
Project Name : SELF STORAGE SAN PEDRO	Type of Rig : E100 BA	
Project Number : 041104-01	Drop : 12"	Hole Diameter : 24"
Elevation of Top of Hole : ~ 45' MSL	Drive Weight : 2400lbs @0-22'; 1550lbs @22'-42'; 850lbs @42'-65'	
Hole Location : See Geotechnical Map		

Elevation (ft)	Depth (ft)	Graphic Log	Attitudes	Sample Number	Blow Count	Dry Density (pcf)	Moisture (%)	USCS Symbol	DESCRIPTION	Type of Test
45	0							SM/SP	Logged by SDH Sampled by SDH  Artificial Fill - Undocumented (afu) 0-2" Asphalt pavement (AC) 2"-1.5' Silty SAND and 3/4 Rock: brown, dry, loose; common AC clasts 1.5'-3' Silty SAND; light brown, dry to slightly moist, medium dense; AC pavement clasts and roots throughout Quaternary Terrace Deposits - Non Marine (Qt) 3.5' Fine grained Silty SAND; light gray white, slightly moist, medium dense; very micaceous; massive; few rootlets 6' Sandy SILTSTONE/Silty SANDSTONE: mottled olivegray to orange brown, slightly moist, medium dense; moderately indurated; few olive gray Silty CLAY clasts (rip-up) 2"-4" long/diameter 8' Grades into fine grained SANDSTONE: yellow orange, slightly moist, medium dense; moderately indurated; few iron oxidation spots and halos  13' One-inch diameter root 14' Fine grained Silty SANDSTONE: light brown orange, slightly moist, medium dense; moderately to well indurated; micaceous; faint cross-bedding	
40	5			B1 R-1	6	94.0	3.4			
30	15			R-2	15	95.1	5.7		20' Concretion 6" diameter 20.5' Fine grained SANDSTONE: white to light gray, moist, medium dense; moderately to well indurated; faint cross-bedding; micaceous; few random Clayey SILT filled joints, 1/16" wide with orange iron oxidation halos 23.5' Fine grained Sandy SILTSTONE: mottled olive orange brown, moist, medium dense; massive; very micaceous; moderately weathered and friable 24.5' Becomes very well indurated	DS
20	25			R-3	16	103.1	20.7		26' Common calcium carbonate spotting; common discontinuous 1"-2" thick lenses of white fine Sand with black mica flakes	

**LAWSON AND ASSOCIATES  
GEOTECHNICAL CONSULTING, INC.**



THIS SUMMARY APPLIES ONLY AT THE LOCATION OF THIS BORING AND AT THE TIME OF DRILLING. SUBSURFACE CONDITIONS MAY DIFFER AT OTHER LOCATIONS AND MAY CHANGE AT THIS LOCATION WITH THE PASSAGE OF TIME. THE DATA PRESENTED IS A SIMPLIFICATION OF THE ACTUAL CONDITIONS ENCOUNTERED.

**SAMPLE TYPES:**  
 B BULK SAMPLE  
 R RING SAMPLE  
 G GRAB SAMPLE

**TEST TYPES:**  
 DS DIRECT SHEAR  
 MD MAXIMUM DENSITY  
 SA SIEVE ANALYSIS  
 S&H SIEVE AND HYDROMETER  
 EI EXPANSION INDEX  
 CN CONSOLIDATION  
 CR CORROSION  
 AL ATTERBERG LIMITS  
 CO COLLAPSE/SWELL  
 RV R-VALUE

# Geotechnical Boring Log LGC-5

Date : 7/11/2007	Page 2 of 2	Drilling Company : ALROY
Project Name : SELF STORAGE SAN PEDRO	Type of Rig : E100 BA	
Project Number : 041104-01	Drop : 12"	Hole Diameter : 24"
Elevation of Top of Hole : ~ 45' MSL	Drive Weight : 2400lbs @0-22'; 1550lbs @22'-42'; 850lbs @42'-65'	
Hole Location : See Geotechnical Map		

Elevation (ft)	Depth (ft)	Graphic Log	Attitudes	Sample Number	Blow Count	Dry Density (pcf)	Moisture (%)	USCS Symbol	DESCRIPTION	Type of Test
15	30							SM/SP	Logged by SDH Sampled by SDH  Continue Quaternary Terrace Deposits - Non Marine (Qt)	
10	35		R-4	35	103.1	21.5			32.5' Fine grained SANDSTONE: white, moist, medium dense; very well indurated; micaceous; very faint cross-bedding 33.5' Fine grained Sandy SILTSTONE: mottled olive orange, very moist, medium dense; massive; common orange oxidation spotting	
5	40									38' Concretionary zone with seeping water 39'-40' Standing water
0	45								Total Depth = 40' Ground Water Encountered @ 38' Backfilled with Cuttings on 7/11/2007	
-5	50									
-10	55									

**LAWSON AND ASSOCIATES  
GEOTECHNICAL CONSULTING, INC.**



THIS SUMMARY APPLIES ONLY AT THE LOCATION OF THIS BORING AND AT THE TIME OF DRILLING. SUBSURFACE CONDITIONS MAY DIFFER AT OTHER LOCATIONS AND MAY CHANGE AT THIS LOCATION WITH THE PASSAGE OF TIME. THE DATA PRESENTED IS A SIMPLIFICATION OF THE ACTUAL CONDITIONS ENCOUNTERED.

**SAMPLE TYPES:**  
 B BULK SAMPLE  
 R RING SAMPLE  
 G GRAB SAMPLE

**TEST TYPES:**  
 DS DIRECT SHEAR  
 MD MAXIMUM DENSITY  
 SA SIEVE ANALYSIS  
 S&H SIEVE AND HYDROMETER  
 EI EXPANSION INDEX  
 CN CONSOLIDATION  
 CR CORROSION  
 AL ATTERBERG LIMITS  
 CO COLLAPSE/SWELL  
 RV R-VALUE

*Appendix C*  
*Laboratory Test Results*



## *APPENDIX C*

### *Laboratory Test Results*

The laboratory testing program was directed towards providing quantitative data relating to the relevant engineering properties of the soils. Samples considered representative of site conditions were tested in general accordance with American Society for Testing and Materials (ASTM) procedure and/or California Test Methods (CTM), where applicable. The following summary is a brief outline of the test type and a table summarizing the test results.

Moisture and Density Determination Tests: Moisture content (ASTM D2216) and dry density determinations (ASTM D2937) were performed on driven samples obtained from the test borings. The results of these tests are presented in the boring logs. Where applicable, only moisture content was determined from undisturbed or disturbed samples.

Grain Size Distribution/Fines Content: Representative samples were dried, weighed, and soaked in water until individual soil particles were separated (per ASTM D421) and then washed on a No. 200 sieve (ASTM D1140). Where applicable, the portion retained on the No. 200 sieve was dried and then sieved on a U.S. Standard brass sieve set in accordance with ASTM D6913 (sieve) or ASTM D422 (sieve and hydrometer).

<b>Sample Location</b>	<b>Description</b>	<b>% Passing # 200 Sieve</b>
LGC-BA-1 @ 5-9 ft	Silty Sand	33
LGC-BA-1 @ 10 ft	Silty Sand	13
LGC-BA-2 @ 10 ft	Silty Sand	49
LGC-BA-3 @ 2-5 ft	Silty Sand	32
LGC-BA-3 @ 10 ft	Silty Sand	32
LGC-BA-3 @ 40 ft	Silty Clay with Sand	77
LGC-BA-4 @ 3-5 ft	Silty Sand	44
LGC-BA-4 @ 10 ft	Silty Sand	26

**APPENDIX C (Cont'd)**

**Laboratory Test Results**

**Atterberg Limits:** The liquid and plastic limits (“Atterberg Limits”) were determined per ASTM D4318 for engineering classification of fine-grained material and presented in the table below. The USCS soil classification indicated in the table below is based on the portion of sample passing the No. 40 sieve and may not necessarily be representative of the entire sample. The plots are provided in this Appendix.

<b>Sample Location</b>	<b>Liquid Limit (%)</b>	<b>Plastic Limit (%)</b>	<b>Plasticity Index (%)</b>	<b>USCS Soil Classification</b>
LGC-BA-1 @ 5-9 ft	NP	NP	NP	-
LGC-BA-1 @ 30 ft	39	27	12	ML
LGC-BA-2 @ 14 ft	46	29	17	ML
LGC-BA-3 @ 10 ft	NP	NP	NP	-
LGC-BA-4 @ 3-5 ft	NP	NP	NP	-

**Laboratory Compaction:** The maximum dry density and optimum moisture content of typical materials were determined in accordance with ASTM D1557. The results are presented in the table below.

<b>Sample Location</b>	<b>Sample Description</b>	<b>Maximum Dry Density (pcf)</b>	<b>Optimum Moisture Content (%)</b>
LGC-BA-1 @ 5-9 ft	Yellowish Brown Silty Sand	113.5	13.5
LGC-BA-3 @ 2-5 ft	Yellowish Brown Silty Sand	128.0	9.5
LGC-BA-4 @ 3-5 ft	Dark Yellowish Brown Silty Sand	129.0	8.0

**Direct Shear:** Direct shear tests were performed on selected driven samples, which were soaked for a minimum of 24 hours prior to testing. The samples were tested under various normal loads using a motor-driven, strain-controlled, direct-shear testing apparatus (ASTM D3080). The plots are provided in this Appendix.

**Soluble Sulfates:** The soluble sulfate contents of selected samples were determined by standard geochemical methods (CTM 417). The test results are presented in the table below.

<b>Sample Location</b>	<b>Sulfate Content (ppm)</b>	<b>Sulfate Content (%)</b>
LGC-BA-1 @ 5-9 ft	78	< 0.01
LGC-BA-3 @ 2-5 ft	365	< 0.04
LGC-BA-4 @ 3-5 ft	179	< 0.02

*APPENDIX C (Cont'd)*

**Laboratory Test Results**

Chloride Content: Chloride content was tested per CTM 422. The results are presented below.

<b>Sample Location</b>	<b>Chloride Content (ppm)</b>
LGC-BA-1 @ 5-9 ft	70
LGC-BA-3 @ 2-5 ft	81
LGC-BA-4 @ 3-5 ft	84

Minimum Resistivity and pH Tests: Minimum resistivity and pH tests were performed in general accordance with CTM 643 and standard geochemical methods. The results are presented in the table below.

<b>Sample Location</b>	<b>pH</b>	<b>Minimum Resistivity (ohms-cm)</b>
LGC-BA-1 @ 5-9 ft	7.4	1,560
LGC-BA-3 @ 2-5 ft	8.3	1,685
LGC-BA-4 @ 3-5 ft	7.1	1,098



# PARTICLE-SIZE ANALYSIS OF SOILS

ASTM D 422

Project Name: San Pedro/John S. Gibson Blvd.      Tested By: G. Berdy      Date: 02/08/19  
 Project No.: 12091-01      Data Input By: J. Ward      Date: 02/15/19  
 Boring No.: BA-1  
 Sample No.: B-1      Depth (feet): 5-9  
 Soil Identification: Yellowish brown silty sand (SM), shells noted

<b>% Gravel</b>	<b>2</b>	<b>Soil Type</b>  <b>SM</b>	Moisture Content of Total Air-Dry Soil	Moisture Content of Air-Dry Soil Passing #10	After Hydrometer & Wet Sieve ret. in #200 Sieve
<b>% Sand</b>	<b>65</b>				
<b>% Fines</b>	<b>33</b>				

Specific Gravity (Assumed)	2.70	Wt. of Air-Dry Soil + Cont. (g)	0.00	81.68	
Correction for Specific Gravity	0.99	Dry Wt. of Soil + Cont. (g)	0.00	81.67	144.86
Wt. of Air-Dry Soil + Cont. (g)	1382.81	Wt. of Container No. ____ (g)	1.00	68.18	77.44
Wt. of Container	223.61	Moisture Content (%)	0.00	0.07	
Dry Wt. of Soil (g)	1159.20	Wt. of Dry Soil (g)			67.42

Coarse Sieve		
U.S. Sieve	Cumulative Wt. Of Dry Soil Retained (g)	% Passing
3"	0.00	100.0
1½"	0.00	100.0
¾"	14.24	98.8
⅜"	16.58	98.6
No. 4	26.36	97.7
No. 10	37.32	96.8
Pan		

Sieve after Hydrometer & Wet Sieve			
U.S. Sieve Size	Cumulative Wt. Of Dry Soil Retained (g)	% Passing	% Total Sample
No. 10	0.00	100.0	96.8
No. 16	1.01	99.0	95.8
No. 30	5.77	94.2	91.2
No. 50	19.63	80.3	77.7
No. 100	39.24	60.5	58.6
No. 200	65.91	33.7	32.6
Pan			

**Hydrometer**

Wt. of Air-Dry Soil (g) 99.50
Wt. of Dry Soil (g) 99.43

Deflocculant 125 cc of 4% Solution

Date	Time	Elapsed Time (min)	Water Temperature (°C)	Composite Correction 152H	Actual Hydrometer Readings	% Total Sample (%)	Soil Particle Diameter (mm)
11-Feb-19	7:18	0		8.0			
	7:20	2	22.7	8.0	33.0	24.1	0.0306
	7:23	5	22.7	8.0	29.0	20.3	0.0199
	7:33	15	22.5	8.0	26.0	17.4	0.0117
	7:48	30	22.3	8.0	24.0	15.4	0.0084
	8:18	60	21.9	8.0	22.0	13.5	0.0061
	9:18	120	21.3	8.0	21.0	12.6	0.0044
	11:28	250	21.0	8.0	19.0	10.6	0.0031
12-Feb-19	7:18	1440	22.3	8.0	15.5	7.2	0.0013

GRAVEL				SAND				FINES			
COARSE		FINE		CRSE	MEDIUM		FINE	SILT		CLAY	

U.S. STANDARD SIEVE OPENING

3.0" 1 1/2" 3/4" 3/8" #4

U.S. STANDARD SIEVE NUMBER

#8 #16 #30 #50 #100 #200

HYDROMETER

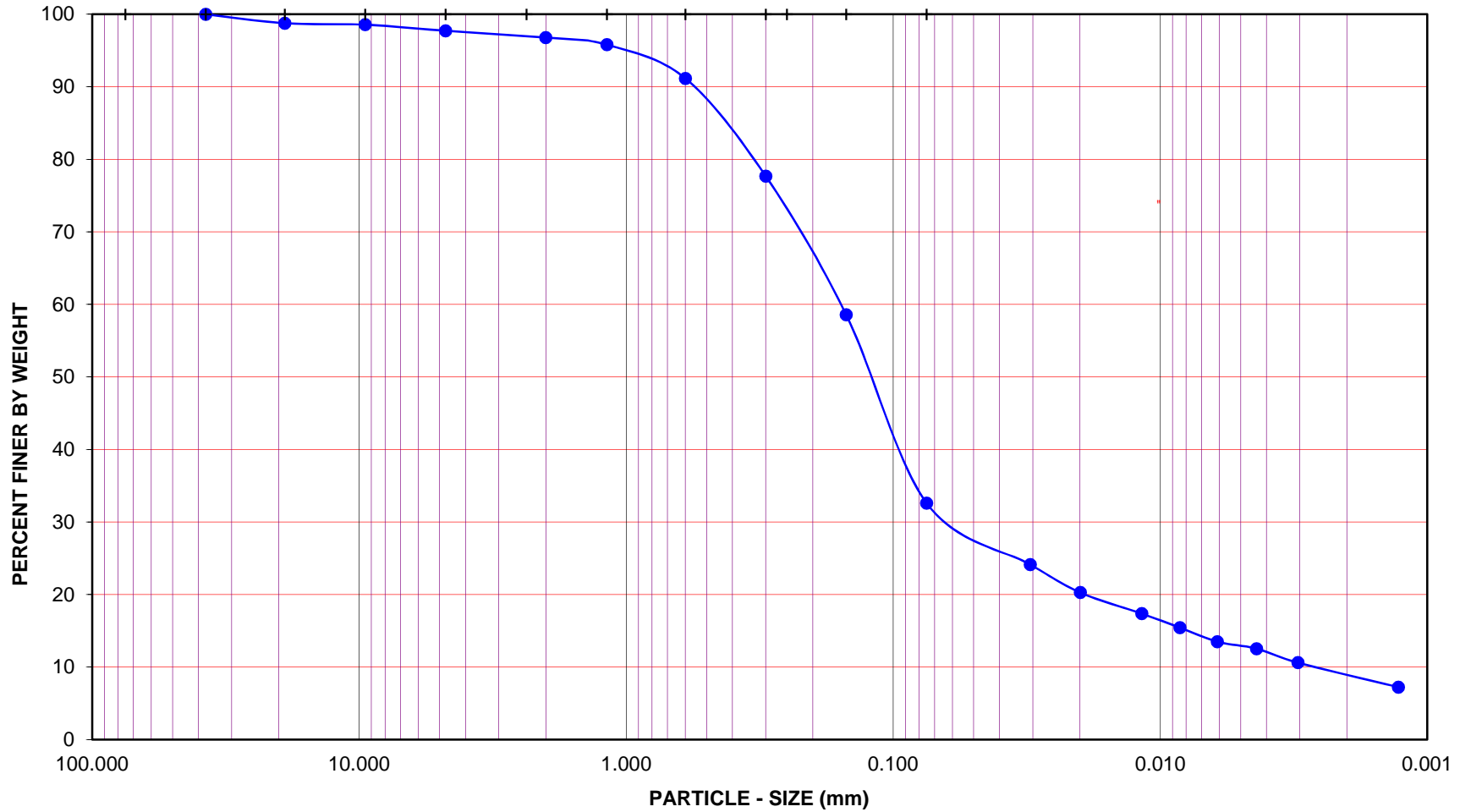

Project Name: San Pedro/John S. Gibson Blvd.

Project No.: 12091-01

Boring No.: BA-1

Sample No.: B-1

Depth (feet): 5-9

Soil Type : SM

Soil Identification: Yellowish brown silty sand (SM), shells noted

GR:SA:FI : (%)      **2 : 65 : 33**



**PARTICLE - SIZE  
DISTRIBUTION  
ASTM D 422**

Feb-19

Boring No.	BA-1	BA-2						
Sample No.	R-1	R-1						
Depth (ft.)	10.0	10.0						
Sample Type	Ring	Ring						
Soil Identification	Light olive brown silty sand (SM)	Light olive brown silty sand (SM)						
<b>Moisture Correction</b>								
Wet Weight of Soil + Container (g)	0.00	0.00						
Dry Weight of Soil + Container (g)	0.00	0.00						
Weight of Container (g)	1.00	1.00						
Moisture Content (%)	0.00	0.00						
<b>Sample Dry Weight Determination</b>								
Weight of Sample + Container (g)	583.87	569.49						
Weight of Container (g)	237.12	219.59						
Weight of Dry Sample (g)	346.75	349.90						
Container No.:								
<b>After Wash</b>								
Method (A or B)	B	B						
Dry Weight of Sample + Cont. (g)	540.69	397.21						
Weight of Container (g)	237.12	219.59						
Dry Weight of Sample (g)	303.57	177.62						
<b>% Passing No. 200 Sieve</b>	<b>12.5</b>	<b>49.2</b>						
<b>% Retained No. 200 Sieve</b>	87.5	50.8						
 <b>Leighton</b>	<b>PERCENT PASSING No. 200 SIEVE ASTM D 1140</b>				Project Name: <u>San Pedro/John S. Gibson Blvd.</u>			
					Project No.: <u>12091-01</u>			
					Tested By: <u>G. Bathala</u>		Date: <u>02/11/19</u>	



# PARTICLE-SIZE ANALYSIS OF SOILS

ASTM D 422

Project Name: San Pedro/John S. Gibson Blvd.      Tested By: G. Berdy      Date: 02/08/19  
 Project No.: 12091-01      Data Input By: J. Ward      Date: 02/15/19  
 Boring No.: BA-3  
 Sample No.: B-1      Depth (feet): 2-5  
 Soil Identification: Yellowish brown silty sand (SM), shells noted

<b>% Gravel</b>	<b>2</b>	<b>Soil Type</b>  <b>SM</b>	Moisture Content of Total Air-Dry Soil	Moisture Content of Air-Dry Soil Passing #10	After Hydrometer & Wet Sieve ret. in #200 Sieve
<b>% Sand</b>	<b>66</b>				
<b>% Fines</b>	<b>32</b>				

Specific Gravity (Assumed)	2.70	Wt. of Air-Dry Soil + Cont. (g)	0.00	66.41	
Correction for Specific Gravity	0.99	Dry Wt. of Soil + Cont. (g)	0.00	66.40	145.59
Wt. of Air-Dry Soil + Cont. (g)	1490.30	Wt. of Container No. ____ (g)	1.00	51.40	77.13
Wt. of Container	241.77	Moisture Content (%)	0.00	0.07	
Dry Wt. of Soil (g)	1248.53	Wt. of Dry Soil (g)			68.46

Coarse Sieve		
U.S. Sieve	Cumulative Wt. Of Dry Soil Retained (g)	% Passing
3"	0.00	100.0
1½"	0.00	100.0
¾"	0.00	100.0
⅜"	17.10	98.6
No. 4	21.67	98.3
No. 10	43.63	96.5
Pan		

Sieve after Hydrometer & Wet Sieve			
U.S. Sieve Size	Cumulative Wt. Of Dry Soil Retained (g)	% Passing	% Total Sample
No. 10	0.00	100.0	96.5
No. 16	1.14	98.9	95.4
No. 30	6.16	93.8	90.6
No. 50	21.03	79.0	76.2
No. 100	41.09	58.9	56.9
No. 200	67.33	32.7	31.6
Pan			

**Hydrometer**

Wt. of Air-Dry Soil (g) 100.16
Wt. of Dry Soil (g) 100.09

Deflocculant 125 cc of 4% Solution

Date	Time	Elapsed Time (min)	Water Temperature (°C)	Composite Correction 152H	Actual Hydrometer Readings	% Total Sample (%)	Soil Particle Diameter (mm)
11-Feb-19	7:14	0		8.0			
	7:16	2	22.7	8.0	33.0	23.9	0.0306
	7:19	5	22.7	8.0	29.0	20.1	0.0199
	7:29	15	22.5	8.0	26.0	17.2	0.0117
	7:44	30	22.3	8.0	24.0	15.3	0.0084
	8:14	60	21.9	8.0	22.0	13.4	0.0061
	9:14	120	21.2	8.0	21.0	12.4	0.0044
	11:24	250	20.9	8.0	20.0	11.5	0.0031
12-Feb-19	7:14	1440	22.2	8.0	16.0	7.7	0.0013

GRAVEL				SAND				FINES			
COARSE		FINE		CRSE	MEDIUM		FINE	SILT		CLAY	

U.S. STANDARD SIEVE OPENING

3.0" 1 1/2" 3/4" 3/8" #4

U.S. STANDARD SIEVE NUMBER

#8 #16 #30 #50 #100 #200

HYDROMETER

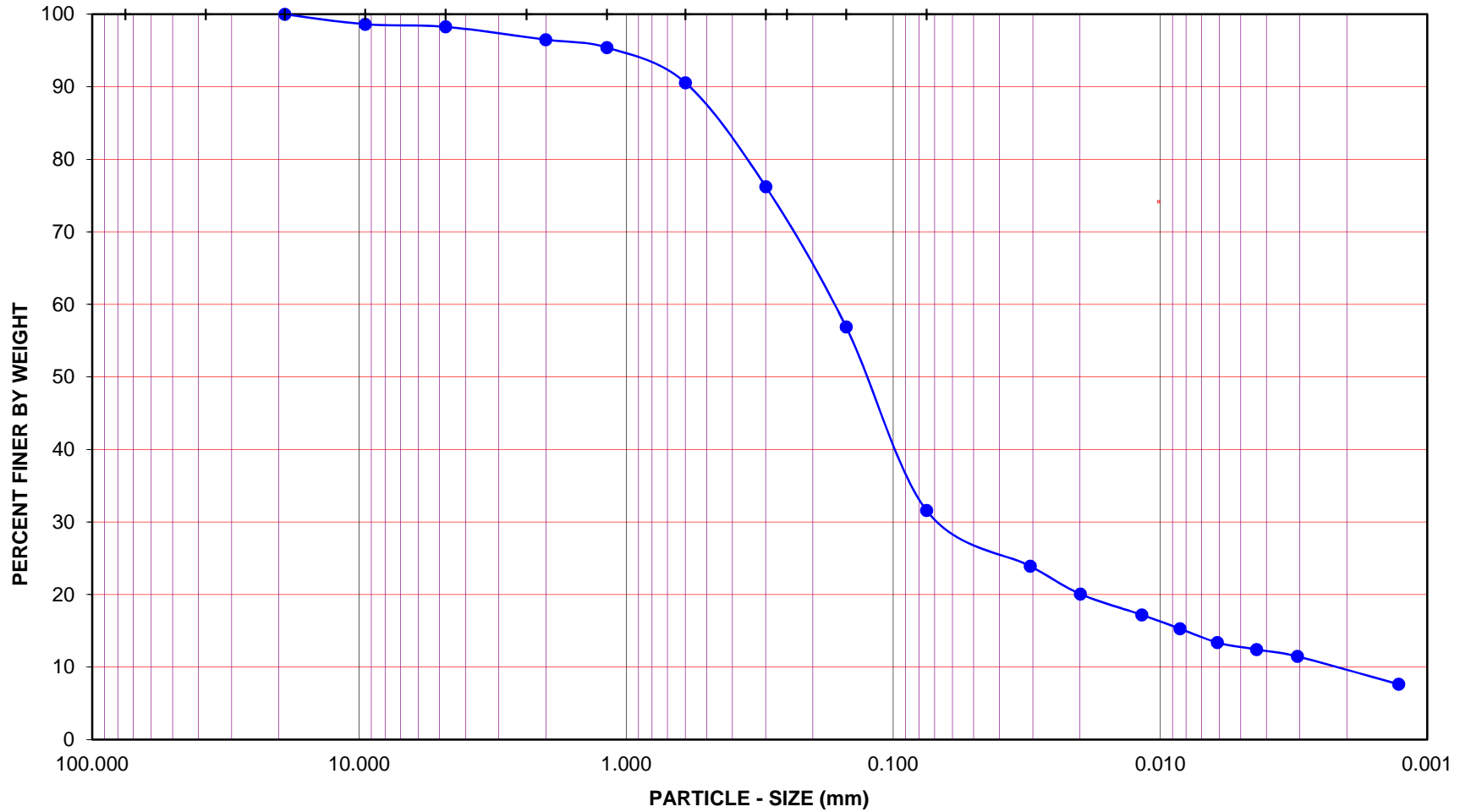

Project Name: San Pedro/John S. Gibson Blvd.

Project No.: 12091-01

Boring No.: BA-3

Sample No.: B-1

Depth (feet): 2-5

Soil Type : SM

Soil Identification: Yellowish brown silty sand (SM), shells noted

GR:SA:FI : (%)      **2 : 66 : 32**



**PARTICLE - SIZE DISTRIBUTION**  
ASTM D 422

Feb-19

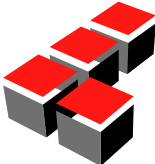

Boring No.	BA-3							
Sample No.	R-1							
Depth (ft.)	10.0							
Sample Type	Ring							
Soil Identification	Yellowish brown silty sand (SM)							
<b>Moisture Correction</b>								
Wet Weight of Soil + Container (g)	0.00							
Dry Weight of Soil + Container (g)	0.00							
Weight of Container (g)	1.00							
Moisture Content (%)	0.00							
<b>Sample Dry Weight Determination</b>								
Weight of Sample + Container (g)	527.75							
Weight of Container (g)	137.70							
Weight of Dry Sample (g)	390.05							
Container No.:								
<b>After Wash</b>								
Method (A or B)	B							
Dry Weight of Sample + Cont. (g)	404.57							
Weight of Container (g)	137.70							
Dry Weight of Sample (g)	266.87							
<b>% Passing No. 200 Sieve</b>	<b>31.6</b>							
<b>% Retained No. 200 Sieve</b>	<b>68.4</b>							
 <b>Leighton</b>	<b>PERCENT PASSING No. 200 SIEVE ASTM D 1140</b>				Project Name: <u>San Pedro/John S. Gibson Blvd.</u>			
					Project No.: <u>12091-01</u>			
					Tested By: <u>R. Manning</u>		Date: <u>02/07/19</u>	



# PARTICLE-SIZE ANALYSIS OF SOILS

ASTM D 422

Project Name: San Pedro/John S. Gibson Blvd.      Tested By: G. Berdy      Date: 12/20/18  
 Project No.: 12091-01      Data Input By: J. Ward      Date: 01/19/19  
 Boring No.: BA-4  
 Sample No.: B-1      Depth (feet): 3-5  
 Soil Identification: Dark yellowish brown silty sand (SM)

<b>% Gravel</b>	<b>3</b>	<b>Soil Type</b>  <b>SM</b>	Moisture Content of Total Air-Dry Soil	Moisture Content of Air-Dry Soil Passing #10	After Hydrometer & Wet Sieve ret. in #200 Sieve
<b>% Sand</b>	<b>53</b>				
<b>% Fines</b>	<b>44</b>				

Specific Gravity (Assumed)	2.70	Wt. of Air-Dry Soil + Cont.(g)	0.00	82.71	
Correction for Specific Gravity	0.99	Dry Wt. of Soil + Cont. (g)	0.00	82.70	122.74
Wt. of Air-Dry Soil + Cont. (g)	494.85	Wt. of Container No. ____ (g)	1.00	69.57	82.68
Wt. of Container	75.79	Moisture Content (%)	0.00	0.08	
Dry Wt. of Soil (g)	419.06	Wt. of Dry Soil (g)			40.06

Coarse Sieve		
U.S. Sieve	Cumulative Wt. Of Dry Soil Retained (g)	% Passing
3"	0.00	100.0
1½"	0.00	100.0
¾"	0.00	100.0
⅜"	10.43	97.5
No. 4	12.62	97.0
No. 10	13.85	96.7
Pan		

Sieve after Hydrometer & Wet Sieve			
U.S. Sieve Size	Cumulative Wt. Of Dry Soil Retained (g)	% Passing	% Total Sample
No. 10	0.00	100.0	96.7
No. 16	0.40	99.4	96.2
No. 30	1.71	97.6	94.4
No. 50	6.55	91.0	88.0
No. 100	20.56	71.7	69.3
No. 200	39.47	45.7	44.2
Pan			

**Hydrometer**

Wt. of Air-Dry Soil (g) 72.73
Wt. of Dry Soil (g) 72.67

Deflocculant 125 cc of 4% Solution

Date	Time	Elapsed Time (min)	Water Temperature (°C)	Composite Correction 152H	Actual Hydrometer Readings	% Total Sample (%)	Soil Particle Diameter (mm)
21-Dec-18	7:26	0		8.0			
	7:28	2	23.2	8.0	33.0	33.0	0.0303
	7:31	5	23.2	8.0	28.0	26.4	0.0198
	7:41	15	23.2	8.0	24.0	21.1	0.0118
	7:56	30	23.2	8.0	22.0	18.5	0.0084
	8:26	60	23.1	8.0	20.5	16.5	0.0060
	9:26	120	23.3	8.0	19.5	15.2	0.0043
	11:36	250	23.6	8.0	18.0	13.2	0.0030
22-Dec-18	7:26	1440	22.4	8.0	15.5	9.9	0.0013

GRAVEL				SAND				FINES			
COARSE		FINE		CRSE	MEDIUM		FINE	SILT		CLAY	

U.S. STANDARD SIEVE OPENING

U.S. STANDARD SIEVE NUMBER

HYDROMETER

3.0" 1 1/2" 3/4" 3/8" #4 #8 #16 #30 #50 #100 #200

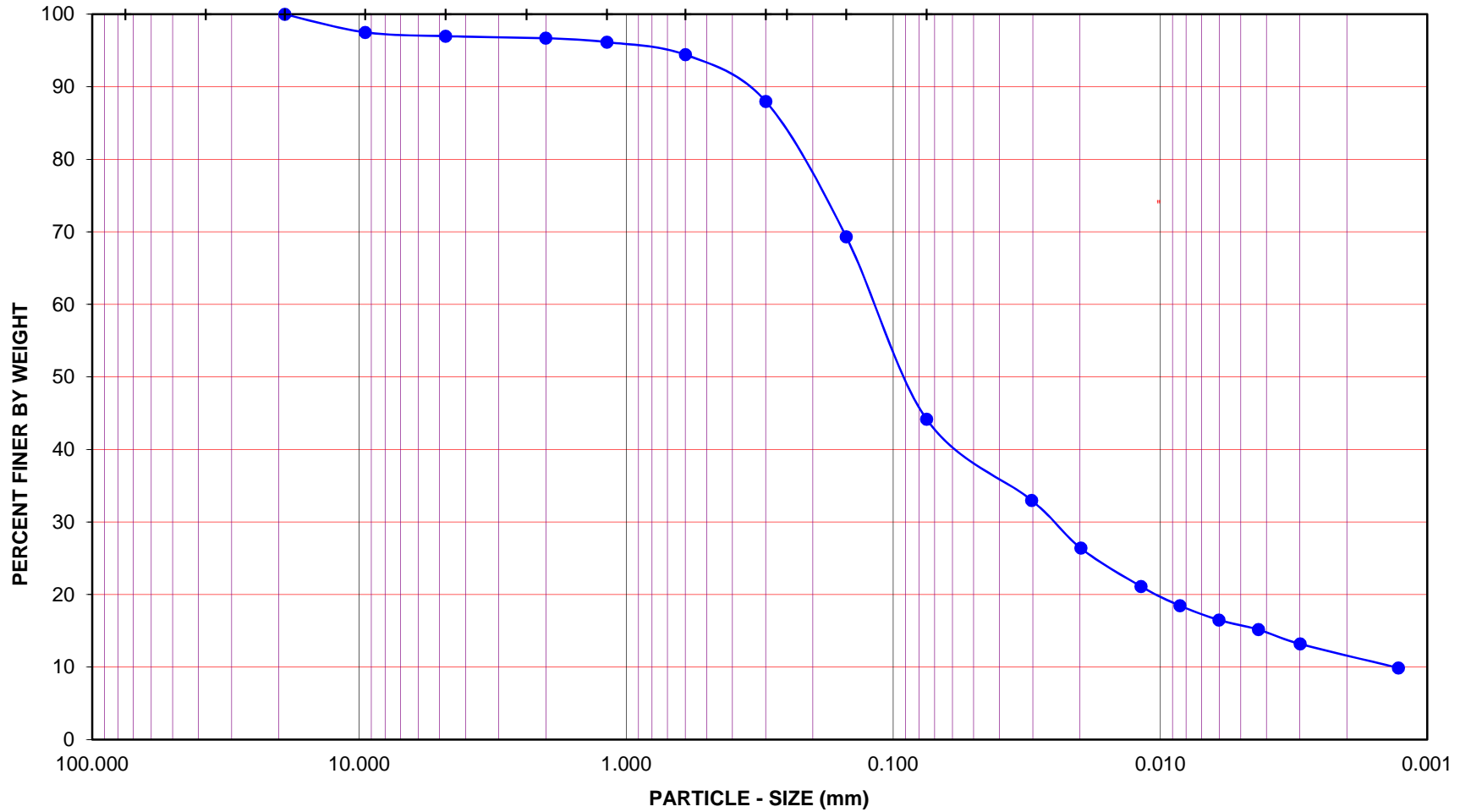

Project Name: San Pedro/John S. Gibson Blvd.

Project No.: 12091-01

Boring No.: BA-4

Sample No.: B-1

Depth (feet): 3-5

Soil Type : SM

Soil Identification: Dark yellowish brown silty sand (SM)

GR:SA:FI : (%) **3 : 53 : 44**



**PARTICLE - SIZE  
DISTRIBUTION  
ASTM D 422**

Jan-19

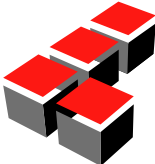
Boring No.	BA-3	BA-4						
Sample No.	R-4	R-1						
Depth (ft.)	40.0	10.0						
Sample Type	Ring	Ring						
Soil Identification	Light olive brown silty clay with sand (CL-ML)s	Yellowish brown silty sandstone (SM), trace clay noted						
<b>Moisture Correction</b>								
Wet Weight of Soil + Container (g)	0.00	0.00						
Dry Weight of Soil + Container (g)	0.00	0.00						
Weight of Container (g)	1.00	1.00						
Moisture Content (%)	0.00	0.00						
<b>Sample Dry Weight Determination</b>								
Weight of Sample + Container (g)	454.27	453.35						
Weight of Container (g)	132.61	95.76						
Weight of Dry Sample (g)	321.66	357.59						
Container No.:								
<b>After Wash</b>								
Method (A or B)	B	B						
Dry Weight of Sample + Cont. (g)	207.54	359.00						
Weight of Container (g)	132.61	95.76						
Dry Weight of Sample (g)	74.93	263.24						
<b>% Passing No. 200 Sieve</b>	<b>76.7</b>	<b>26.4</b>						
<b>% Retained No. 200 Sieve</b>	23.3	73.6						
 <b>Leighton</b>	<b>PERCENT PASSING No. 200 SIEVE ASTM D 1140</b>		Project Name: <u>San Pedro/John S. Gibson Blvd.</u>					
			Project No.: <u>12091-01</u>					
			Tested By: <u>G. Bathala</u>			Date: <u>12/21/18</u>		



# ATTERBERG LIMITS

ASTM D 4318

Project Name: San Pedro/John S. Gibson Blvd. Tested By: R. Manning Date: 02/08/19  
 Project No. : 12091-01 Input By: G. Bathala Date: 02/13/19  
 Boring No.: BA-1 Checked By: J. Ward  
 Sample No.: B-1 Depth (ft.) 5-9  
 Soil Identification: Yellowish brown silty sand (SM), shells noted

TEST NO.	PLASTIC LIMIT		LIQUID LIMIT			
	1	2	1	2	3	4
Number of Blows [N]			7			
Wet Wt. of Soil + Cont. (g)	Cannot be rolled:		25.28 Cannot get more than 7 blows:			
Dry Wt. of Soil + Cont. (g)	NonPlastic		23.22 NonPlastic			
Wt. of Container (g)			13.61			
Moisture Content (%) [Wn]			21.44			

<b>Liquid Limit</b>	<b>NP</b>
<b>Plastic Limit</b>	<b>NP</b>
<b>Plasticity Index</b>	<b>NP</b>
<b>Classification</b>	<b>NP</b>

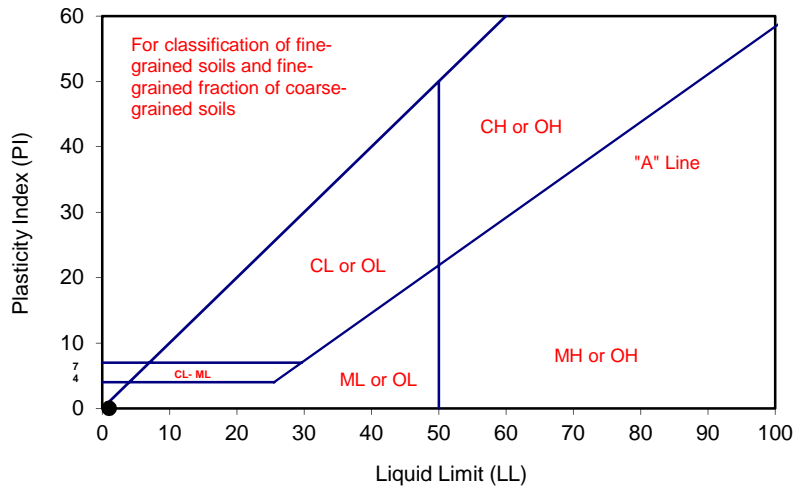

PI at "A" - Line =  $0.73(LL-20)$  =

One - Point Liquid Limit Calculation

$$LL = Wn(N/25)^{0.121}$$

### PROCEDURES USED

- Wet Preparation  
Multipoint - Wet
- Dry Preparation  
Multipoint - Dry
- Procedure A  
Multipoint Test
- Procedure B  
One-point Test

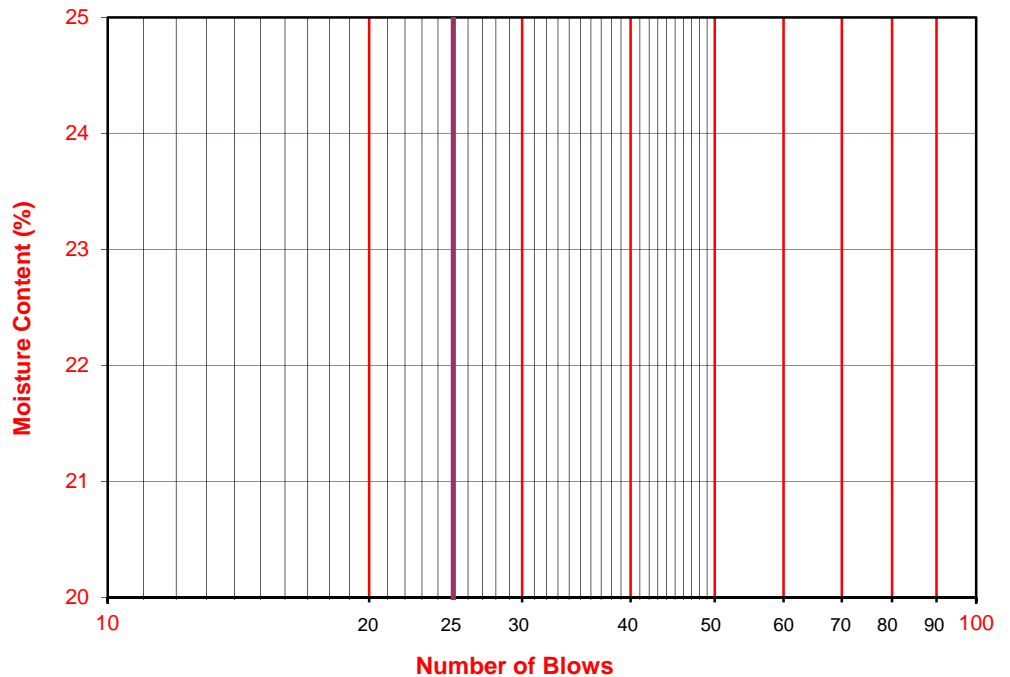



# ATTERBERG LIMITS

ASTM D 4318

Project Name: <u>San Pedro</u>	Tested By: <u>R. Manning</u>	Date: <u>08/22/17</u>
Project No. : <u>12091-01</u>	Input By: <u>G. Bathala</u>	Date: <u>08/23/17</u>
Boring No.: <u>BA-1</u>	Checked By: <u>J. Ward</u>	
Sample No.: <u>R-3</u>	Depth (ft.) <u>30.0</u>	
Soil Identification: <u>Light olive brown silt (ML)</u>		

TEST NO.	PLASTIC LIMIT		LIQUID LIMIT			
	1	2	1	2	3	4
Number of Blows [N]			34	25	16	
Wet Wt. of Soil + Cont. (g)	13.59	13.67	21.27	21.42	22.86	
Dry Wt. of Soil + Cont. (g)	12.22	12.27	19.14	19.19	20.20	
Wt. of Container (g)	7.05	7.05	13.66	13.55	13.57	
Moisture Content (%) [W <sub>n</sub> ]	26.50	26.82	38.87	39.54	40.12	

<b>Liquid Limit</b>	<b>39</b>
<b>Plastic Limit</b>	<b>27</b>
<b>Plasticity Index</b>	<b>12</b>
<b>Classification</b>	<b>ML</b>

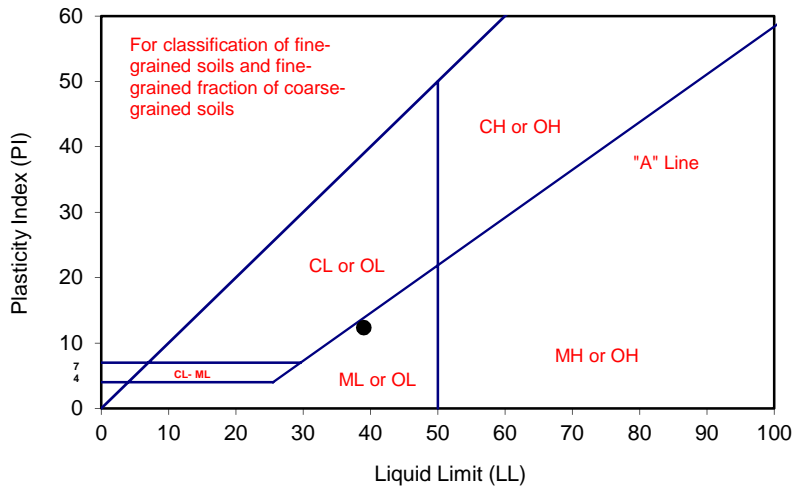

PI at "A" - Line =  $0.73(LL-20)$  13.87

One - Point Liquid Limit Calculation

$$LL = W_n(N/25)^{0.121}$$

### PROCEDURES USED

- Wet Preparation  
Multipoint - Wet
- Dry Preparation  
Multipoint - Dry
- Procedure A  
Multipoint Test
- Procedure B  
One-point Test

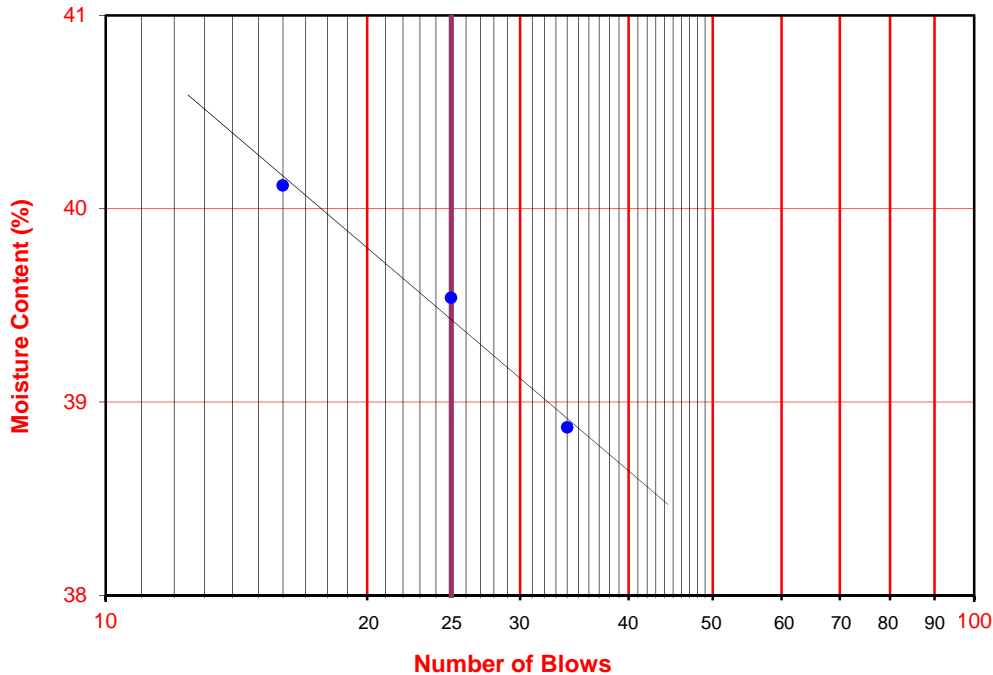



# ATTERBERG LIMITS

ASTM D 4318

Project Name: <u>San Pedro</u>	Tested By: <u>R. Manning</u>	Date: <u>08/21/17</u>
Project No. : <u>12091-01</u>	Input By: <u>G. Bathala</u>	Date: <u>08/23/17</u>
Boring No.: <u>BA-2</u>	Checked By: <u>J. Ward</u>	
Sample No.: <u>B-1</u>	Depth (ft.) <u>14.0</u>	
Soil Identification: <u>Pale yellow silt (ML)</u>		

TEST NO.	PLASTIC LIMIT		LIQUID LIMIT			
	1	2	1	2	3	4
Number of Blows [N]			35	27	20	
Wet Wt. of Soil + Cont. (g)	14.37	13.90	21.33	21.91	22.66	
Dry Wt. of Soil + Cont. (g)	12.74	12.38	18.93	19.34	19.80	
Wt. of Container (g)	7.05	7.07	13.56	13.65	13.60	
Moisture Content (%) [W <sub>n</sub> ]	28.65	28.63	44.69	45.17	46.13	

<b>Liquid Limit</b>	<b>46</b>
<b>Plastic Limit</b>	<b>29</b>
<b>Plasticity Index</b>	<b>17</b>
<b>Classification</b>	<b>ML</b>

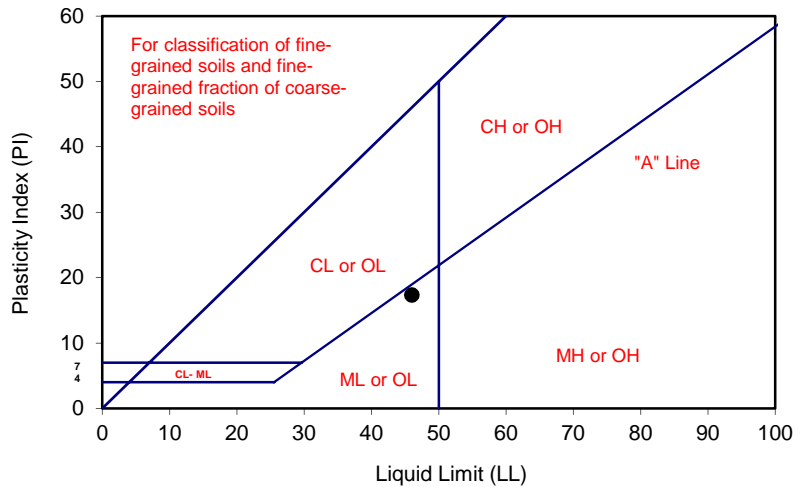

PI at "A" - Line =  $0.73(LL-20)$       18.98

One - Point Liquid Limit Calculation

$$LL = W_n(N/25)^{0.121}$$

### PROCEDURES USED

- Wet Preparation  
Multipoint - Wet
- Dry Preparation  
Multipoint - Dry
- Procedure A  
Multipoint Test
- Procedure B  
One-point Test

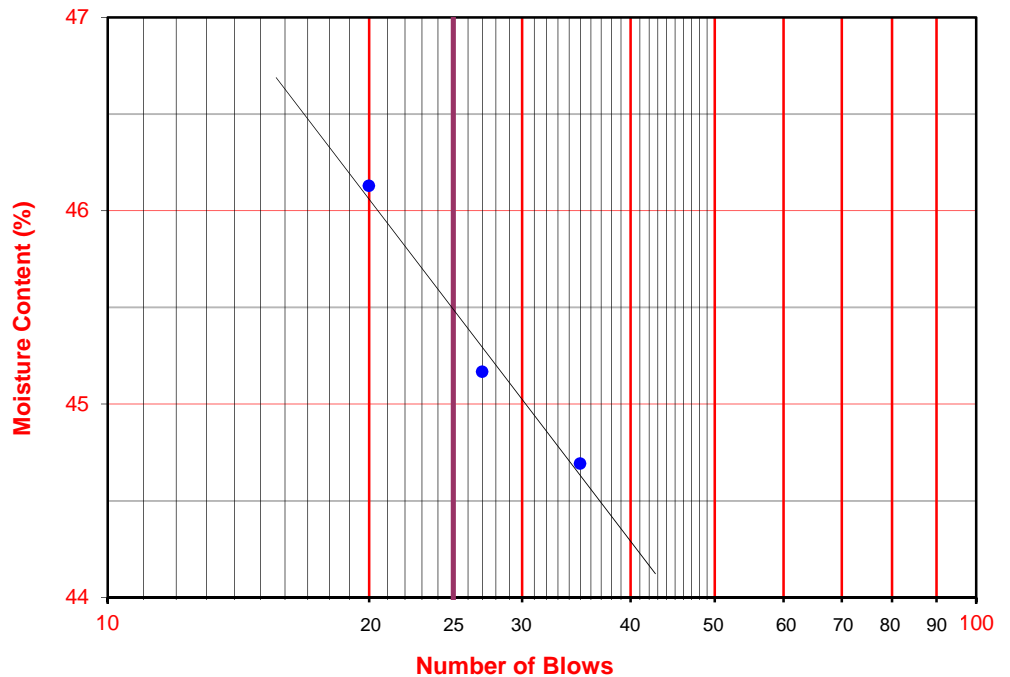



# ATTERBERG LIMITS

ASTM D 4318

Project Name: San Pedro/John S. Gibson Blvd. Tested By: R. Manning Date: 02/08/19  
 Project No. : 12091-01 Input By: G. Bathala Date: 02/12/19  
 Boring No.: BA-3 Checked By: J. Ward  
 Sample No.: R-1 Depth (ft.) 10.0  
 Soil Identification: Yellowish brown silty sand (SM)

TEST NO.	PLASTIC LIMIT		LIQUID LIMIT			
	1	2	1	2	3	4
Number of Blows [N]			7			
Wet Wt. of Soil + Cont. (g)	Cannot be rolled:		25.24 Cannot get more than 7 blows:			
Dry Wt. of Soil + Cont. (g)	NonPlastic		23.14 NonPlastic			
Wt. of Container (g)			13.56			
Moisture Content (%) [Wn]			21.92			

<b>Liquid Limit</b>	<b>NP</b>
<b>Plastic Limit</b>	<b>NP</b>
<b>Plasticity Index</b>	<b>NP</b>
<b>Classification</b>	<b>NP</b>

PI at "A" - Line =  $0.73(LL-20)$  =

One - Point Liquid Limit Calculation

$$LL = Wn(N/25)^{0.121}$$

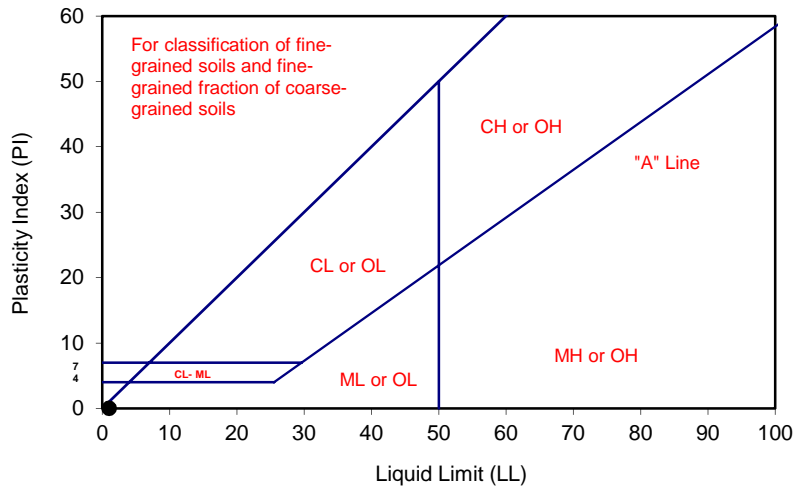

### PROCEDURES USED

- Wet Preparation  
Multipoint - Wet
- Dry Preparation  
Multipoint - Dry
- Procedure A  
Multipoint Test
- Procedure B  
One-point Test

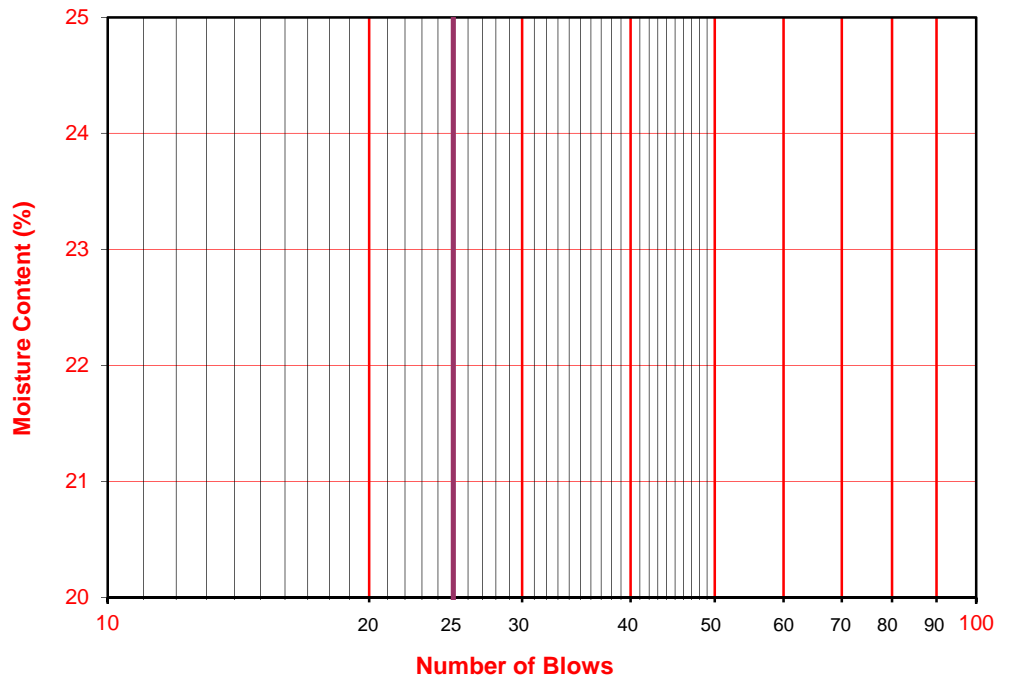





# ATTERBERG LIMITS

ASTM D 4318

Project Name: <u>San Pedro/John S. Gibson Blvd.</u>	Tested By: <u>R. Manning</u>	Date: <u>02/08/19</u>
Project No. : <u>12091-01</u>	Input By: <u>G. Bathala</u>	Date: <u>02/12/19</u>
Boring No.: <u>BA-4</u>	Checked By: <u>J. Ward</u>	
Sample No.: <u>R-1</u>	Depth (ft.) <u>3-5</u>	
Soil Identification: <u>Brown silty sand (SM)</u>		

TEST NO.	PLASTIC LIMIT		LIQUID LIMIT			
	1	2	1	2	3	4
Number of Blows [N]			8			
Wet Wt. of Soil + Cont. (g)	Cannot be rolled:		28.26	Cannot get more than 8 blows:		
Dry Wt. of Soil + Cont. (g)	NonPlastic		25.97	NonPlastic		
Wt. of Container (g)			13.78			
Moisture Content (%) [Wn]			18.79			

<b>Liquid Limit</b>	<b>NP</b>
<b>Plastic Limit</b>	<b>NP</b>
<b>Plasticity Index</b>	<b>NP</b>
<b>Classification</b>	<b>NP</b>

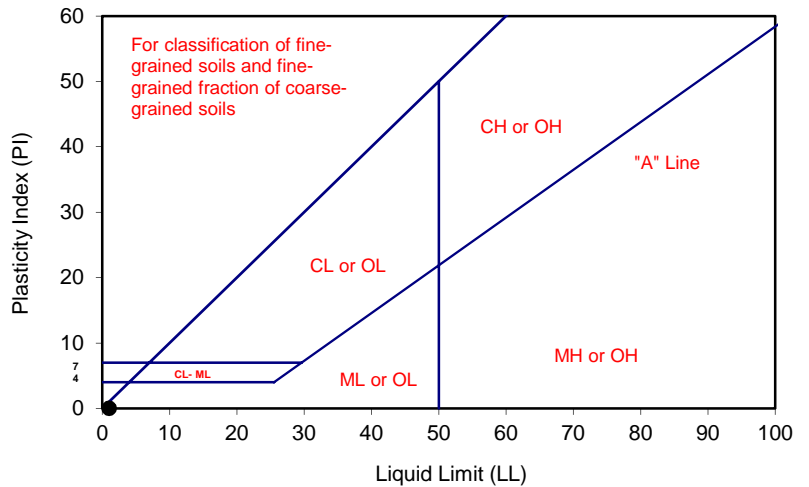

PI at "A" - Line =  $0.73(LL-20)$  =

One - Point Liquid Limit Calculation

$$LL = Wn(N/25)^{0.121}$$

### PROCEDURES USED

- Wet Preparation  
Multipoint - Wet
- Dry Preparation  
Multipoint - Dry
- Procedure A  
Multipoint Test
- Procedure B  
One-point Test

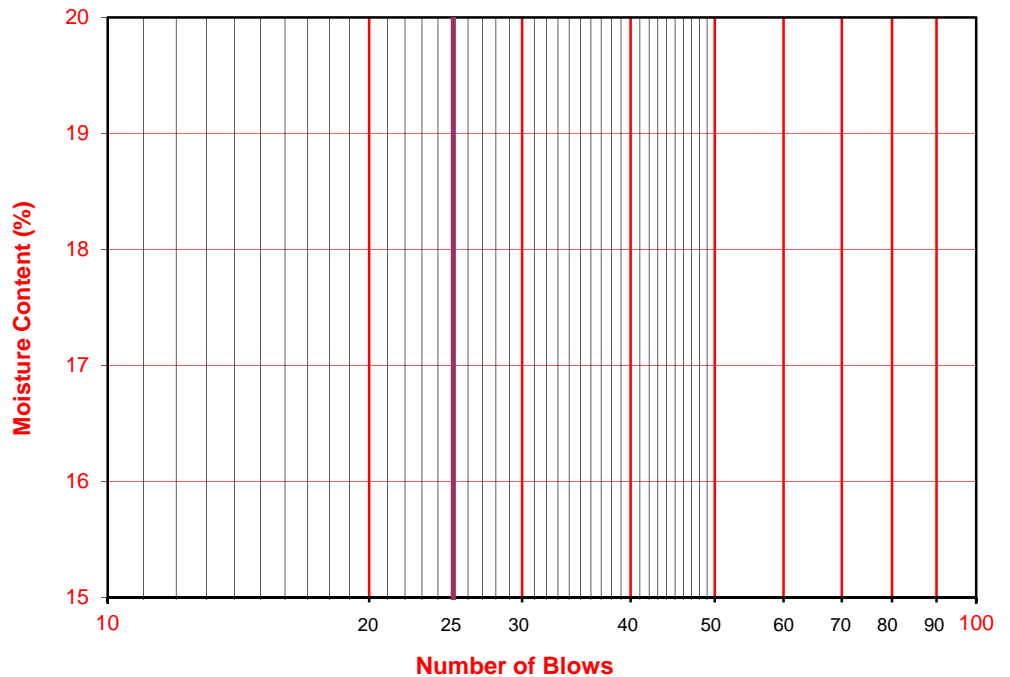



# MODIFIED PROCTOR COMPACTION TEST

ASTM D 1557

Project Name: San Pedro/John S. Gibson Blvd. Tested By: S. Dansby Date: 02/11/19  
 Project No.: 12091-01 Input By: J. Ward Date: 02/15/19  
 Boring No.: BA-1 Depth (ft.): 5-9  
 Sample No.: B-1  
 Soil Identification: Yellowish brown silty sand (SM), shells noted

Preparation Method:  Moist  Dry  Mechanical Ram  Manual Ram  
 Mold Volume (ft<sup>3</sup>) 0.03320 Ram Weight = 10 lb.; Drop = 18 in.

TEST NO.	1	2	3	4	5	6
Wt. Compacted Soil + Mold (g)	3670	3752	3782	3724		
Weight of Mold (g)	1830	1830	1830	1830		
Net Weight of Soil (g)	1840	1922	1952	1894		
Wet Weight of Soil + Cont. (g)	409.2	416.6	429.9	460.0		
Dry Weight of Soil + Cont. (g)	374.0	374.1	377.7	397.2		
Weight of Container (g)	38.7	39.6	38.8	39.5		
Moisture Content (%)	10.50	12.71	15.40	17.56		
Wet Density (pcf)	122.2	127.6	129.6	125.8		
Dry Density (pcf)	110.6	113.2	112.3	107.0		

Maximum Dry Density (pcf) 113.5 Optimum Moisture Content (%) 13.5

### PROCEDURE USED

**Procedure A**  
 Soil Passing No. 4 (4.75 mm) Sieve  
 Mold : 4 in. (101.6 mm) diameter  
 Layers : 5 (Five)  
 Blows per layer : 25 (twenty-five)  
 May be used if + #4 is 20% or less

**Procedure B**  
 Soil Passing 3/8 in. (9.5 mm) Sieve  
 Mold : 4 in. (101.6 mm) diameter  
 Layers : 5 (Five)  
 Blows per layer : 25 (twenty-five)  
 Use if + #4 is >20% and +3/8 in. is 20% or less

**Procedure C**  
 Soil Passing 3/4 in. (19.0 mm) Sieve  
 Mold : 6 in. (152.4 mm) diameter  
 Layers : 5 (Five)  
 Blows per layer : 56 (fifty-six)  
 Use if +3/8 in. is >20% and +3/4 in. is <30%

### Particle-Size Distribution:

**2:65:33**  
GR:SA:FI

**NP**  
LL,PL,PI

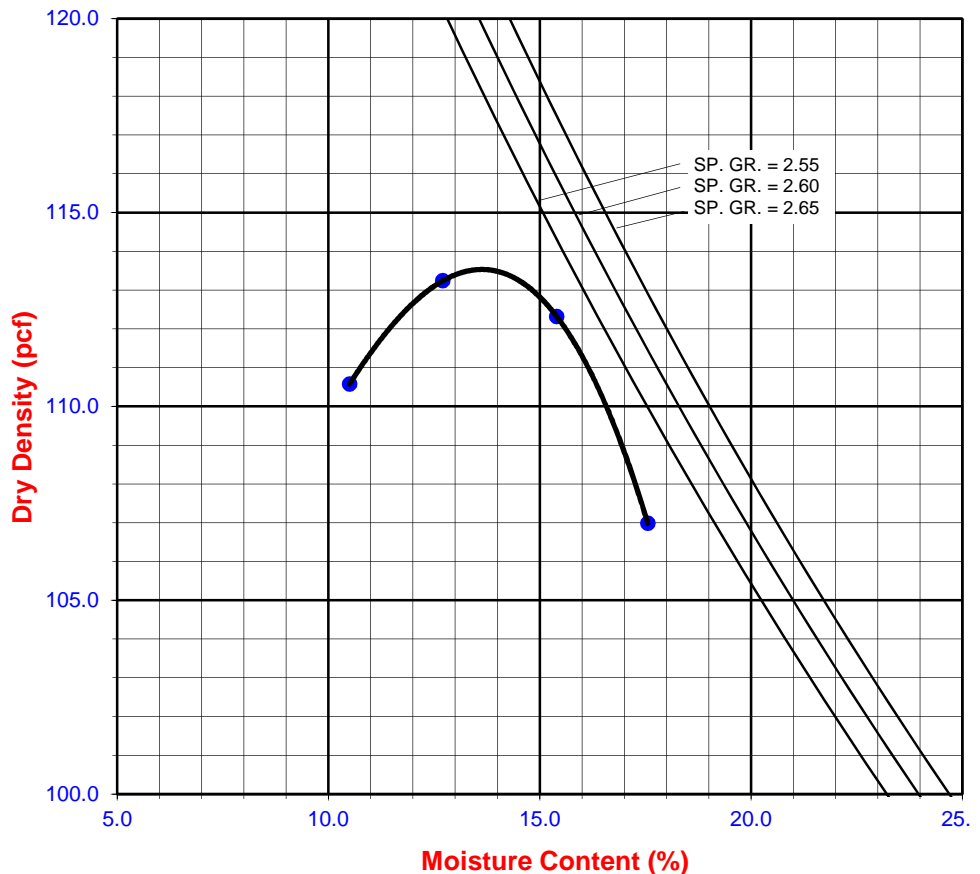



# MODIFIED PROCTOR COMPACTION TEST

ASTM D 1557

Project Name: San Pedro/John S. Gibson Blvd. Tested By: S. Dansby Date: 02/07/19  
 Project No.: 12091-01 Input By: J. Ward Date: 02/15/19  
 Boring No.: BA-3 Depth (ft.): 2-5  
 Sample No.: B-1  
 Soil Identification: Yellowish brown silty sand (SM), shells noted

Preparation Method:  Moist  Dry  Mechanical Ram  Manual Ram  
 Mold Volume (ft<sup>3</sup>) 0.03320 Ram Weight = 10 lb.; Drop = 18 in.

TEST NO.	1	2	3	4	5	6
Wt. Compacted Soil + Mold (g)	3801	3883	3950	3871		
Weight of Mold (g)	1830	1830	1830	1830		
Net Weight of Soil (g)	1971	2053	2120	2041		
Wet Weight of Soil + Cont. (g)	410.0	432.5	431.1	442.6		
Dry Weight of Soil + Cont. (g)	390.1	404.2	394.2	396.9		
Weight of Container (g)	38.5	38.4	39.4	39.5		
Moisture Content (%)	5.66	7.74	10.40	12.79		
Wet Density (pcf)	130.9	136.3	140.8	135.5		
Dry Density (pcf)	123.9	126.5	127.5	120.2		

Maximum Dry Density (pcf) 128.0 Optimum Moisture Content (%) 9.5

### PROCEDURE USED

**Procedure A**  
 Soil Passing No. 4 (4.75 mm) Sieve  
 Mold : 4 in. (101.6 mm) diameter  
 Layers : 5 (Five)  
 Blows per layer : 25 (twenty-five)  
 May be used if + #4 is 20% or less

**Procedure B**  
 Soil Passing 3/8 in. (9.5 mm) Sieve  
 Mold : 4 in. (101.6 mm) diameter  
 Layers : 5 (Five)  
 Blows per layer : 25 (twenty-five)  
 Use if + #4 is >20% and +3/8 in. is 20% or less

**Procedure C**  
 Soil Passing 3/4 in. (19.0 mm) Sieve  
 Mold : 6 in. (152.4 mm) diameter  
 Layers : 5 (Five)  
 Blows per layer : 56 (fifty-six)  
 Use if +3/8 in. is >20% and +3/4 in. is <30%

### Particle-Size Distribution:

**2:66:32**

GR:SA:FI

### Atterberg Limits:

LL,PL,PI

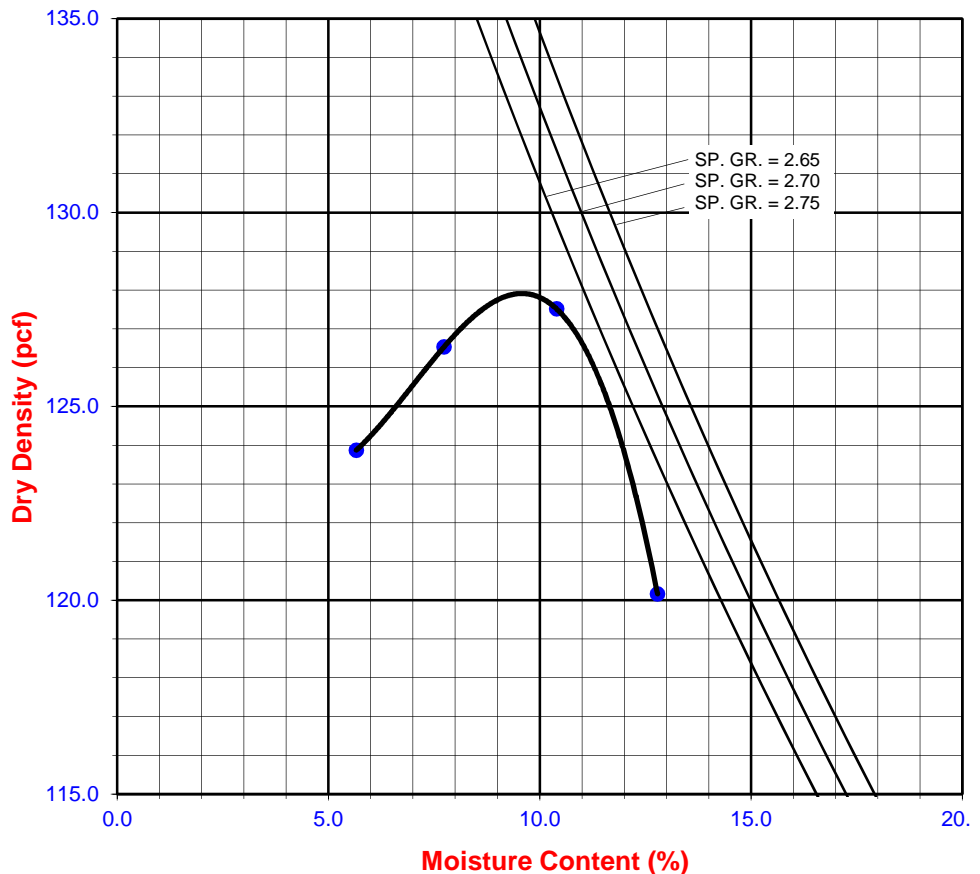



# MODIFIED PROCTOR COMPACTION TEST

ASTM D 1557

Project Name: San Pedro/John S. Gibson Blvd. Tested By: S. Dansby Date: 12/20/18  
 Project No.: 12091-01 Input By: J. Ward Date: 12/21/18  
 Boring No.: BA-4 Depth (ft.): 3-5  
 Sample No.: B-1  
 Soil Identification: Dark yellowish brown silty sand (SM)

Preparation Method:  Moist  Dry  Mechanical Ram  Manual Ram  
 Mold Volume (ft<sup>3</sup>) 0.03320 Ram Weight = 10 lb.; Drop = 18 in.

TEST NO.	1	2	3	4	5	6
Wt. Compacted Soil + Mold (g)	3786	3929	3910			
Weight of Mold (g)	1830	1830	1830			
Net Weight of Soil (g)	1956	2099	2080			
Wet Weight of Soil + Cont. (g)	518.8	502.2	497.1			
Dry Weight of Soil + Cont. (g)	495.2	468.5	454.3			
Weight of Container (g)	38.6	39.4	39.2			
Moisture Content (%)	5.17	7.85	10.31			
Wet Density (pcf)	129.9	139.4	138.1			
Dry Density (pcf)	123.5	129.2	125.2			

Maximum Dry Density (pcf) 129.0 Optimum Moisture Content (%) 8.0

### PROCEDURE USED

**Procedure A**  
 Soil Passing No. 4 (4.75 mm) Sieve  
 Mold : 4 in. (101.6 mm) diameter  
 Layers : 5 (Five)  
 Blows per layer : 25 (twenty-five)  
 May be used if + #4 is 20% or less

**Procedure B**  
 Soil Passing 3/8 in. (9.5 mm) Sieve  
 Mold : 4 in. (101.6 mm) diameter  
 Layers : 5 (Five)  
 Blows per layer : 25 (twenty-five)  
 Use if + #4 is >20% and +3/8 in. is 20% or less

**Procedure C**  
 Soil Passing 3/4 in. (19.0 mm) Sieve  
 Mold : 6 in. (152.4 mm) diameter  
 Layers : 5 (Five)  
 Blows per layer : 56 (fifty-six)  
 Use if +3/8 in. is >20% and +3/4 in. is <30%

### Particle-Size Distribution:

**3:53:44**

GR:SA:FI

### Atterberg Limits:

**NP**

LL,PL,PI

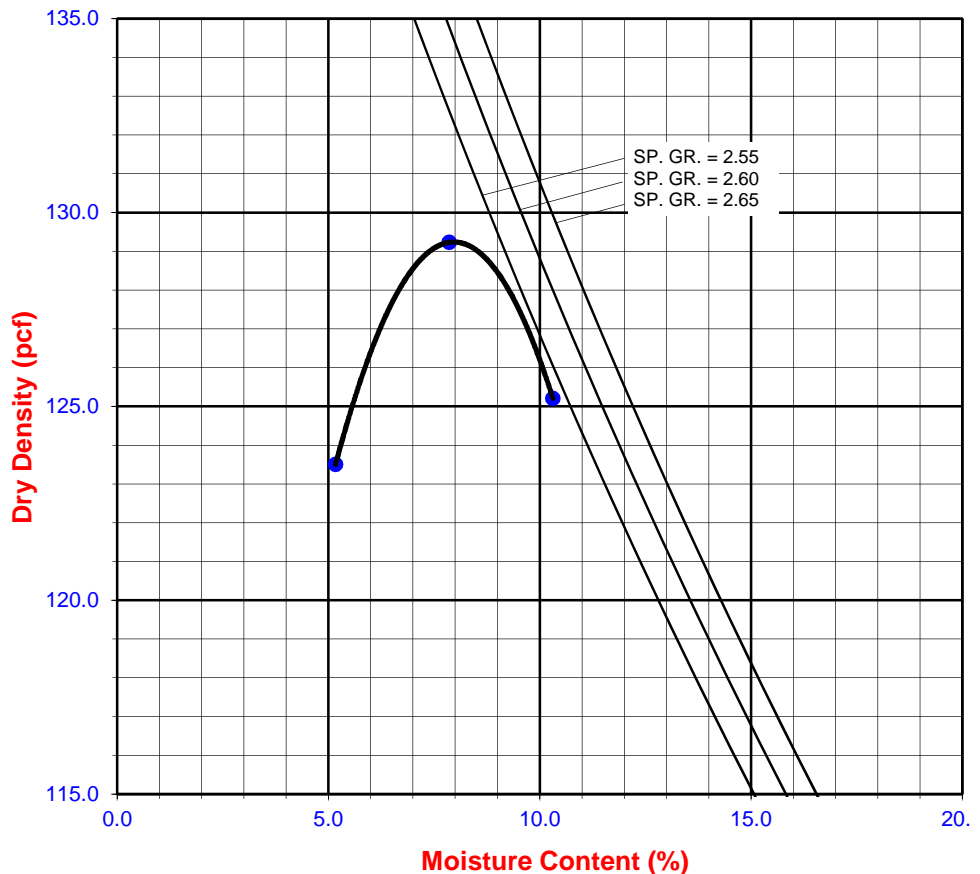



**DIRECT SHEAR TEST**  
Consolidated Drained - ASTM D 3080

Project Name: <a href="#">San Pedro/John S. Gibson Blvd.</a>	Tested By: <a href="#">G. Bathala</a>	Date: <a href="#">12/19/18</a>
Project No.: <a href="#">12091-01</a>	Checked By: <a href="#">J. Ward</a>	Date: <a href="#">01/18/19</a>
Boring No.: <a href="#">BA-3</a>	Sample Type: <a href="#">Ring</a>	
Sample No.: <a href="#">R-4</a>	Depth (ft.): <a href="#">40.0</a>	
Soil Identification: <a href="#">Light olive brown silty clay with sand (CL-ML)s</a>		

Sample Diameter(in):	2.415	2.415	2.415
Sample Thickness(in.):	1.000	1.000	1.000
Weight of Sample + ring(gm):	190.48	191.45	192.27
Weight of Ring(gm):	45.66	45.26	45.48

**Before Shearing**

Weight of Wet Sample+Cont.(gm):	212.33	212.33	212.33
Weight of Dry Sample+Cont.(gm):	182.82	182.82	182.82
Weight of Container(gm):	67.22	67.22	67.22
Vertical Rdg.(in): Initial	0.2707	0.2878	0.2276
Vertical Rdg.(in): Final	0.2795	0.3046	0.2523

**After Shearing**

Weight of Wet Sample+Cont.(gm):	204.83	207.22	206.47
Weight of Dry Sample+Cont.(gm):	169.21	170.95	173.92
Weight of Container(gm):	58.94	60.28	58.98
Specific Gravity (Assumed):	2.70	2.70	2.70
Water Density(pcf):	62.43	62.43	62.43

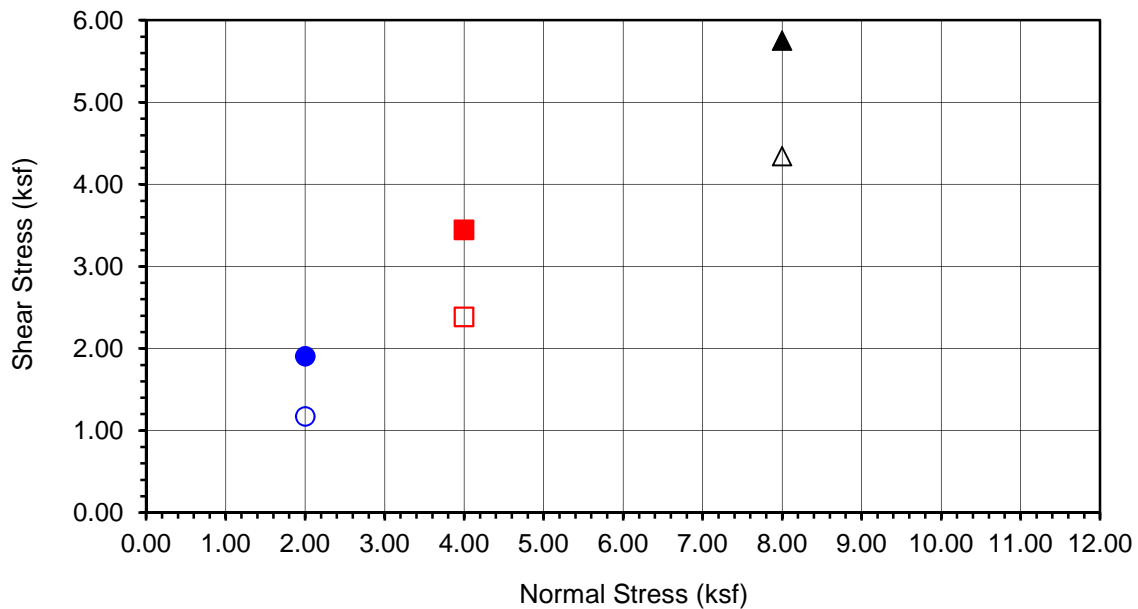
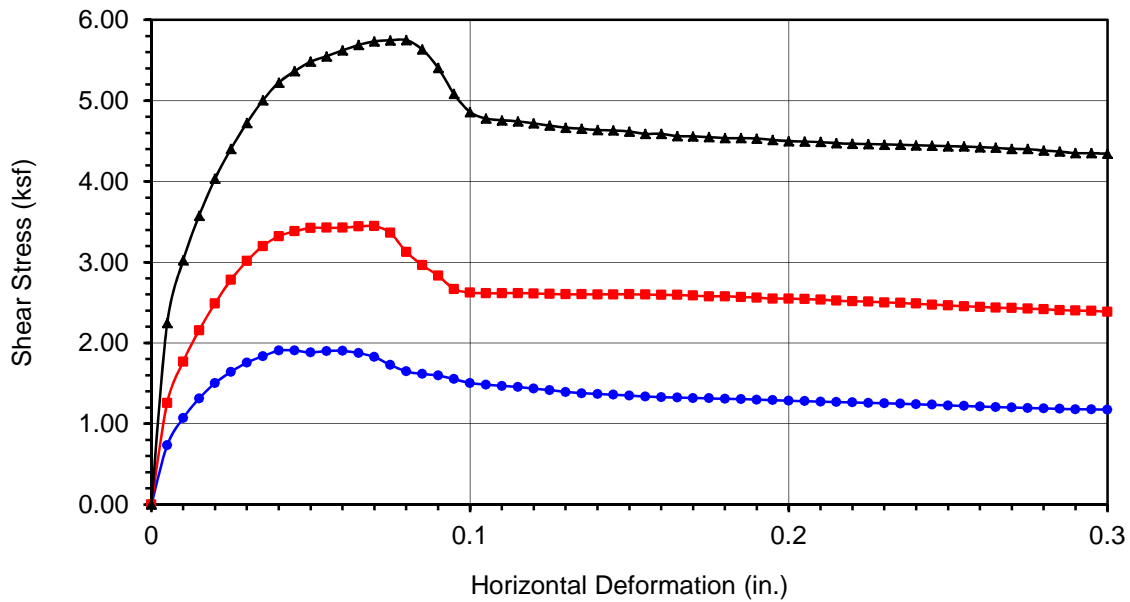

<b>Boring No.</b>	<b>BA-3</b>
<b>Sample No.</b>	<b>R-4</b>
<b>Depth (ft)</b>	<b>40</b>
<u>Sample Type:</u>	
Ring	
<u>Soil Identification:</u>	
Light olive brown silty clay with sand (CL-ML)s	

Normal Stress (kip/ft <sup>2</sup> )	2.000	4.000	8.000
Peak Shear Stress (kip/ft <sup>2</sup> )	● 1.905	■ 3.446	▲ 5.750
Shear Stress @ End of Test (ksf)	○ 1.173	□ 2.386	△ 4.342
Deformation Rate (in./min.)	0.0017	0.0017	0.0017
Initial Sample Height (in.)	1.000	1.000	1.000
Diameter (in.)	2.415	2.415	2.415
Initial Moisture Content (%)	25.53	25.53	25.53
Dry Density (pcf)	95.9	96.9	97.3
Saturation (%)	91.1	93.1	94.0
Soil Height Before Shearing (in.)	0.9912	0.9832	0.9753
Final Moisture Content (%)	32.3	32.8	28.3



Leighton

**DIRECT SHEAR TEST RESULTS**  
Consolidated Drained - ASTM D 3080

Project No.:

12091-01

San Pedro/John S. Gibson Blvd.

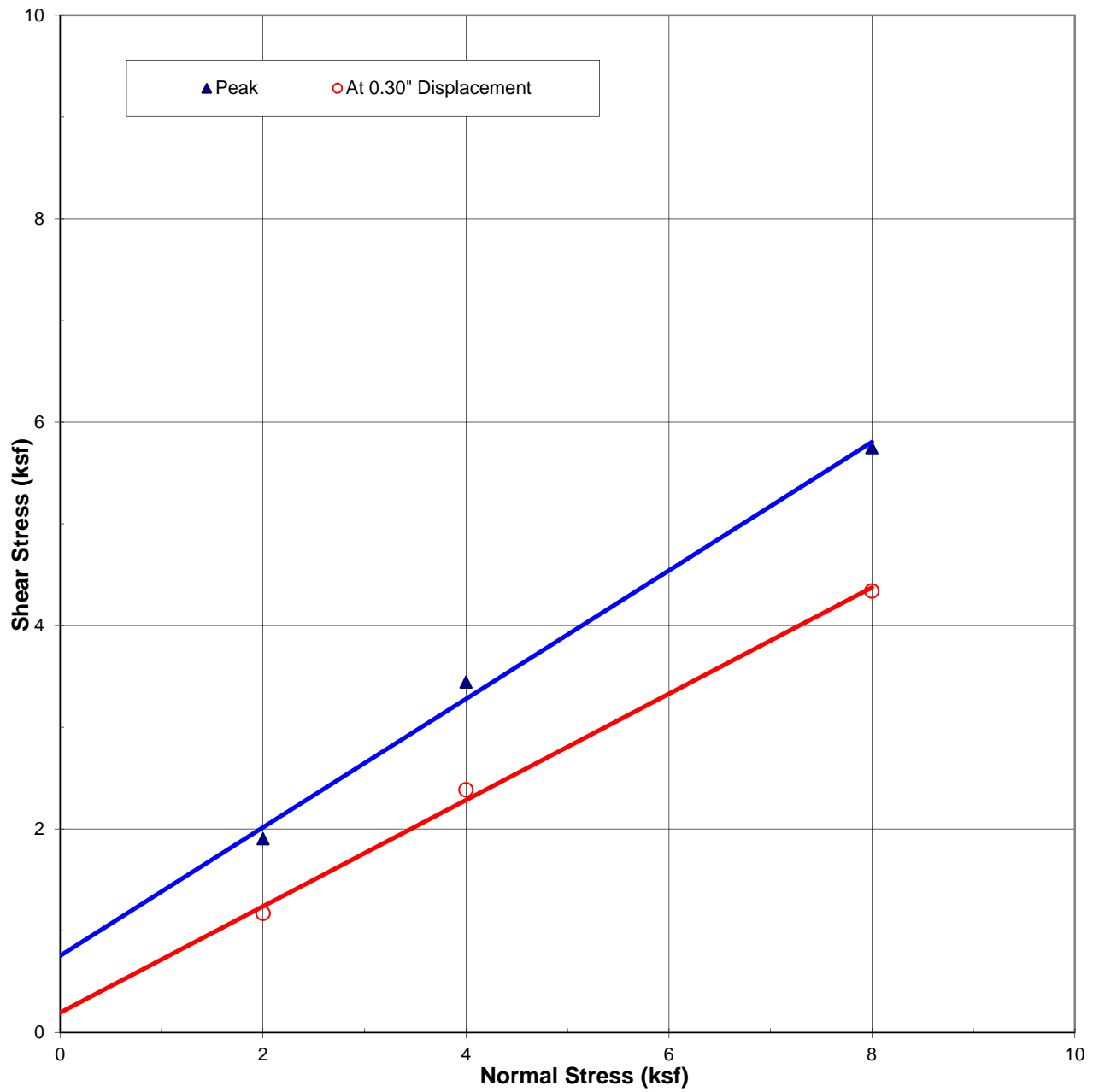

Tested Sample:  
BA-3 at 40 ft

Peak:  
32.3 Degrees  
0.75 ksf

At 0.30\"/>



**DIRECT SHEAR PLOT**

Project Number: 12091-01  
Date: Jan-19

**San Pedro**



**DIRECT SHEAR TEST**  
Consolidated Drained - ASTM D 3080

Project Name: <a href="#">San Pedro/John S. Gibson Blvd.</a>	Tested By: <a href="#">G. Bathala</a>	Date: <a href="#">12/20/18</a>
Project No.: <a href="#">12091-01</a>	Checked By: <a href="#">J. Ward</a>	Date: <a href="#">01/18/19</a>
Boring No.: <a href="#">BA-4</a>	Sample Type: <a href="#">Ring</a>	
Sample No.: <a href="#">R-1</a>	Depth (ft.): <a href="#">10.0</a>	
Soil Identification: <a href="#">Yellowish brown silty sandstone (SM), trace clay noted</a>		

Sample Diameter(in):	2.415	2.415	2.415
Sample Thickness(in.):	1.000	1.000	1.000
Weight of Sample + ring(gm):	<a href="#">180.95</a>	<a href="#">189.93</a>	<a href="#">194.13</a>
Weight of Ring(gm):	<a href="#">45.32</a>	<a href="#">45.68</a>	<a href="#">45.08</a>

**Before Shearing**

Weight of Wet Sample+Cont.(gm):	<a href="#">199.70</a>	199.70	199.70
Weight of Dry Sample+Cont.(gm):	<a href="#">191.51</a>	191.51	191.51
Weight of Container(gm):	<a href="#">57.93</a>	57.93	57.93
Vertical Rdg.(in): Initial	<a href="#">0.2726</a>	<a href="#">0.0000</a>	<a href="#">0.2591</a>
Vertical Rdg.(in): Final	<a href="#">0.2761</a>	<a href="#">-0.0045</a>	<a href="#">0.2672</a>

**After Shearing**

Weight of Wet Sample+Cont.(gm):	<a href="#">199.83</a>	<a href="#">189.68</a>	<a href="#">213.20</a>
Weight of Dry Sample+Cont.(gm):	<a href="#">179.91</a>	<a href="#">169.68</a>	<a href="#">194.26</a>
Weight of Container(gm):	<a href="#">55.81</a>	<a href="#">36.52</a>	<a href="#">57.80</a>
Specific Gravity (Assumed):	2.70	2.70	2.70
Water Density(pcf):	62.43	62.43	62.43



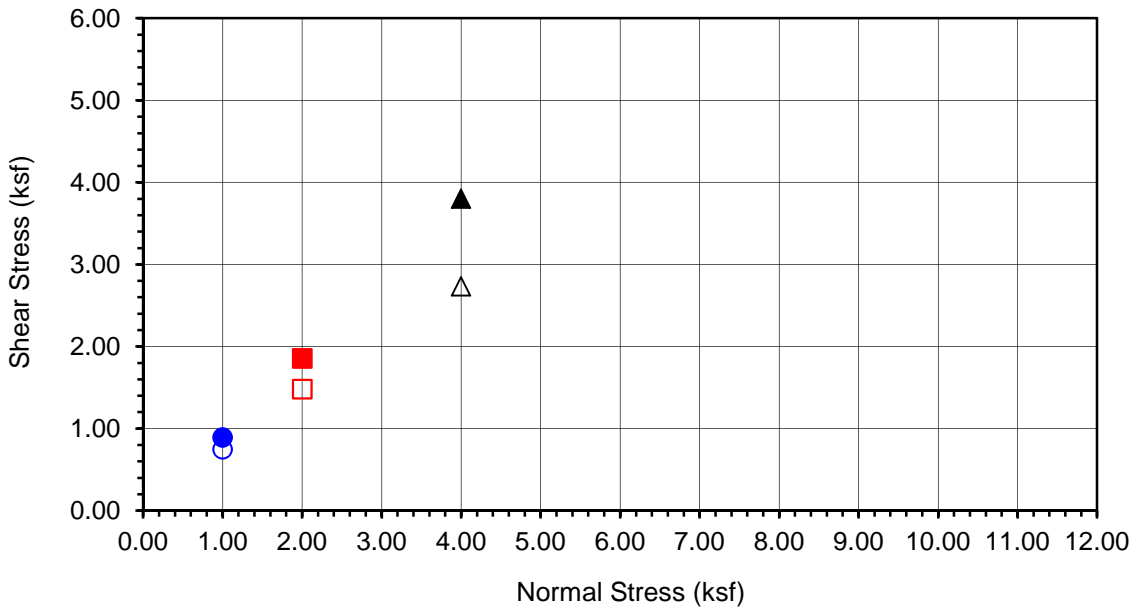
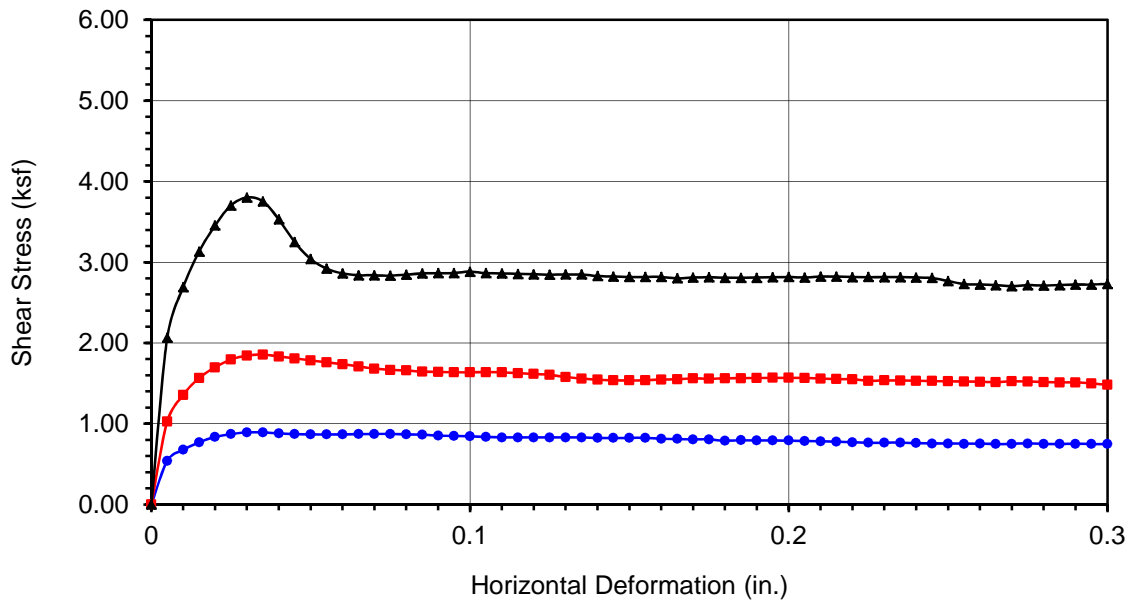

<b>Boring No.</b>	<b>BA-4</b>
<b>Sample No.</b>	<b>R-1</b>
<b>Depth (ft)</b>	<b>10</b>
<u>Sample Type:</u>	
Ring	
<u>Soil Identification:</u>	
Yellowish brown silty sandstone (SM), trace clay noted	

Normal Stress (kip/ft <sup>2</sup> )	1.000	2.000	4.000
Peak Shear Stress (kip/ft <sup>2</sup> )	● 0.893	■ 1.855	▲ 3.801
Shear Stress @ End of Test (ksf)	○ 0.748	□ 1.481	△ 2.732
Deformation Rate (in./min.)	0.0025	0.0025	0.0025
Initial Sample Height (in.)	1.000	1.000	1.000
Diameter (in.)	2.415	2.415	2.415
Initial Moisture Content (%)	6.13	6.13	6.13
Dry Density (pcf)	106.3	113.0	116.8
Saturation (%)	28.3	33.7	37.4
Soil Height Before Shearing (in.)	0.9965	0.9955	0.9919
Final Moisture Content (%)	16.1	15.0	13.9



Leighton

**DIRECT SHEAR TEST RESULTS**  
Consolidated Drained - ASTM D 3080

Project No.: 12091-01

San Pedro/John S. Gibson Blvd.

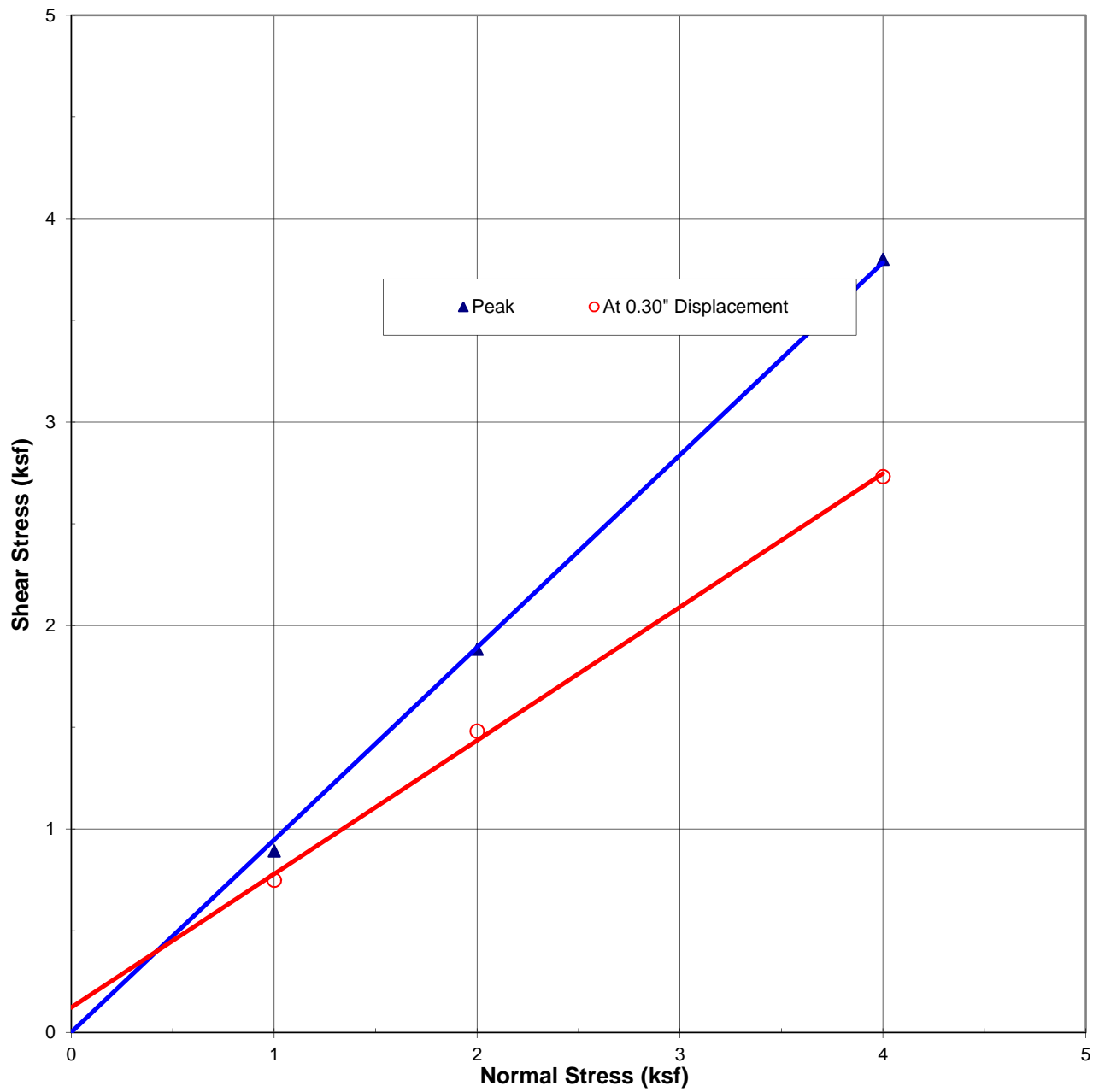

Tested Sample:  
BA-4 at 10 ft

Peak:  
44.1 Degrees  
0.00 ksf

At 0.30" Displacement:  
33.3 Degrees  
0.12 ksf



**DIRECT SHEAR PLOT**

Project Number: 12091-01  
Date: Jan-19

**San Pedro**



**DIRECT SHEAR TEST**  
Consolidated Drained - ASTM D 3080

Project Name: <a href="#">San Pedro/John S. Gibson Blvd.</a>	Tested By: <a href="#">G. Bathala</a>	Date: <a href="#">12/22/18</a>
Project No.: <a href="#">12091-01</a>	Checked By: <a href="#">J. Ward</a>	Date: <a href="#">01/18/19</a>
Boring No.: <a href="#">BA-4</a>	Sample Type: <a href="#">90% Remold</a>	
Sample No.: <a href="#">B-1</a>	Depth (ft.): <a href="#">3-5</a>	
Soil Identification: <a href="#">Dark yellowish brown silty sand (SM)</a>		

Sample Diameter(in):	2.415	2.415	2.415
Sample Thickness(in.):	1.000	1.000	1.000
Weight of Sample + ring(gm):	194.51	194.52	194.59
Weight of Ring(gm):	43.48	43.41	43.43

**Before Shearing**

Weight of Wet Sample+Cont.(gm):	195.62	195.62	195.62
Weight of Dry Sample+Cont.(gm):	186.80	186.80	186.80
Weight of Container(gm):	77.40	77.40	77.40
Vertical Rdg.(in): Initial	0.2675	0.0000	0.2727
Vertical Rdg.(in): Final	0.2741	-0.0117	0.2934

**After Shearing**

Weight of Wet Sample+Cont.(gm):	228.00	215.16	221.59
Weight of Dry Sample+Cont.(gm):	209.85	197.51	204.49
Weight of Container(gm):	71.81	58.69	65.68
Specific Gravity (Assumed):	2.70	2.70	2.70
Water Density(pcf):	62.43	62.43	62.43

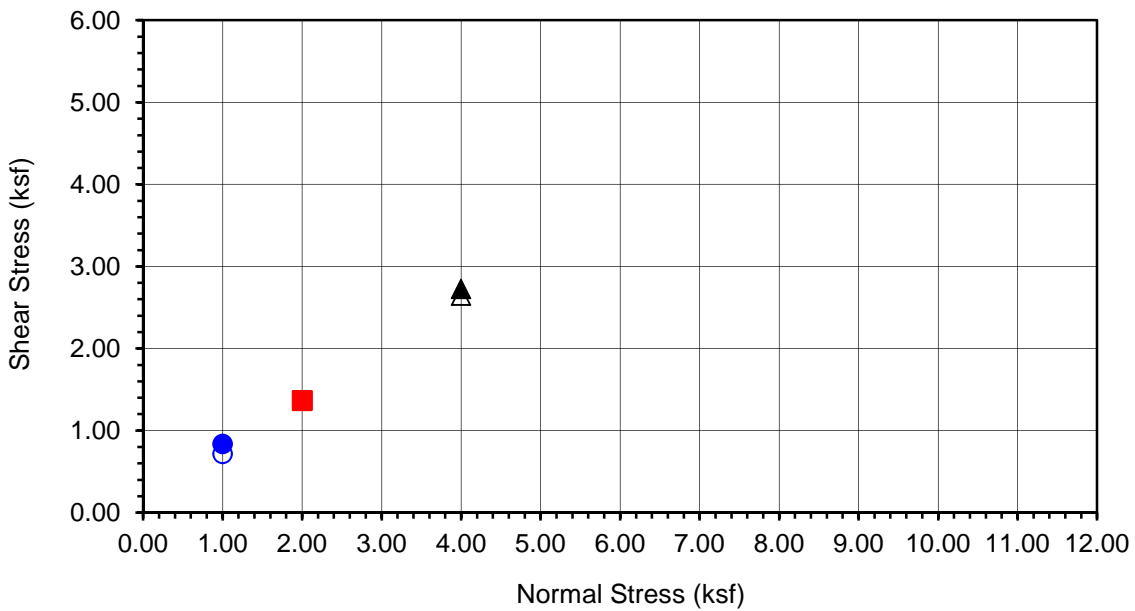
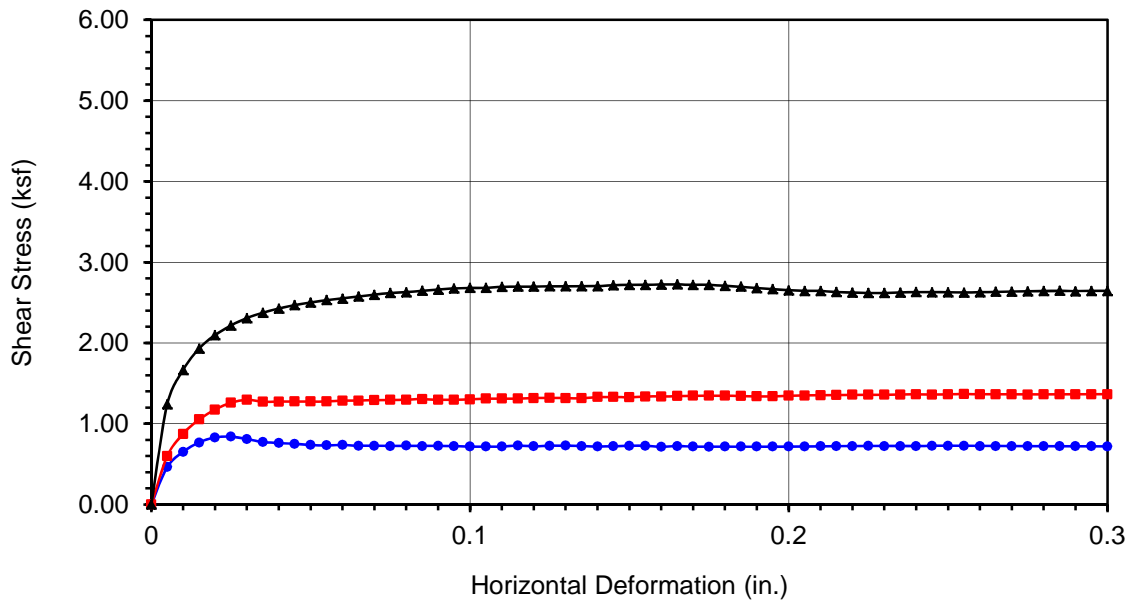

<b>Boring No.</b>	<b>BA-4</b>
<b>Sample No.</b>	<b>B-1</b>
<b>Depth (ft)</b>	<b>3-5</b>
<u>Sample Type:</u>	
90% Remold	
<u>Soil Identification:</u>	
Dark yellowish brown silty sand (SM)	

Normal Stress (kip/ft <sup>2</sup> )	1.000	2.000	4.000
Peak Shear Stress (kip/ft <sup>2</sup> )	● 0.839	■ 1.368	▲ 2.726
Shear Stress @ End of Test (ksf)	○ 0.717	□ 1.364	△ 2.644
Deformation Rate (in./min.)	0.0033	0.0033	0.0033
Initial Sample Height (in.)	1.000	1.000	1.000
Diameter (in.)	2.415	2.415	2.415
Initial Moisture Content (%)	8.06	8.06	8.06
Dry Density (pcf)	116.2	116.3	116.3
Saturation (%)	48.4	48.4	48.5
Soil Height Before Shearing (in.)	0.9934	0.9883	0.9793
Final Moisture Content (%)	13.1	12.7	12.3



Leighton

**DIRECT SHEAR TEST RESULTS**  
Consolidated Drained - ASTM D 3080

Project No.: 12091-01

San Pedro/John S. Gibson Blvd.

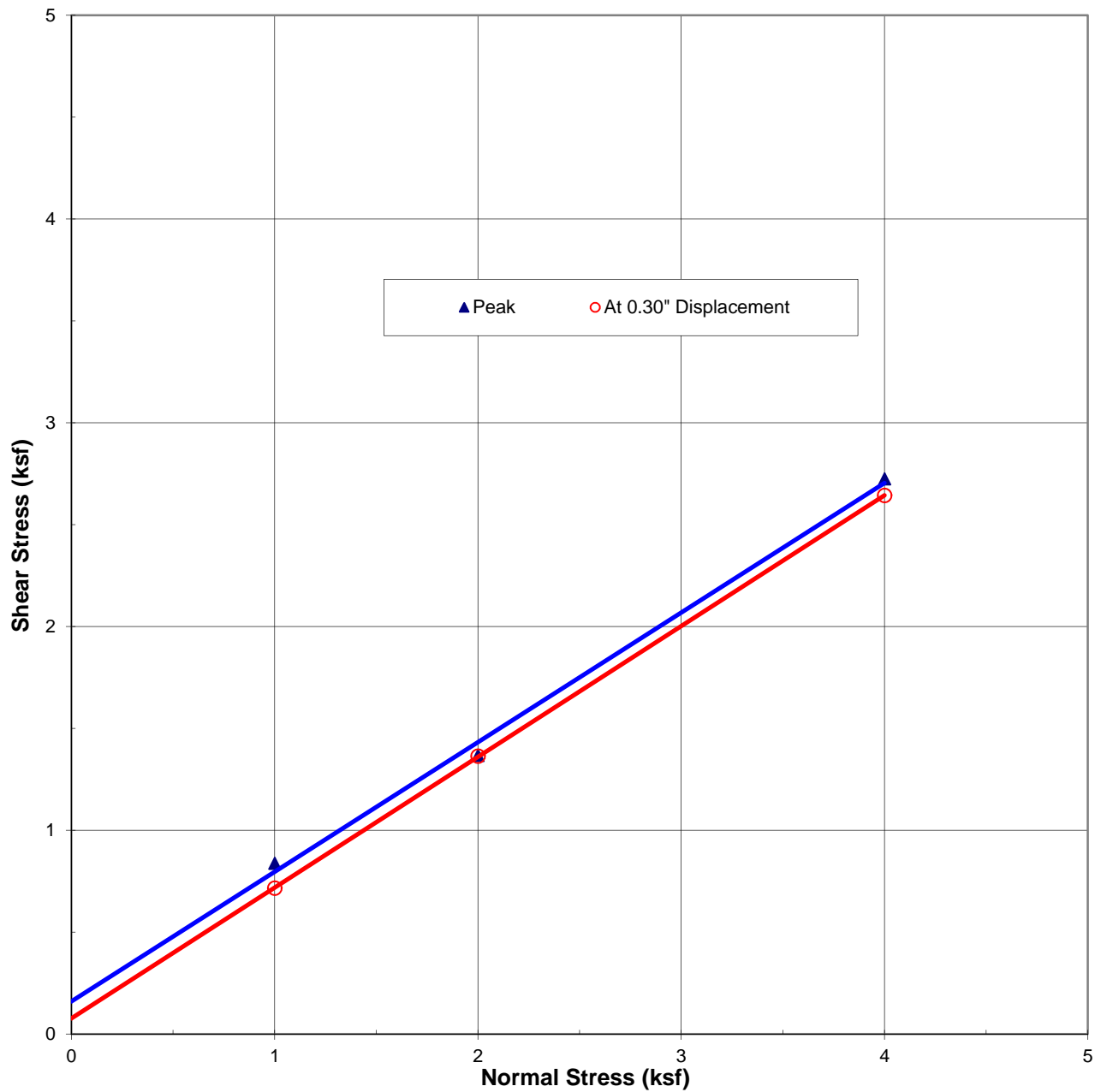

Tested Sample:  
BA-4 at 3-5 ft

Peak:  
32.5 Degrees  
0.16 ksf

At 0.30\" Displacement:  
32.7 Degrees  
0.08 ksf

Samples Remolded to 90% Relative Compaction



**DIRECT SHEAR PLOT**

Project Number: 12091-01  
Date: Jan-19

**San Pedro**



**TESTS for SULFATE CONTENT  
CHLORIDE CONTENT and pH of SOILS**

Project Name: San Pedro/John S. Gibson Blvd. Tested by : G. Berdy Date: 02/08/19  
 Project No. : 12091-01 Data Input By: J. Ward Date: 02/15/19

Boring No.	BA-1			
Sample No.	B-1			
Sample Depth (ft)	5-9			
Soil Identification:	Yellowish brown SM, shells noted			
Wet Weight of Soil + Container (g)	238.58			
Dry Weight of Soil + Container (g)	238.03			
Weight of Container (g)	56.97			
Moisture Content (%)	0.30			
Weight of Soaked Soil (g)	100.33			

**SULFATE CONTENT, DOT California Test 417, Part II**

Beaker No.	310			
Crucible No.	21			
Furnace Temperature (°C)	860			
Time In / Time Out	8:15/9:00			
Duration of Combustion (min)	45			
Wt. of Crucible + Residue (g)	22.1597			
Wt. of Crucible (g)	22.1578			
Wt. of Residue (g) (A)	0.0019			
PPM of Sulfate (A) x 41150	78.18			
<b>PPM of Sulfate, Dry Weight Basis</b>	<b>78</b>			

**CHLORIDE CONTENT, DOT California Test 422**

ml of Extract For Titration (B)	30			
ml of AgNO3 Soln. Used in Titration (C)	0.9			
PPM of Chloride (C -0.2) * 100 * 30 / B	70			
<b>PPM of Chloride, Dry Wt. Basis</b>	<b>70</b>			

**pH TEST, DOT California Test 643**

pH Value	7.36			
Temperature °C	20.9			



## SOIL RESISTIVITY TEST

### DOT CA TEST 643

Project Name: San Pedro/John S. Gibson Blvd.  
 Project No. : 12091-01  
 Boring No.: BA-1  
 Sample No. : B-1

Tested By : G. Berdy Date: 02/08/19  
 Data Input By: J. Ward Date: 02/15/19  
 Depth (ft.) : 5-9

Soil Identification:\* Yellowish brown SM, shells noted

\*California Test 643 requires soil specimens to consist only of portions of samples passing through the No. 8 US Standard Sieve before resistivity testing. Therefore, this test method may not be representative for coarser materials.

Specimen No.	Water Added (ml) (Wa)	Adjusted Moisture Content (MC)	Resistance Reading (ohm)	Soil Resistivity (ohm-cm)
1	30	23.36	2000	2000
2	40	31.04	1850	1850
3	50	38.73	1800	1800
4	60	46.41	5000	5000
5				

Moisture Content (%) (Mci)	0.30
Wet Wt. of Soil + Cont. (g)	238.58
Dry Wt. of Soil + Cont. (g)	238.03
Wt. of Container (g)	56.97
Container No.	
Initial Soil Wt. (g) (Wt)	130.53
Box Constant	1.000
$MC = (((1 + Mci/100) \times (Wa/Wt + 1)) - 1) \times 100$	

Min. Resistivity (ohm-cm)	Moisture Content (%)	Sulfate Content (ppm)	Chloride Content (ppm)	Soil pH	
				pH	Temp. (°C)
DOT CA Test 643		DOT CA Test 417 Part II		DOT CA Test 643	
<b>1560</b>	<b>36.3</b>	<b>78</b>	<b>70</b>	<b>7.36</b>	<b>20.9</b>

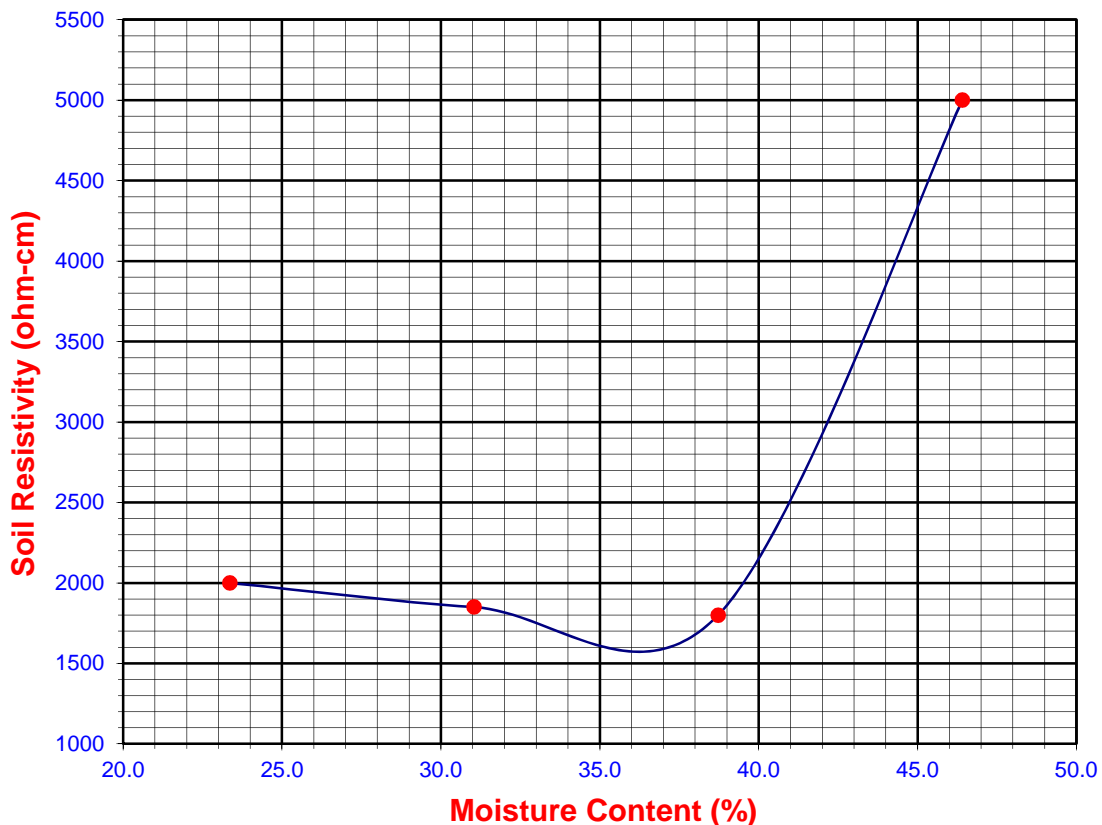



## TESTS for SULFATE CONTENT CHLORIDE CONTENT and pH of SOILS

Project Name: San Pedro/John S. Gibson Blvd. Tested By : G. Berdy Date: 12/19/18  
 Project No. : 12091-01 Data Input By: J. Ward Date: 01/18/19

Boring No.	BA-3	BA-4		
Sample No.	B-1	B-1		
Sample Depth (ft)	2-5	3-5		
Soil Identification:				
	Yellowish brown SM	Dark yellowish brown SM		
Wet Weight of Soil + Container (g)	204.83	202.38		
Dry Weight of Soil + Container (g)	198.04	200.98		
Weight of Container (g)	69.57	60.16		
Moisture Content (%)	5.29	0.99		
Weight of Soaked Soil (g)	100.06	100.10		

### SULFATE CONTENT, DOT California Test 417, Part II

Beaker No.	315	92		
Crucible No.	6	3		
Furnace Temperature (°C)	860	860		
Time In / Time Out	7:45/8:30	7:45/8:30		
Duration of Combustion (min)	45	45		
Wt. of Crucible + Residue (g)	20.7146	19.6174		
Wt. of Crucible (g)	20.7062	19.6131		
Wt. of Residue (g) (A)	0.0084	0.0043		
PPM of Sulfate (A) x 41150	345.66	176.95		
<b>PPM of Sulfate, Dry Weight Basis</b>	<b>365</b>	<b>179</b>		

### CHLORIDE CONTENT, DOT California Test 422

ml of Extract For Titration (B)	15	15		
ml of AgNO <sub>3</sub> Soln. Used in Titration (C)	0.6	0.6		
PPM of Chloride (C -0.2) * 100 * 30 / B	80	80		
<b>PPM of Chloride, Dry Wt. Basis</b>	<b>84</b>	<b>81</b>		

### pH TEST, DOT California Test 643

pH Value	8.34	7.13		
Temperature °C	22.0	22.0		





## SOIL RESISTIVITY TEST

### DOT CA TEST 643

Project Name: San Pedro/John S. Gibson Blvd.  
 Project No. : 12091-01  
 Boring No.: BA-3  
 Sample No. : B-1

Tested By : G. Berdy Date: 12/20/18  
 Data Input By: J. Ward Date: 01/18/19  
 Depth (ft.) : 2-5

Soil Identification:\* Yellowish brown SM

\*California Test 643 requires soil specimens to consist only of portions of samples passing through the No. 8 US Standard Sieve before resistivity testing. Therefore, this test method may not be representative for coarser materials.

Specimen No.	Water Added (ml) (Wa)	Adjusted Moisture Content (MC)	Resistance Reading (ohm)	Soil Resistivity (ohm-cm)
1	20	21.44	2150	2150
2	30	29.51	1700	1700
3	40	37.59	1800	1800
4				
5				

Moisture Content (%) (Mci)	5.29
Wet Wt. of Soil + Cont. (g)	204.83
Dry Wt. of Soil + Cont. (g)	198.04
Wt. of Container (g)	69.57
Container No.	
Initial Soil Wt. (g) (Wt)	130.37
Box Constant	1.000
$MC = (((1 + Mci/100) \times (Wa/Wt + 1)) - 1) \times 100$	

Min. Resistivity (ohm-cm)	Moisture Content (%)	Sulfate Content (ppm)	Chloride Content (ppm)	Soil pH	
				pH	Temp. (°C)
DOT CA Test 643		DOT CA Test 417 Part II		DOT CA Test 643	
<b>1685</b>	<b>31.0</b>	<b>365</b>	<b>84</b>	<b>8.34</b>	<b>22.0</b>

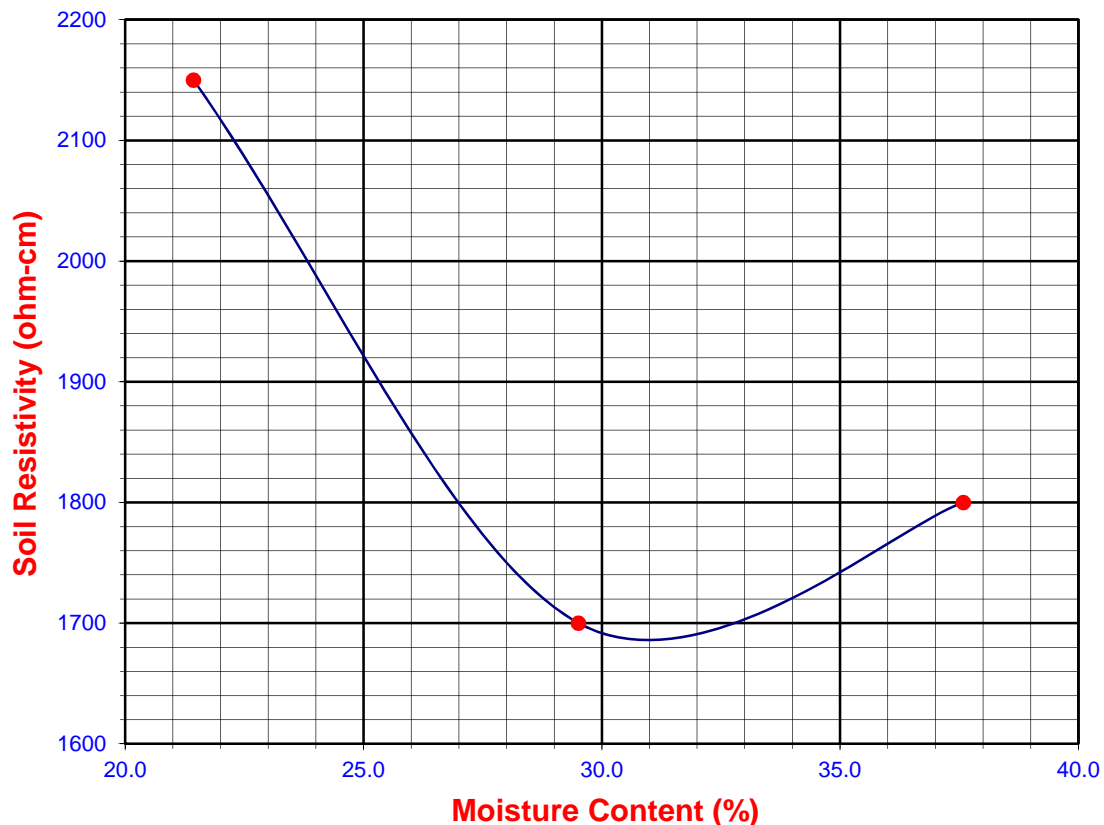



Leighton

## SOIL RESISTIVITY TEST

DOT CA TEST 643

Project Name: San Pedro/John S. Gibson Blvd.  
 Project No. : 12091-01  
 Boring No.: BA-4  
 Sample No. : B-1

Tested By : G. Berdy Date: 12/21/18  
 Data Input By: J. Ward Date: 01/18/19  
 Depth (ft.) : 3-5

Soil Identification:\* Dark yellowish brown SM

\*California Test 643 requires soil specimens to consist only of portions of samples passing through the No. 8 US Standard Sieve before resistivity testing. Therefore, this test method may not be representative for coarser materials.

Specimen No.	Water Added (ml) (Wa)	Adjusted Moisture Content (MC)	Resistance Reading (ohm)	Soil Resistivity (ohm-cm)
1	30	24.23	1350	1350
2	40	31.97	1150	1150
3	50	39.72	1100	1100
4	60	47.46	1200	1200
5				

Moisture Content (%) (Mci)	0.99
Wet Wt. of Soil + Cont. (g)	202.38
Dry Wt. of Soil + Cont. (g)	200.98
Wt. of Container (g)	60.16
Container No.	
Initial Soil Wt. (g) (Wt)	130.40
Box Constant	1.000
$MC = (((1 + Mci/100) \times (Wa/Wt + 1)) - 1) \times 100$	

Min. Resistivity (ohm-cm)	Moisture Content (%)	Sulfate Content (ppm)	Chloride Content (ppm)	Soil pH	
				pH	Temp. (°C)
DOT CA Test 643		DOT CA Test 417 Part II	DOT CA Test 422	DOT CA Test 643	
<b>1098</b>	<b>38.3</b>	<b>179</b>	<b>81</b>	<b>7.13</b>	<b>22.0</b>

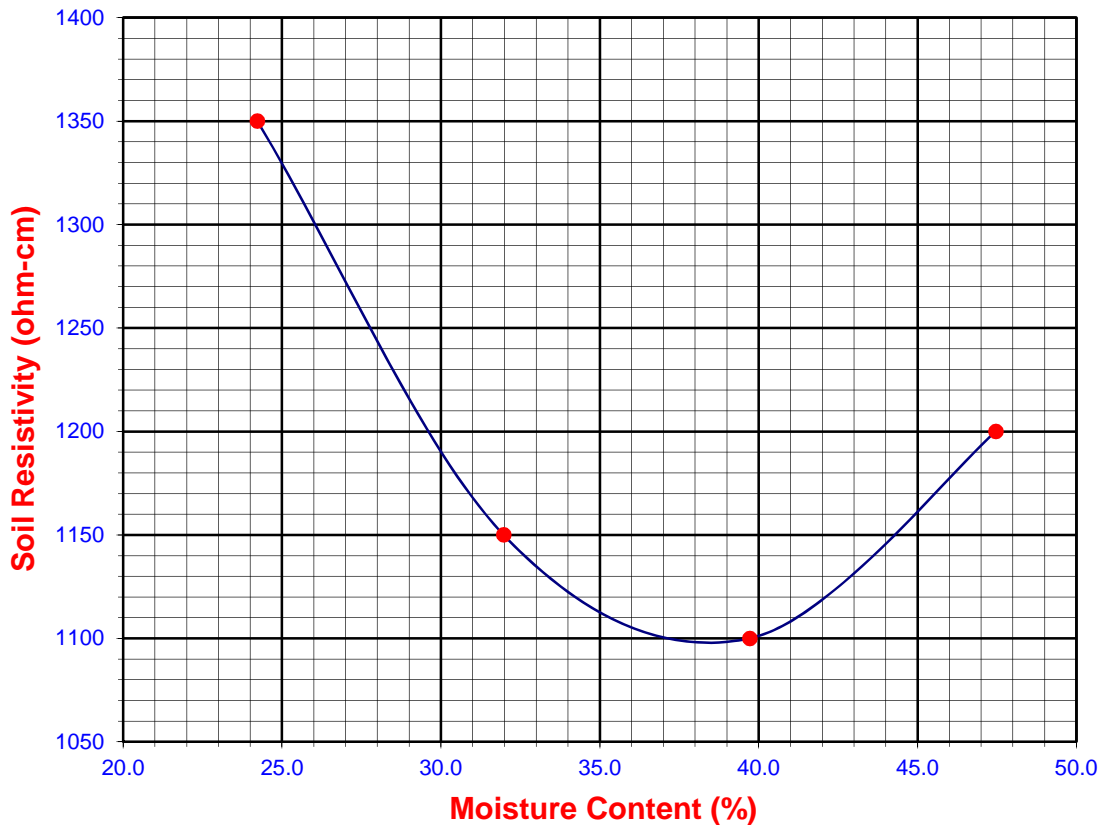

Boring No.	BA-3	BA-3	BA-3	BA-3	BA-3	BA-3	BA-4	BA-4
Sample No.	R-1	R-2	R-3	R-4	R-5	R-6	R-1	R-2
Depth (ft.)	10.0	20.0	30.0	40.0	50.0	60.0	10.0	20.0
Sample Type	Ring	Ring	Ring	Ring	Ring	Ring	Ring	Ring
Soil Identification	Yellowish brown clayey sand (SC)	Brownish yellow well-graded sand with silt (SW-SM)	Pale yellow well-graded sand with silt (SW-SM), trace clay noted	Light olive brown silty clay with sand (CL-ML)s	Light yellowish brown silt (ML)	Brown silty clay (CL-ML)	Yellowish brown silty sandstone (SM), trace clay noted	Light yellowish brown well-graded sand (SW), loose
Pocket Penetrometer (tons/ft <sup>2</sup> )	2.50	0.75	0.75	>4.50	2.75	>4.50	>4.50	N/A
Weight Soil + Rings / Tube (g)	887.9	475.7	899.0	1161.7	1067.2	1195.9	565.0	1008.2
Weight of Rings / Tube (g)	222.0	133.2	222.0	266.4	266.4	266.4	136.1	266.4
Average Length (in.)	5.00	3.00	5.00	6.00	6.00	6.00	3.00	6.00
Average Diameter (in.)	2.415	2.415	2.415	2.415	2.415	2.415	2.415	2.415
Wet. Wt. of Soil + Cont. (g)	306.21	347.80	426.29	212.33	327.98	365.08	199.70	404.00
Dry Wt. of Soil + Cont. (g)	291.91	324.62	399.56	182.82	271.17	307.72	191.51	399.97
Weight of Container (g)	39.03	37.93	39.36	67.22	38.88	39.44	57.93	38.38
Container No.								
<b>Wet Density</b>	110.8	94.9	112.6	124.1	111.0	128.8	118.9	102.8
<b>Moisture Content (%)</b>	<b>5.7</b>	<b>8.1</b>	<b>7.4</b>	<b>25.5</b>	<b>24.5</b>	<b>21.4</b>	<b>6.1</b>	<b>1.1</b>
<b>Dry Density (pcf)</b>	<b>104.8</b>	<b>87.8</b>	<b>104.8</b>	<b>98.9</b>	<b>89.2</b>	<b>106.1</b>	<b>112.0</b>	<b>101.7</b>
<b>Degree of Saturation (%)</b>	25.1	23.8	33.0	97.8	74.2	98.2	32.8	4.6

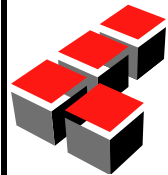

Leighton

**MOISTURE & DENSITY of SOILS**

ASTM D 2216 & ASTM D 2937

Project Name: San Pedro/John S. Gibson Blvd.

Project No.: 12091-01

Tested By: R. Manning

Date: 12/19/18

Boring No.	BA-4	BA-4	BA-4	BA-4	BA-6	BA-6	BA-6	BA-6
Sample No.	R-3	R-4	R-5	R-6	R-1	R-2	R-3	R-4
Depth (ft.)	30.0	40.0	50.0	60.0	10.0	20.0	30.0	40.0
Sample Type	Ring	Ring	Ring	Ring	Ring	Ring	Ring	Ring
Soil Identification	Light yellowish brown well-graded sand with silt (SW-SM), loose	Light gray well-graded sand with silt (SW-SM), loose	Light brownish yellow well-graded sand with silt (SW-SM)	Light brownish yellow well-graded sand with silt (SW-SM)	Light yellowish brown well-graded sand with silt (SW-SM)	Light gray well-graded sand (SW), loose	Light yellowish brown well-graded sand (SW)	Yellowish brown silty sand (SM)
Pocket Penetrometer (tons/ft <sup>2</sup> )	N/A	N/A	1.75	1.50	N/A	N/A	1.00	1.75
Weight Soil + Rings / Tube (g)	1078.4	1051.8	1083.2	1034.0	-	1045.2	1099.9	1089.0
Weight of Rings / Tube (g)	266.4	266.4	266.4	266.4	-	266.4	266.4	266.4
Average Length (in.)	6.00	6.00	6.00	6.00	-	6.00	6.00	6.00
Average Diameter (in.)	2.415	2.415	2.415	2.415	-	2.415	2.415	2.415
Wet. Wt. of Soil + Cont. (g)	314.21	311.11	331.14	298.95	362.16	416.63	460.56	406.78
Dry Wt. of Soil + Cont. (g)	306.32	303.48	305.45	279.74	344.62	405.17	446.56	386.63
Weight of Container (g)	39.30	40.08	39.75	38.36	37.45	39.28	39.26	38.95
Container No.								
<b>Wet Density</b>	112.6	108.9	113.2	106.4	-	107.9	115.5	114.0
<b>Moisture Content (%)</b>	<b>3.0</b>	<b>2.9</b>	<b>9.7</b>	<b>8.0</b>	<b>5.7</b>	<b>3.1</b>	<b>3.4</b>	<b>5.8</b>
<b>Dry Density (pcf)</b>	<b>109.3</b>	<b>105.8</b>	<b>103.2</b>	<b>98.6</b>	-	<b>104.7</b>	<b>111.7</b>	<b>107.8</b>
<b>Degree of Saturation (%)</b>	14.7	13.2	41.3	30.2	-	13.9	18.2	27.7

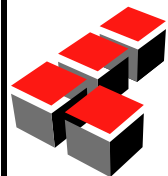

Leighton

**MOISTURE & DENSITY of SOILS**

ASTM D 2216 & ASTM D 2937

Project Name: San Pedro/John S. Gibson Blvd.

Project No.: 12091-01

Tested By: R. Manning

Date: 12/19/18

Boring No.	BA-6	BA-6						
Sample No.	R-5	R-6						
Depth (ft.)	50.0	60.0						
Sample Type	Ring	Ring						
Soil Identification	Yellowish brown lean clay (CL)	Gray silty clay (CL-ML)						
Pocket Penetrometer (tons/ft <sup>2</sup> )	>4.50	>4.50						
Weight Soil + Rings / Tube (g)	961.2	758.7						
Weight of Rings / Tube (g)	222.0	177.6						
Average Length (in.)	5.00	4.00						
Average Diameter (in.)	2.415	2.415						
Wet. Wt. of Soil + Cont. (g)	321.70	354.50						
Dry Wt. of Soil + Cont. (g)	258.29	280.66						
Weight of Container (g)	39.33	37.54						
Container No.								
<b>Wet Density</b>	123.0	120.8						
<b>Moisture Content (%)</b>	<b>29.0</b>	<b>30.4</b>						
<b>Dry Density (pcf)</b>	<b>95.3</b>	<b>92.7</b>						
<b>Degree of Saturation (%)</b>	101.8	100.1						

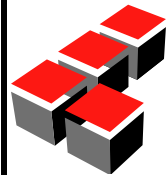

Leighton

**MOISTURE & DENSITY of SOILS**

ASTM D 2216 & ASTM D 2937

Project Name: San Pedro/John S. Gibson Blvd.

Project No.: 12091-01

Tested By: R. Manning

Date: 12/19/18

*From Lawson, 2005*

*Appendix C*  
*Laboratory Test Results*

## APPENDIX C

### Laboratory Testing Procedures and Test Results

The laboratory test program was formulated towards providing quantitative data relating to the relevant engineering properties of the anticipated site soil conditions. Samples considered representative of site conditions were tested per American Society for Testing and Materials (ASTM) procedure and/or California Test Methods (CTM), where applicable. The following summary is a brief outline of the test type and a table summarizing the test results.

Soil Classification: Soils were visually and texturally classified according the Unified Soil Classification System (USCS) in accordance with ASTM Test Methods D2487 and D2488. This system uses relies on the Atterberg Limits and grain size distribution of a soil. The soil classifications (or group symbol) are shown on the laboratory test data and boring logs.

Moisture and Density Determination Tests: Moisture content (ASTM D2216) and dry density determinations (ASTM D2937) were performed on relatively undisturbed samples obtained from the test borings and test pits. The results of these tests are presented in the boring logs.

Grain Size Distribution: Representative samples were dried, weighed, and soaked in water until individual soil particles were separated (per ASTM D421) and then washed on a No. 200 sieve. The portion retained on the No. 200 sieve was dried and then sieved on a U.S. Standard brass sieve set in accordance with ASTM D422 (CTM 202). Gradation curves are provided in this Appendix.

Atterberg Limits: The liquid and plastic limits (“Atterberg Limits”) were determined in accordance with ASTM Test Method D4318 for engineering classification of fine-grained material. The plasticity charts are presented in this Appendix.

Expansion Index: The expansion potential of selected samples were evaluated by the Expansion Index Test, CBC Standard No. 18-2 and/or ASTM D4829. Specimens are molded under a given compactive energy to approximately the optimum moisture content and approximately 50 percent saturation or approximately 90 percent relative compaction. The prepared 1-inch-thick by 4-inch-diameter specimens are loaded to an equivalent 144 psf surcharge and are inundated with tap water until volumetric equilibrium is reached. The results of these tests are presented in the table below:

Sample Location	Expansion Index	Expansion Potential*
LGC-2 @ 11-13'	15	Very Low

\* Per Table 18A-1-B of 2001 CBC.

Maximum Density Test (Laboratory Compaction): The maximum dry density and optimum moisture content of typical materials were determined in accordance with ASTM D1557. The results of these tests are presented in the table below:

Sample Location	Sample Description	Maximum Dry Density (pcf)	Optimum Moisture Content (%)
LGC-1 @ 7-9'	Olive Silty Sand	105.0	11.5



## APPENDIX C

### Laboratory Testing Procedures and Test Results (Continue)

Consolidation: Consolidation tests were performed on selected, relatively undisturbed ring samples (Modified ASTM Test Method D2435). Samples (2.42 inches in diameter and 1 inch in height) were placed in a consolidometer and increasing loads were applied. The samples were allowed to consolidate under “double drainage” and total deformation for each loading step was recorded. The percent consolidation for each load step was recorded as the ratio of the amount of vertical compression to the original sample height. The plots are provided in this Appendix.

Direct Shear: Direct shear tests were performed on a selected remolded sample, which were soaked for a minimum of 24 hours under a surcharge equal to the applied normal force during testing. After transfer of the sample to the shear box, and reloading the sample, pore pressures set up in the sample due to the transfer were allowed to dissipate for a period of approximately 1 hour prior to application of shearing force. The samples were tested under various normal loads, a motor-driven, strain-controlled, direct-shear testing apparatus. The test plot is provided in this Appendix.

Soluble Sulfates: The soluble sulfate contents of selected samples were determined by standard geochemical methods (CTM 417). The soluble sulfate content is used to determine the appropriate cement type and maximum water-cement ratios. The test results are presented in the table below:

Sample Location	Sulfate Content (%)*	Sulfate Exposure**
LGC-2 @ 11-13'	.008	Negligible

\*Expressed as the percentage of water-soluble sulfate ( $SO_4$ ) in soil, percentage by weight.

\*\* Based on the 2001 edition of the California Building Code (CBC), Table No. 19A-A-4.

Minimum Resistivity and pH Tests: Minimum resistivity and pH tests were performed in general accordance with CTM 643 and standard geochemical methods. The electrical resistivity of a soil is a measure of its resistance to the flow of electrical current. As a results of soil's resistivity decreases corrosivity increases. The results are presented in the table below:

Sample Location	pH	Minimum Resistivity (ohms-cm)
LGC-2 @ 11-13'	8.2	5,100

Chloride Content: Chloride content was tested in accordance with California Test Method (CTM) 422. The results are presented below:

Sample Location	Chloride Content, ppm
LGC-2 @ 11-13'	33

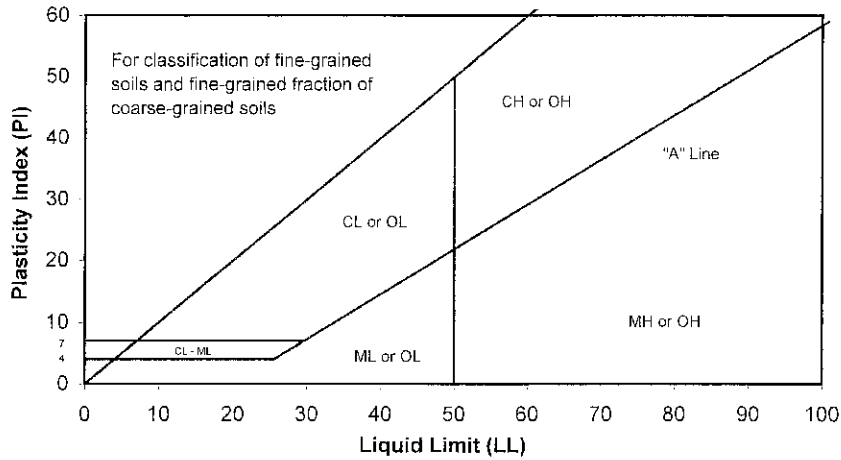

GRAVEL			SAND			FINES				
COARSE	FINE		CRSE	MEDIUM	FINE	SILT				
U.S. STANDARD SIEVE OPENING			U.S. STANDARD SIEVE NUMBER			HYDROMETER				
3.0"	1 1/2"	3/4"	3/8"	#4	#8	#16	#30	#50	#100	#200

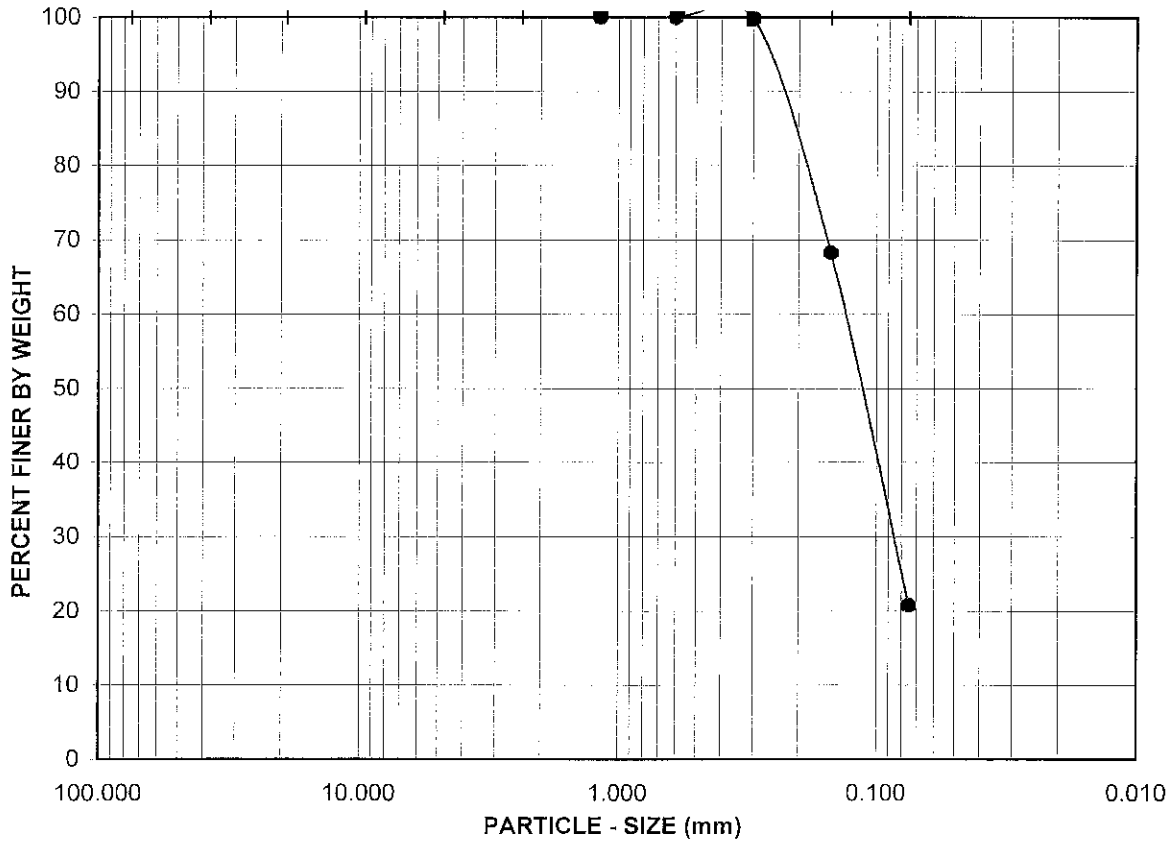

Boring No.:	Sample No.:	Depth (ft.):	Soil Type	GR:SA:FI	LL,PL,PI
LGC-1	R-3	20	SM	0:79:21	NonPlastic,,

Soil Description: Olive silty fine sand (SM)



**ATTERBERG LIMITS,  
PARTICLE - SIZE CURVE  
ASTM D 4318, D 422**

Project No.: 041104-01

San Pedro - Self Storage



# ATTERBERG LIMITS

ASTM D 4318

Project Name: San Pedro - Self Storage      Tested By: RA      Date: 09/29/04  
 Project No. : 041104-01      Input By: LF      Date: 10/01/04  
 Boring No.: LGC-1      Checked By: LF  
 Sample No.: R-3      Depth (ft.) 20.0  
 Soil Identification: Olive silty fine sand (SM)

TEST NO.	PLASTIC LIMIT		LIQUID LIMIT			
	1	2	1	2	3	4
Number of Blows [N]			6			
Wet Wt. of Soil + Cont. (g)	Cannot be rolled		21.04	Cannot get >6 blows		
Dry Wt. of Soil + Cont. (g)	NonPlastic		16.53	NonPlastic		
Wt. of Container (g)			1.04			
Moisture Content (%) [W <sub>n</sub> ]			29.12			

<b>Liquid Limit</b>	<b>NP</b>
<b>Plastic Limit</b>	<b>NP</b>
<b>Plasticity Index</b>	<b>NP</b>
<b>Classification</b>	<b>NP</b>

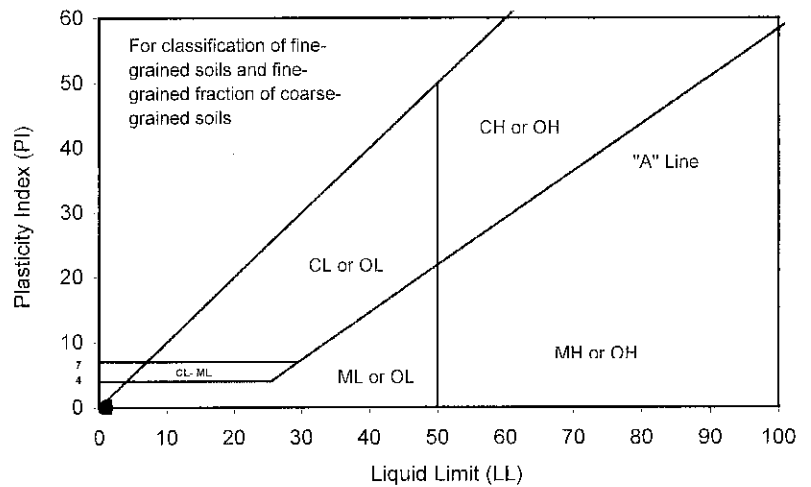

PI at "A" - Line =  $0.73(LL-20)$  #VALUE!

One - Point Liquid Limit Calculation

$$LL = W_n(N/25)^{0.12}$$

## PROCEDURES USED

- Wet Preparation  
Multipoint - Wet
- Dry Preparation  
Multipoint - Dry
- Procedure A  
Multipoint Test
- Procedure B  
One-point Test

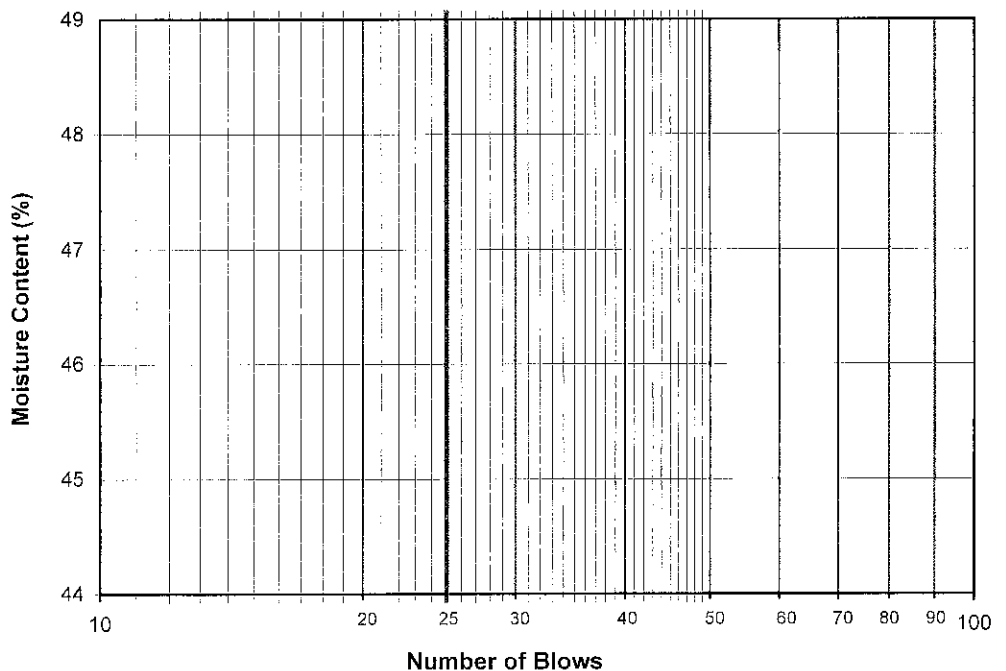

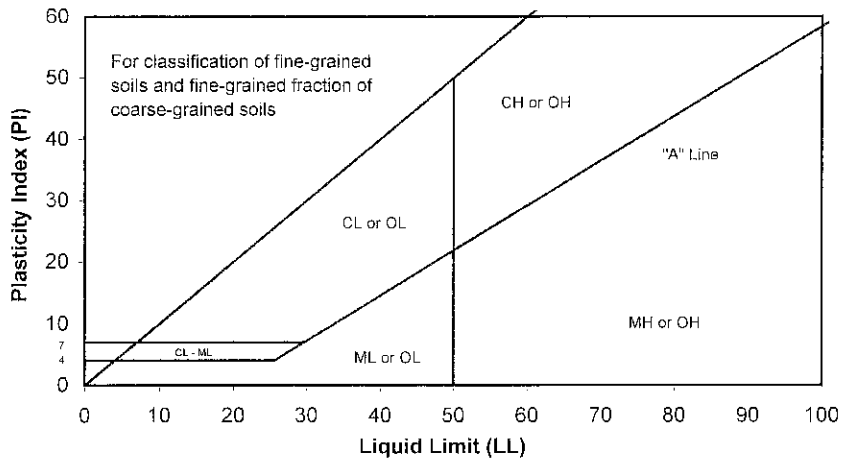

GRAVEL				SAND			FINES			
COARSE		FINE		CRSE	MEDIUM	FINE	SILT			
U.S. STANDARD SIEVE OPENING				U.S. STANDARD SIEVE NUMBER			HYDROMETER			
3.0"	1 1/2"	3/4"	3/8"	#4	#8	#16	#30	#50	#100	#200

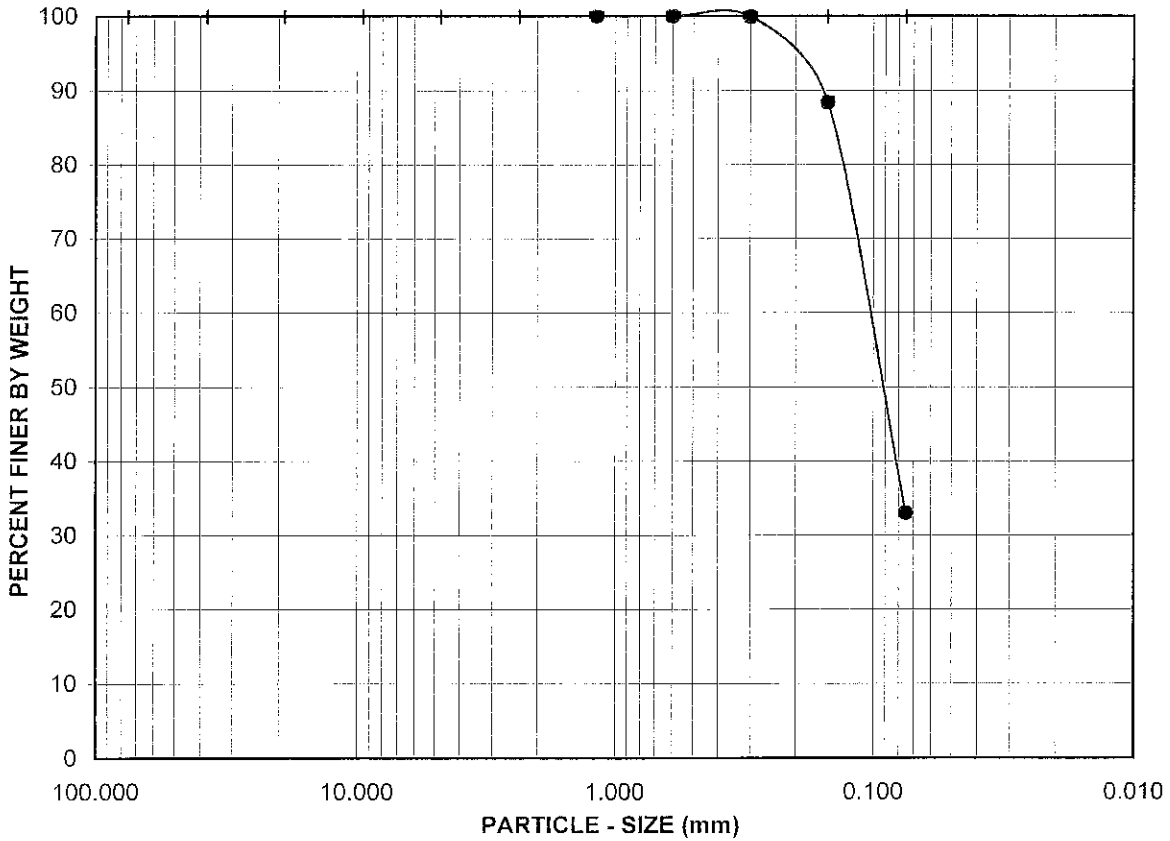

Boring No.:	Sample No.:	Depth (ft.):	Soil Type	GR:SA:FI	LL,PL,PI
LGC-3	R-2	10	SM	0:67:33	NonPlastic,,

Soil Description: Yellowish brown silty fine sand (SM)



**ATTERBERG LIMITS,  
PARTICLE - SIZE CURVE  
ASTM D 4318, D 422**

Project No.: 041104-01

San Pedro - Self Storage



# ATTERBERG LIMITS

ASTM D 4318

Project Name: San Pedro - Self Storage      Tested By: RA      Date: 09/29/04  
 Project No. : 041104-01      Input By: LF      Date: 10/01/04  
 Boring No.: LGC-3      Checked By: LF  
 Sample No.: R-2      Depth (ft.) 10.0  
 Soil Identification: Yellowish brown silty fine sand (SM)

TEST NO.	PLASTIC LIMIT		LIQUID LIMIT			
	1	2	1	2	3	4
Number of Blows [N]			10			
Wet Wt. of Soil + Cont. (g)	Cannot be rolled		20.81	Cannot get >10 blows		
Dry Wt. of Soil + Cont. (g)	NonPlastic		16.52	NonPlastic		
Wt. of Container (g)			1.13			
Moisture Content (%) [W <sub>n</sub> ]			27.88			

<b>Liquid Limit</b>	<b>NP</b>
<b>Plastic Limit</b>	<b>NP</b>
<b>Plasticity Index</b>	<b>NP</b>
<b>Classification</b>	<b>NP</b>

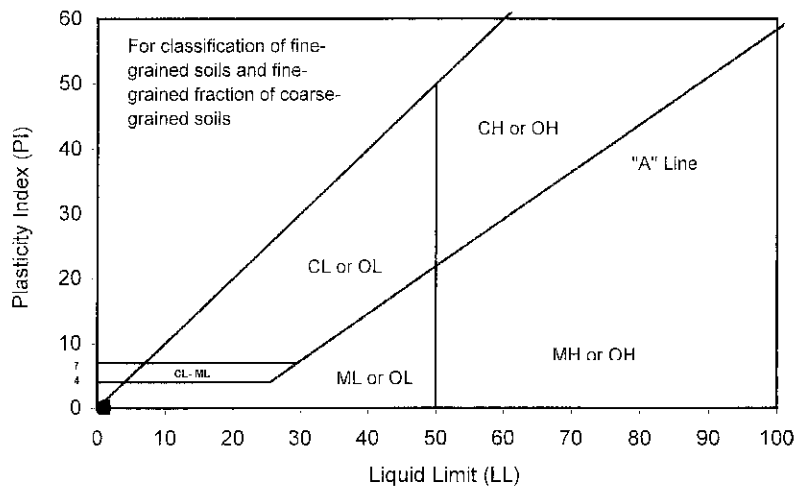

PI at "A" - Line =  $0.73(LL-20)$  #VALUE!

One - Point Liquid Limit Calculation

$$LL = W_n(N/25)^{0.12}$$

### PROCEDURES USED

- Wet Preparation  
Multipoint - Wet
- Dry Preparation  
Multipoint - Dry
- Procedure A  
Multipoint Test
- Procedure B  
One-point Test

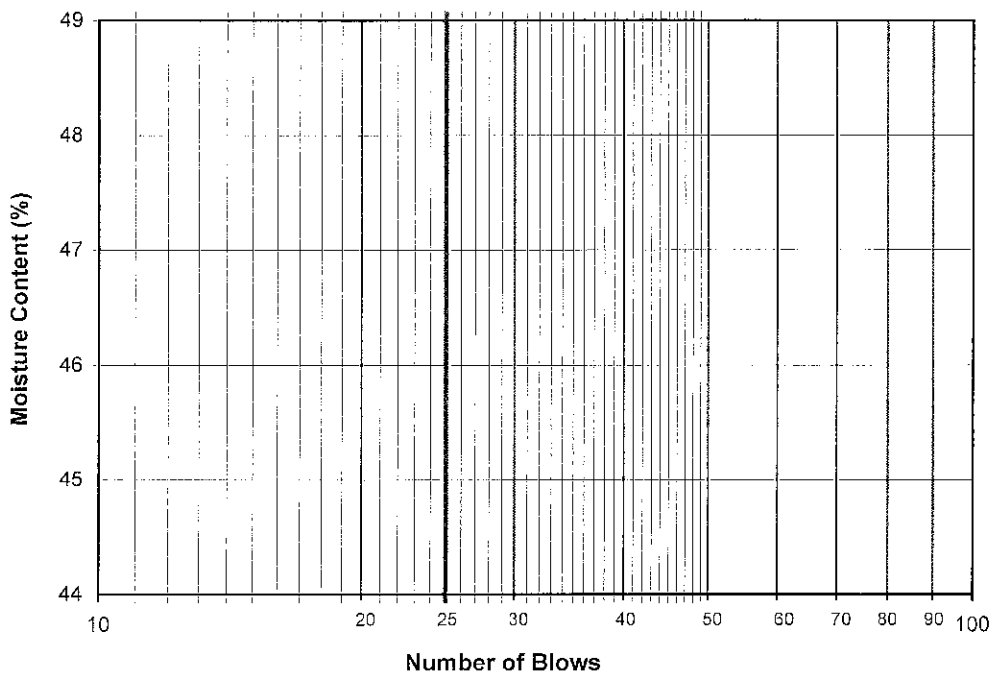



# MODIFIED PROCTOR COMPACTION TEST

ASTM D 1557

Project Name: San Pedro - Self Storage Tested By: RA Date: 09/30/04  
 Project No.: 041104-01 Input By: LF Date: 10/04/04  
 Boring No.: LGC-1 Depth (ft.): 7-9  
 Sample No.: B-1  
 Soil Identification: Olive silty sand (SM) /

Preparation Method:  Moist  Dry  Mechanical Ram  Manual Ram  
**Mold Volume (ft<sup>3</sup>)** 0.03330 *Ram Weight = 10 lb.; Drop = 18 in.*

TEST NO.	1	2	3	4	5	6
Wt. Compacted Soil + Mold (g)	3662.6	3732.5	3778.6	3748.8		
Weight of Mold (g)	1998.0	1998.0	1998.0	1998.0		
Net Weight of Soil (g)	1664.6	1734.5	1780.6	1750.8		
Wet Weight of Soil + Cont. (g)	535.80	530.30	556.10	558.20		
Dry Weight of Soil + Cont. (g)	504.00	489.40	502.90	493.80		
Weight of Container (g)	75.30	77.30	76.70	79.20		
Moisture Content (%)	7.42	9.92	12.48	15.53		
Wet Density (pcf)	110.2	114.8	117.9	115.9		
Dry Density (pcf)	102.6	104.5	104.8	100.3		

**Maximum Dry Density (pcf)** 105.0 **Optimum Moisture Content (%)** 11.5

## PROCEDURE USED

**Procedure A**  
 Soil Passing No. 4 (4.75 mm) Sieve  
 Mold : 4 in. (101.6 mm) diameter  
 Layers : 5 (Five)  
 Blows per layer : 25 (twenty-five)  
 May be used if + #4 is 20% or less

**Procedure B**  
 Soil Passing 3/8 in. (9.5 mm) Sieve  
 Mold : 4 in. (101.6 mm) diameter  
 Layers : 5 (Five)  
 Blows per layer : 25 (twenty-five)  
 Use if + #4 is >20% and +3/8 in. is 20% or less

**Procedure C**  
 Soil Passing 3/4 in. (19.0 mm) Sieve  
 Mold : 6 in. (152.4 mm) diameter  
 Layers : 5 (Five)  
 Blows per layer : 56 (fifty-six)  
 Use if +3/8 in. is >20% and +3/4 in. is <30%

## Particle-Size Distribution:

GR:SA:FI

**Atterberg Limits:**  
  
 LL, PL, PI

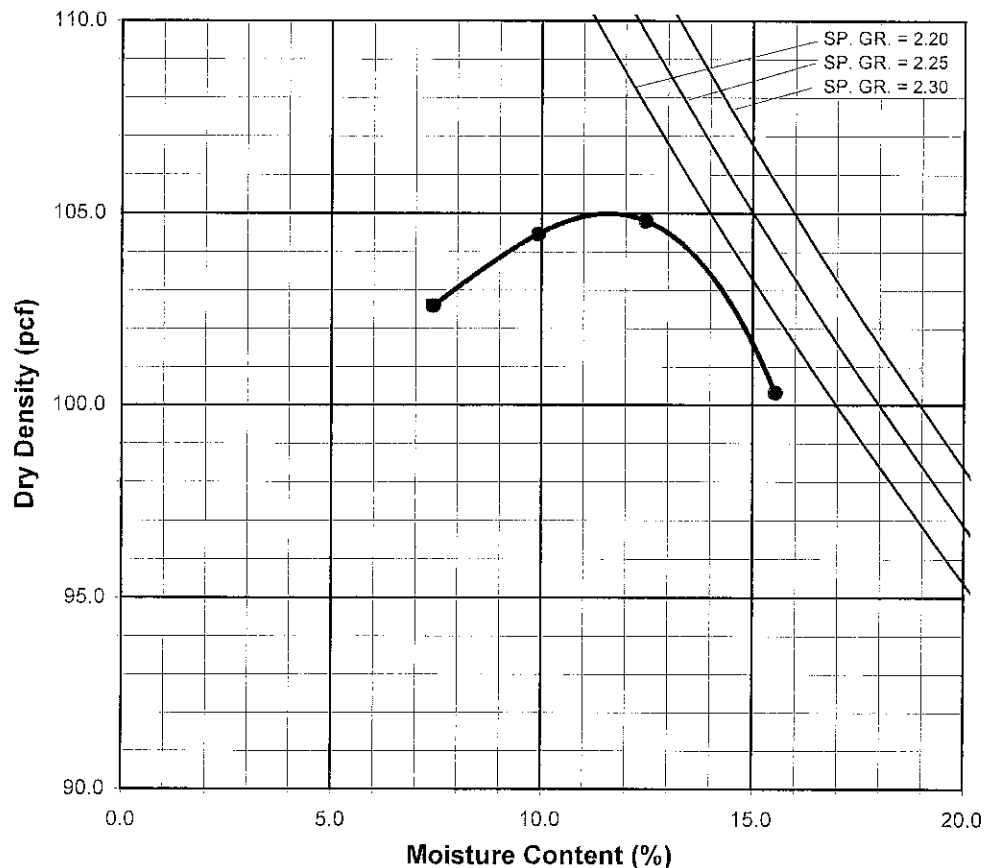



## EXPANSION INDEX of SOILS

ASTM D 4829

Project Name:	San Pedro - Self Storage	Tested By:	RA	Date:	09/28/04
Project No. :	041104-01	Checked By:	LF	Date:	10/01/04
Boring No.:	LGC-2	Depth (ft.)	11-13		
Sample No. :	B-1				
Soil Identification:	Olive yellow silty sand (SM)				

Dry Wt. of Soil + Cont.	(g)	1000.00
Wt. of Container No.	(g)	0.00
Dry Wt. of Soil	(g)	1000.00
Weight Soil Retained on #4 Sieve		0.00
Percent Passing # 4		100.00

MOLDED SPECIMEN	Before Test	After Test
Specimen Diameter (in.)	4.01	4.01
Specimen Height (in.)	1.0000	1.0167
Wt. Comp. Soil + Mold (g)	544.60	417.70
Wt. of Mold (g)	163.80	0.00
Specific Gravity (Assumed)	2.70	2.70
Container No.	0	0
Wet Wt. of Soil + Cont. (g)	782.00	581.50
Dry Wt. of Soil + Cont. (g)	705.80	507.50
Wt. of Container (g)	0.00	163.80
Moisture Content (%)	10.80	21.53
Wet Density (pcf)	114.9	123.9
Dry Density (pcf)	103.7	102.0
Void Ratio	0.626	0.653
Total Porosity	0.385	0.395
Pore Volume (cc)	79.7	83.2
Degree of Saturation (%) [ S <sub>meas</sub> ]	<b>46.6</b>	89.0

**SPECIMEN INUNDATION** in distilled water for the period of 24 h or expansion rate < 0.0002 in./h

Date	Time	Pressure (psi)	Elapsed Time (min.)	Dial Readings (in.)
09/28/04	15:20	1.0	0	0.5743
09/28/04	15:30	1.0	10	0.5742
Add Distilled Water to the Specimen				
09/28/04	15:31	1.0	1	0.5780
09/29/04	8:30	1.0	1020	0.5910
09/29/04	10:00	1.0	1110	0.5910

Expansion Index (EI <sub>meas</sub> ) = ((Final Rdg - Initial Rdg) / Initial Thick.) x 1000	16.8
Expansion Index (EI) <sub>50</sub> = EI <sub>meas</sub> - (50 - S <sub>meas</sub> ) x ((65 + EI <sub>meas</sub> ) / (220 - S <sub>meas</sub> ))	<b>15</b>

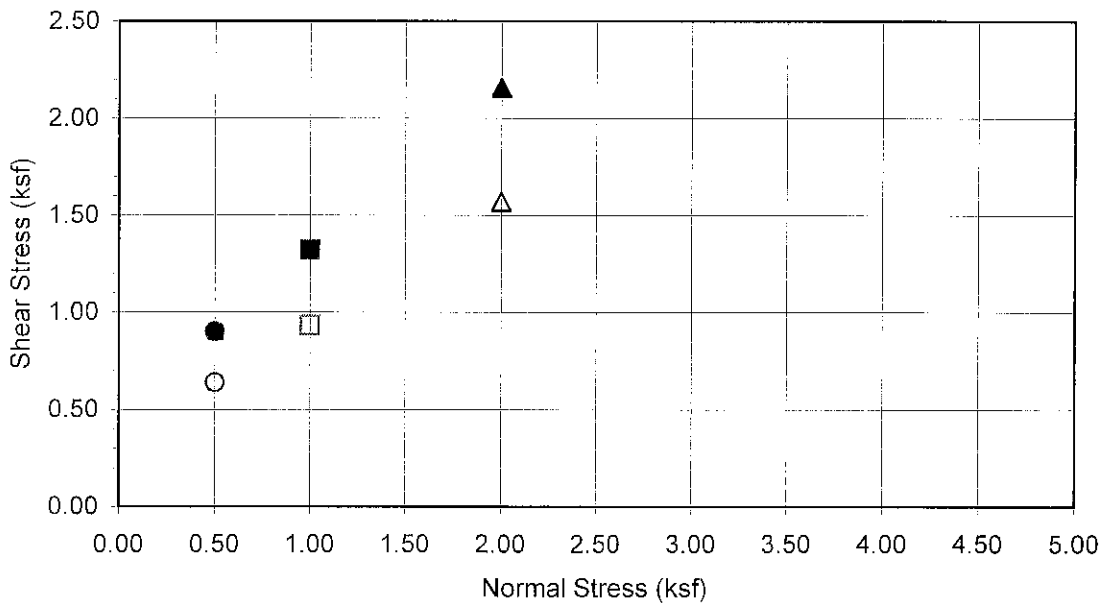
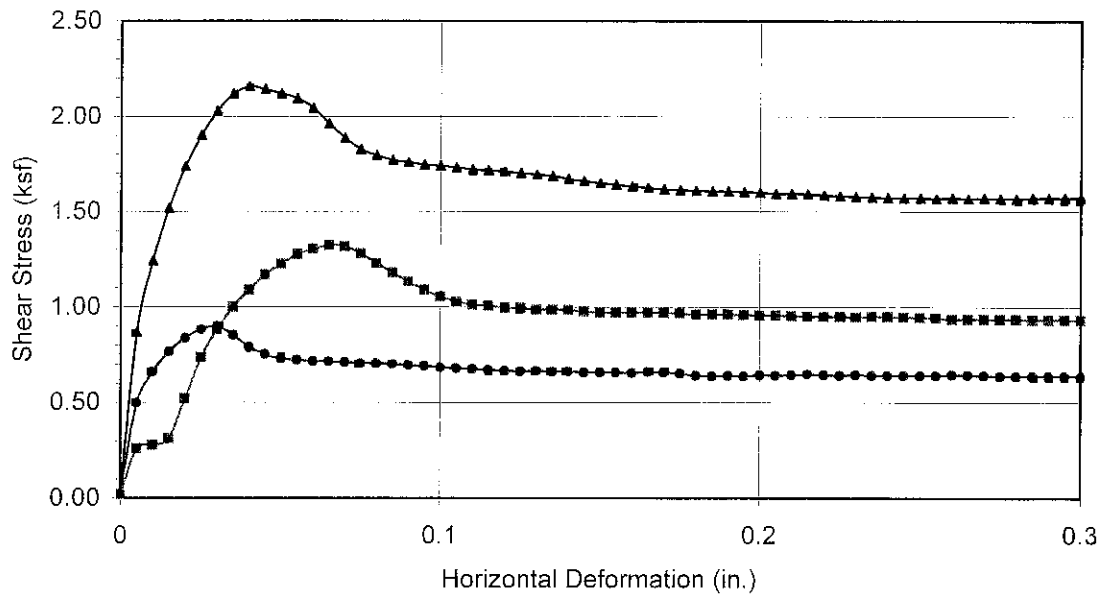

<b>Boring No.</b>	<b>LGC-1</b>
<b>Sample No.</b>	<b>R-2</b>
<b>Depth (ft)</b>	<b>10</b>
<u>Sample Type:</u>	
Drive	
<u>Soil Identification:</u>	
Olive yellow silty sand (SM)	

Normal Stress (kip/ft <sup>2</sup> )	0.500	1.000	2.000
Peak Shear Stress (kip/ft <sup>2</sup> )	● 0.901	■ 1.322	▲ 2.158
Shear Stress @ End of Test (ksf)	○ 0.639	□ 0.932	△ 1.571
Deformation Rate (in./min.)	0.0033	0.0033	0.0033
Initial Sample Height (in.)	1.000	1.000	1.000
Diameter (in.)	2.415	2.415	2.415
Initial Moisture Content (%)	8.39	8.39	8.39
Dry Density (pcf)	100.3	101.5	109.7
Saturation (%)	33.3	34.2	42.2
Soil Height Before Shearing (in.)	0.9974	0.9945	0.9870
Final Moisture Content (%)	26.0	25.4	22.2



**DIRECT SHEAR TEST RESULTS**  
Consolidated Drained - ASTM D 3080

Project No.: 041104-01  
San Pedro - Self Storage

09-04



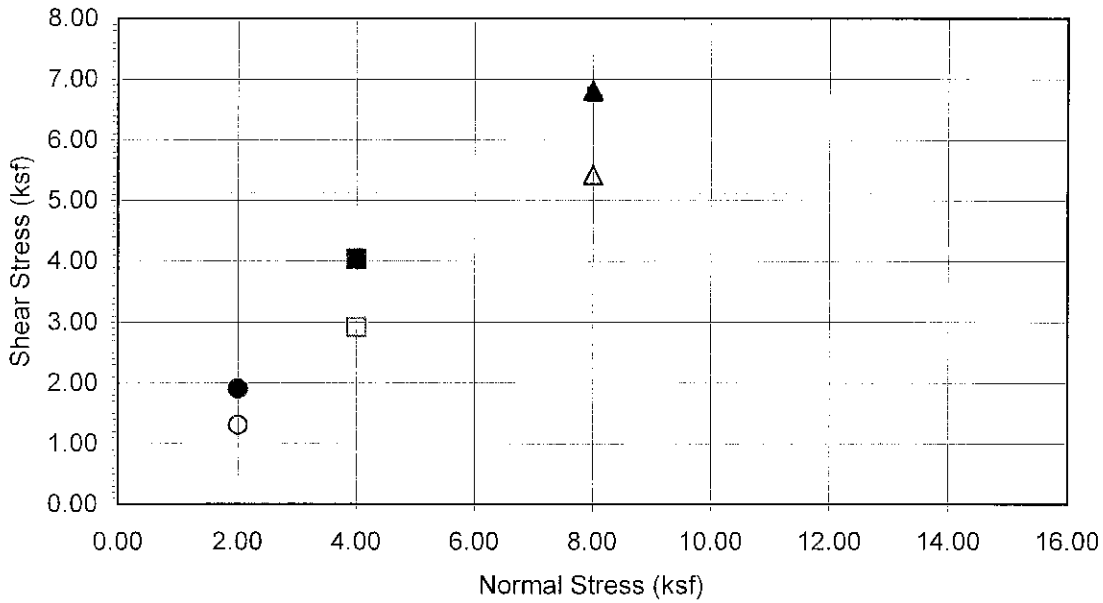
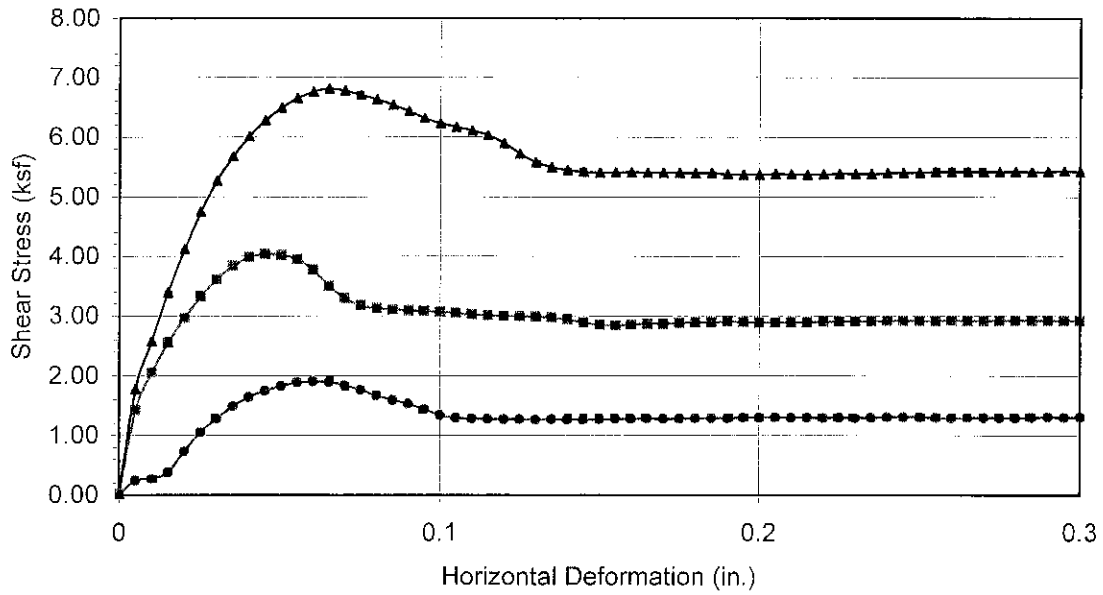

<b>Boring No.</b>	<b>LGC-2</b>
<b>Sample No.</b>	<b>R-5</b>
<b>Depth (ft)</b>	<b>60</b>
<u>Sample Type:</u>	
Drive	
<u>Soil Identification:</u>	
Olive silty sand (SM)	

Normal Stress (kip/ft <sup>2</sup> )	2.000	4.000	8.000
Peak Shear Stress (kip/ft <sup>2</sup> )	● 1.905	■ 4.038	▲ 6.812
Shear Stress @ End of Test (ksf)	○ 1.309	□ 2.918	△ 5.422
Deformation Rate (in./min.)	0.0033	0.0033	0.0033
Initial Sample Height (in.)	1.000	1.000	1.000
Diameter (in.)	2.415	2.415	2.415
Initial Moisture Content (%)	20.88	20.88	20.88
Dry Density (pcf)	105.1	105.4	105.7
Saturation (%)	93.5	94.0	94.8
Soil Height Before Shearing (in.)	0.9880	0.9742	0.9682
Final Moisture Content (%)	24.0	23.7	23.1



**DIRECT SHEAR TEST RESULTS**  
Consolidated Drained - ASTM D 3080

Project No.: 041104-01  
San Pedro - Self Storage

09-04

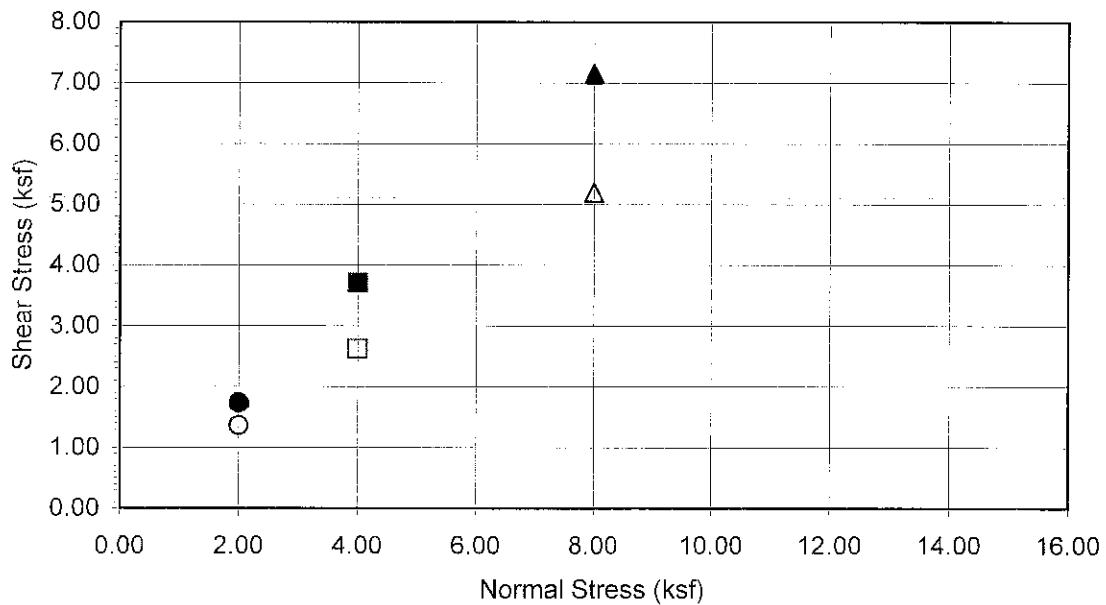
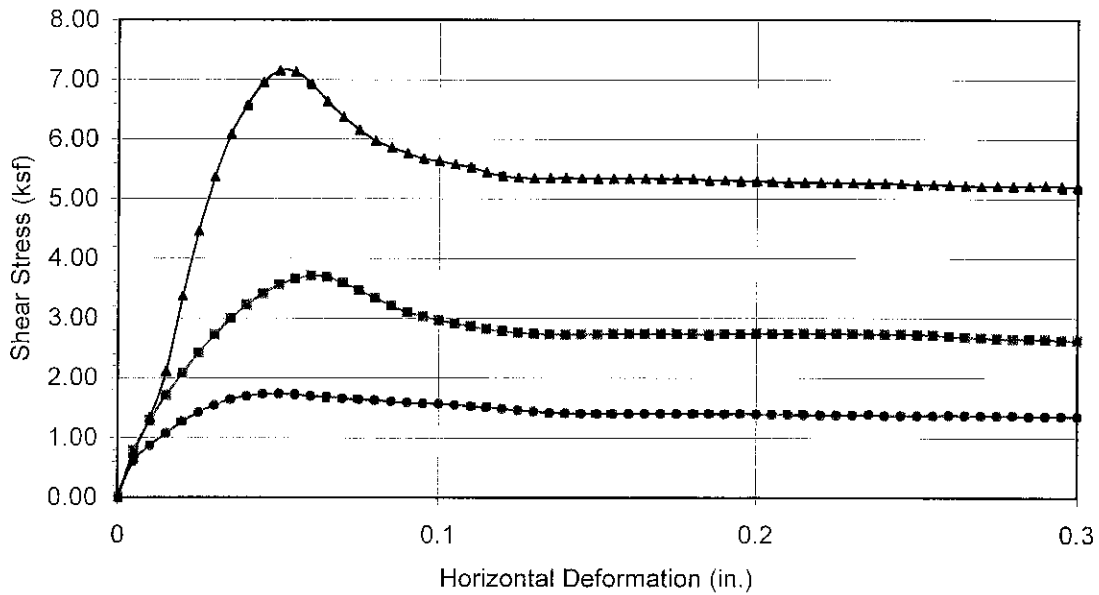

<b>Boring No.</b>	<b>LGC-3</b>
<b>Sample No.</b>	<b>R-4</b>
<b>Depth (ft)</b>	<b>35</b>
<u>Sample Type:</u>	
Drive	
<u>Soil Identification:</u>	
Olive silty sand (SM)	

Normal Stress (kip/ft <sup>2</sup> )	2.000	4.000	8.000
Peak Shear Stress (kip/ft <sup>2</sup> )	● 1.733	■ 3.707	▲ 7.152
Shear Stress @ End of Test (ksf)	○ 1.359	□ 2.622	△ 5.200
Deformation Rate (in./min.)	0.0033	0.0033	0.0033
Initial Sample Height (in.)	1.000	1.000	1.000
Diameter (in.)	2.415	2.415	2.415
Initial Moisture Content (%)	10.15	10.15	10.15
Dry Density (pcf)	98.0	98.5	102.4
Saturation (%)	38.1	38.5	42.4
Soil Height Before Shearing (in.)	0.9882	0.9756	0.9736
Final Moisture Content (%)	24.2	22.6	22.2



**DIRECT SHEAR TEST RESULTS**  
Consolidated Drained - ASTM D 3080

Project No.: 041104-01  
San Pedro - Self Storage

09-04

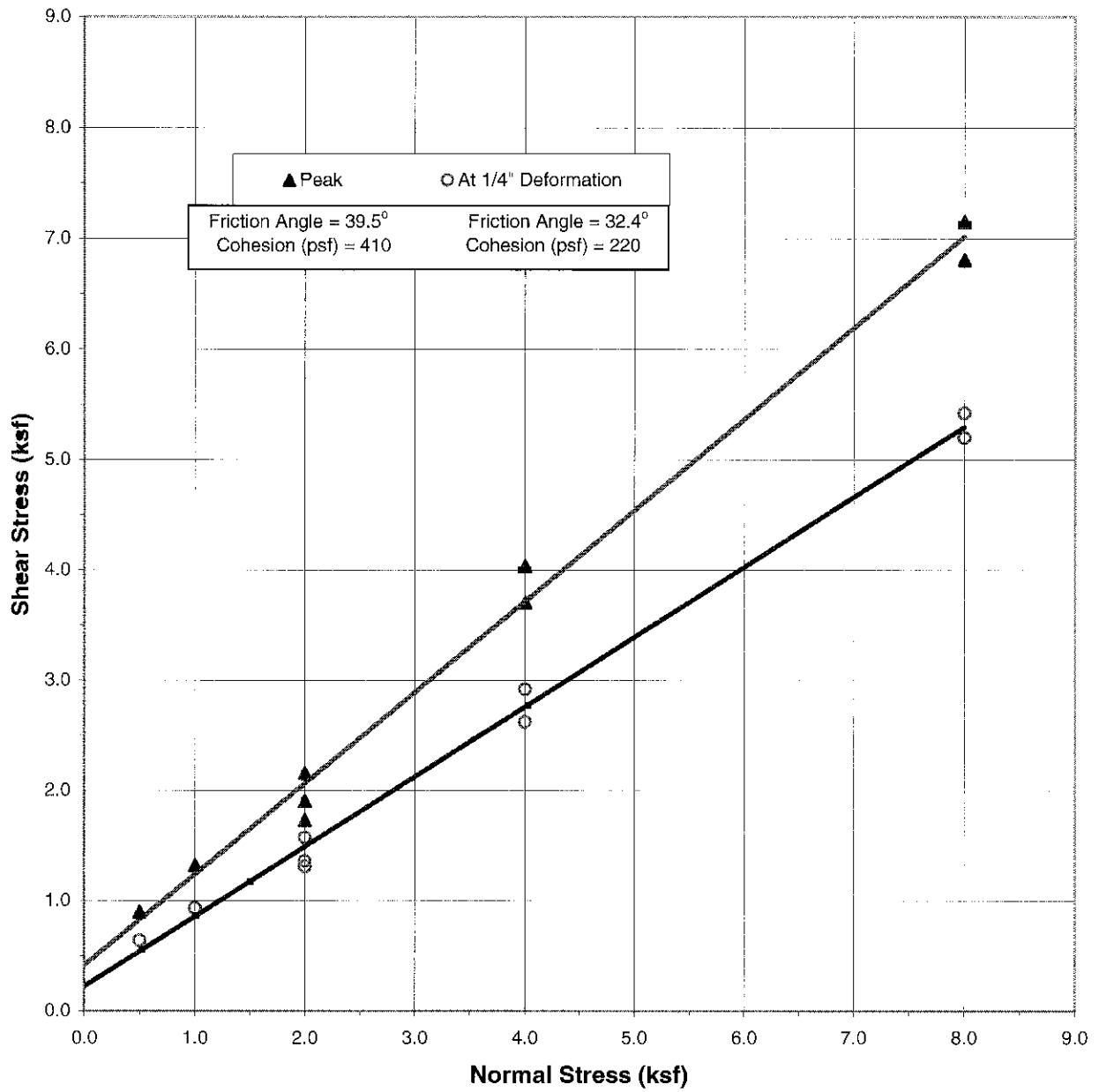

LGC - 1 @ 10 FT  
 LGC - 2 @ 60 FT  
 LGC - 3 @ 35 FT

**LGC**

**COMPOSITE DIRECT SHEAR PLOT**

Project Number: 041104-01

Date: Dec-04

San Pedro - Self Storage

No Time Readings

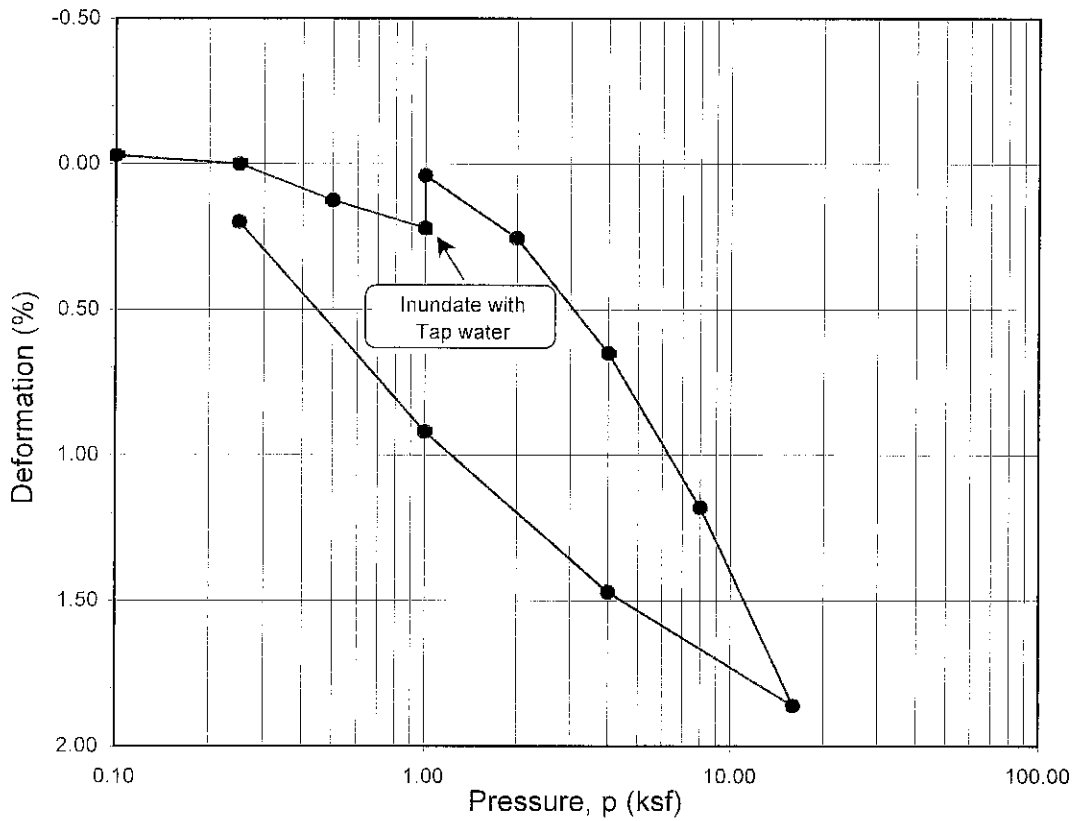
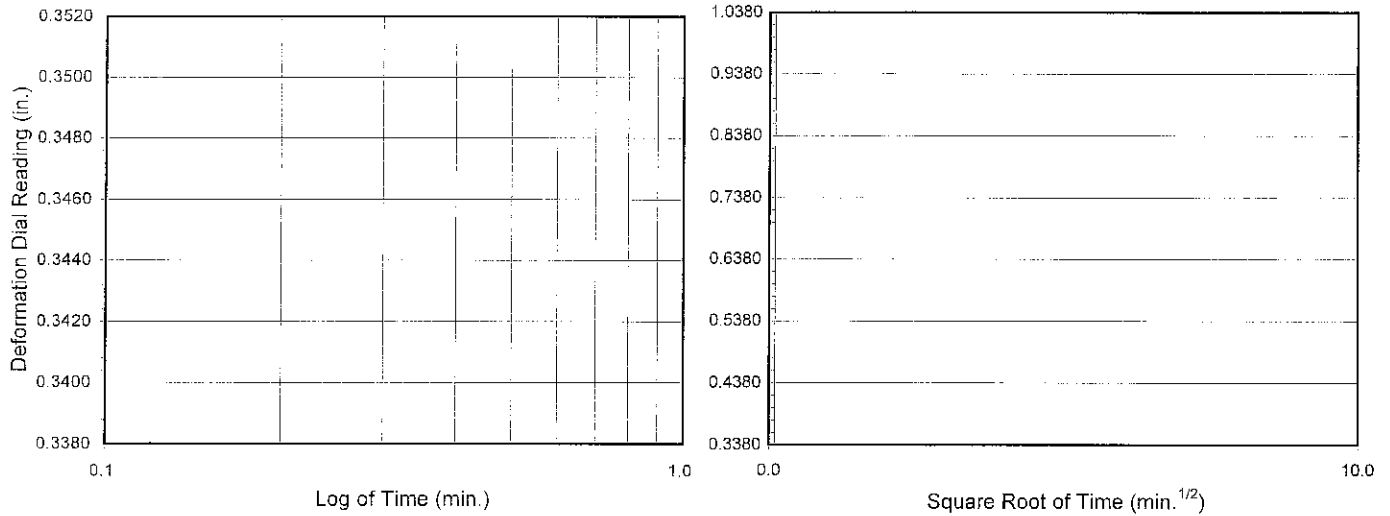

Boring No.	Sample No.	Depth (ft.)	Moisture Content (%)		Dry Density (pcf)		Void Ratio		Degree of Saturation (%)	
			Initial	Final	Initial	Final	Initial	Final	Initial	Final
<b>LGC-2</b>	<b>R-2</b>	<b>10</b>	<b>8.9</b>	<b>19.6</b>	<b>105.5</b>	<b>106.8</b>	<b>0.598</b>	<b>0.595</b>	<b>40</b>	<b>91</b>

Soil Identification: Olive brown sandy silt s(ML)



Leighton

**ONE-DIMENSIONAL CONSOLIDATION  
PROPERTIES of SOILS  
(ASTM D 2435)**

Project No.: 041104-01

San Pedro - Self Storage

No Time Readings

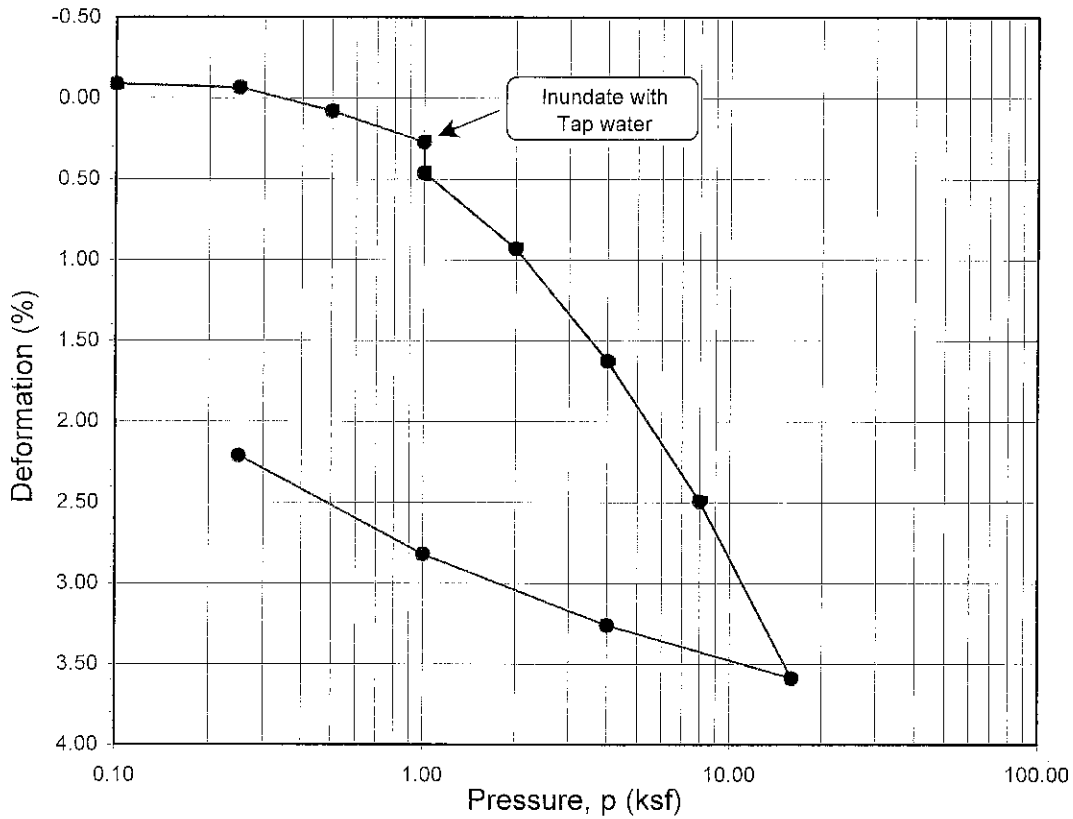
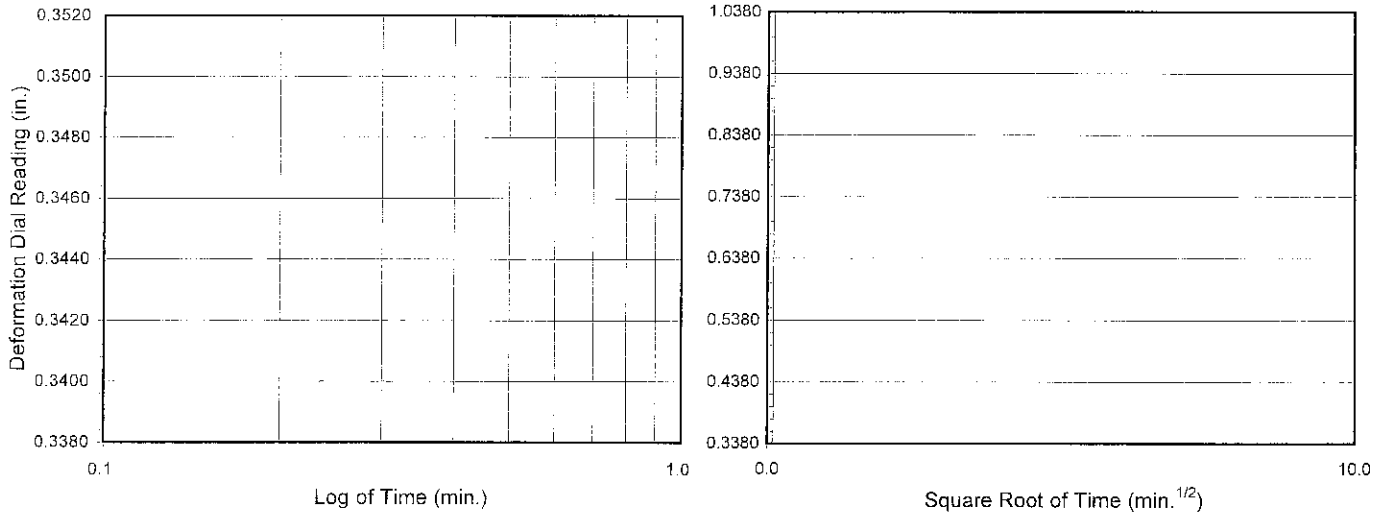

Boring No.	Sample No.	Depth (ft.)	Moisture Content (%)		Dry Density (pcf)		Void Ratio		Degree of Saturation (%)	
			Initial	Final	Initial	Final	Initial	Final	Initial	Final
<b>LGC-3</b>	<b>R-1</b>	<b>5</b>	<b>4.8</b>	<b>25.0</b>	<b>95.2</b>	<b>97.5</b>	<b>0.770</b>	<b>0.731</b>	<b>17</b>	<b>92</b>

Soil Identification: Light brown silty sand (SM)



Leighton

**ONE-DIMENSIONAL CONSOLIDATION  
PROPERTIES OF SOILS  
(ASTM D 2435)**

Project No.: 041104-01

San Pedro - Self Storage



## SOIL RESISTIVITY TEST

**DOT CA TEST 532 / 643**

Project Name: San Pedro - Self Storage  
 Project No. : 041104-01  
 Boring No.: LGC-2  
 Sample No. : B-1  
 Soil Identification: SM

Tested By : VJ Date: 09/28/04  
 Data Input By: LF Date: 10/01/04  
 Depth (ft.) : 11-13

Specimen No.	Water Added (ml) (Wa)	Adjusted Moisture Content (MC)	Resistance Reading (ohm)	Soil Resistivity (ohm-cm)
1	200	26.38	850	5734
2	300	34.81	760	5127
3	400	43.23	770	5194
4				
5				

Moisture Content (%) (Mci)	9.53
Wet Wt. of Soil + Cont. (g)	186.38
Dry Wt. of Soil + Cont. (g)	175.33
Wt. of Container (g)	59.38
Container No.	
Initial Soil Wt. (g) (Wt)	1300.00
Box Constant	6.746
$MC = (((1+Mci/100) \times (Wa/Wt+1)) - 1) \times 100$	

Min. Resistivity (ohm-cm)	Moisture Content (%)	Sulfate Content (ppm)	Chloride Content (ppm)	Soil pH	
				pH	Temp. (°C)
DOT CA Test 532 / 643		DOT CA Test 417 Part II	DOT CA Test 422	DOT CA Test 532 / 643	
<b>5100</b>	<b>37.0</b>	<b>77</b>	<b>33</b>	<b>8.17</b>	<b>21.0</b>

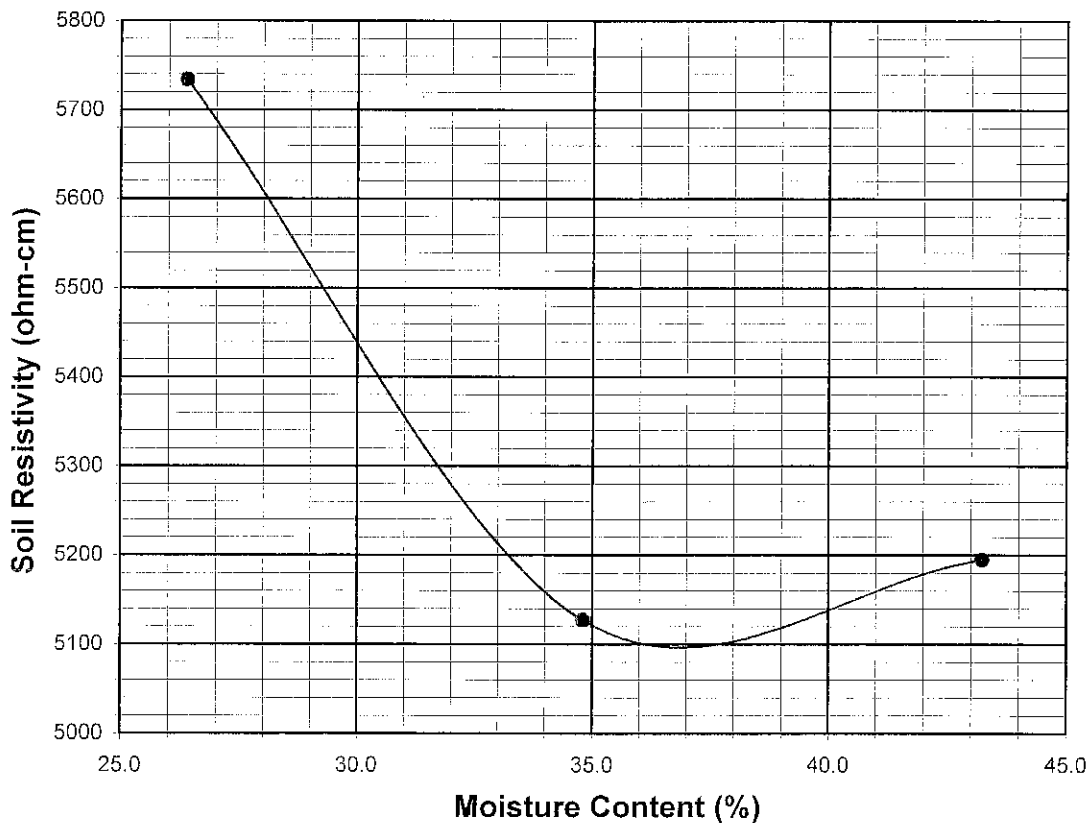

*From Lawson, 2007a*

*Appendix C*  
*Laboratory Test Results*



## *APPENDIX C*

### *Laboratory Testing Procedures and Test Results*

The laboratory testing program was directed towards providing quantitative data relating to the relevant engineering properties of the soils. Samples considered representative of site conditions were tested in general accordance with American Society for Testing and Materials (ASTM) procedure and/or California Test Methods (CTM), where applicable. The following summary is a brief outline of the test.

Moisture and Density Determination Tests: Moisture content (ASTM D2216) and dry density determinations (ASTM D2937) were performed on relatively undisturbed samples obtained from the test borings and/or trenches. The results of these tests are presented in the boring logs.

Direct Shear: Direct shear tests were performed on selected driven and/or remolded samples, which were soaked for a minimum of 24 hours. The samples were tested under various normal loads, a motor-driven, strain-controlled, direct-shear testing apparatus. The plots are provided in this appendix.

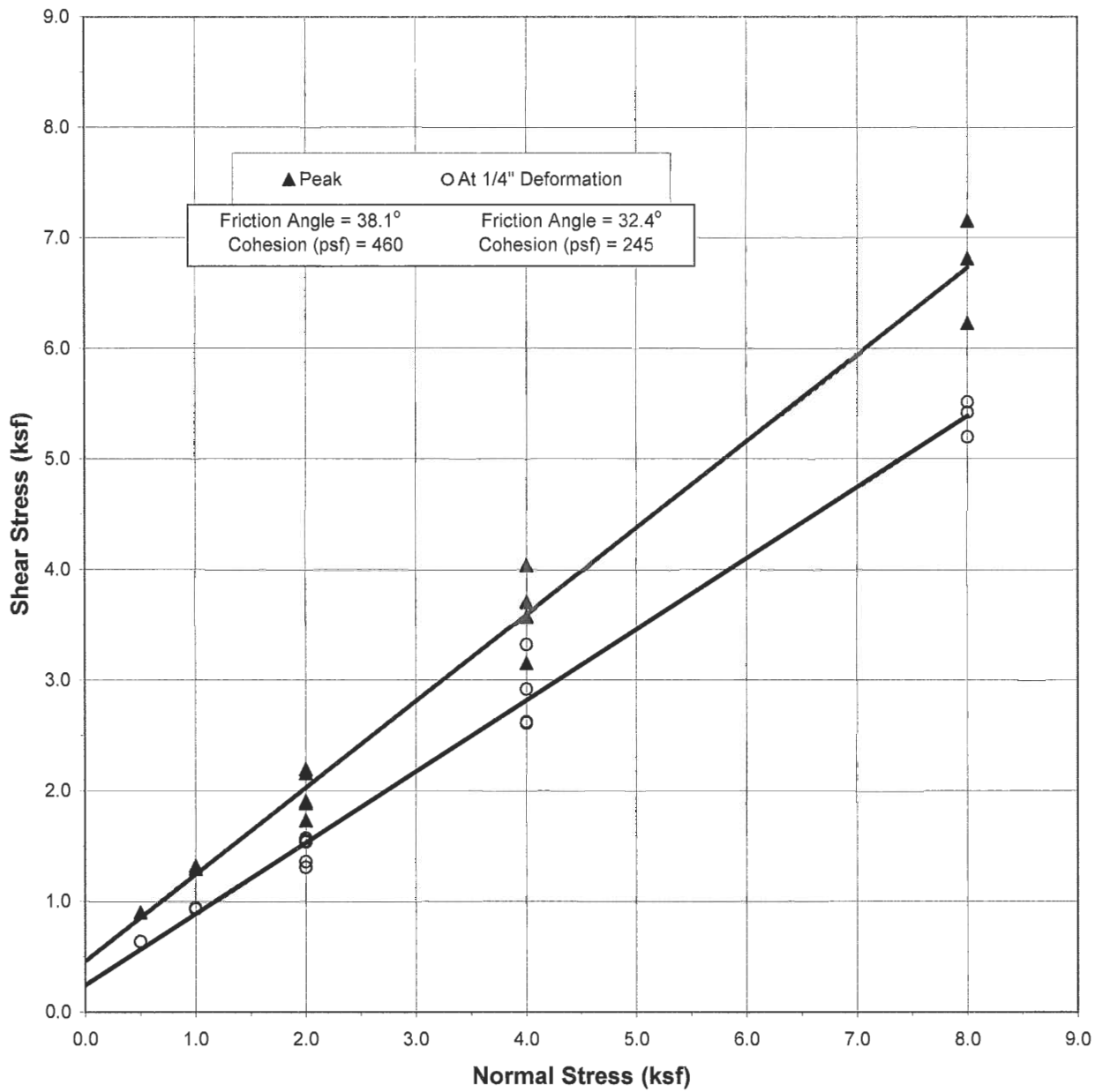

LGC - 1 @ 10 FT\*  
 LGC - 2 @ 60 FT\*  
 LGC - 3 @ 35 FT\*  
 LGC - 4 @ 35 FT  
 LGC - 5 @ 15 FT

\* From LGC, 2005)

**LGC**

**COMPOSITE DIRECT SHEAR  
PLOT**

Project Number: 041104-01  
 Date: Jul-07

**Self Storage San Pedro**

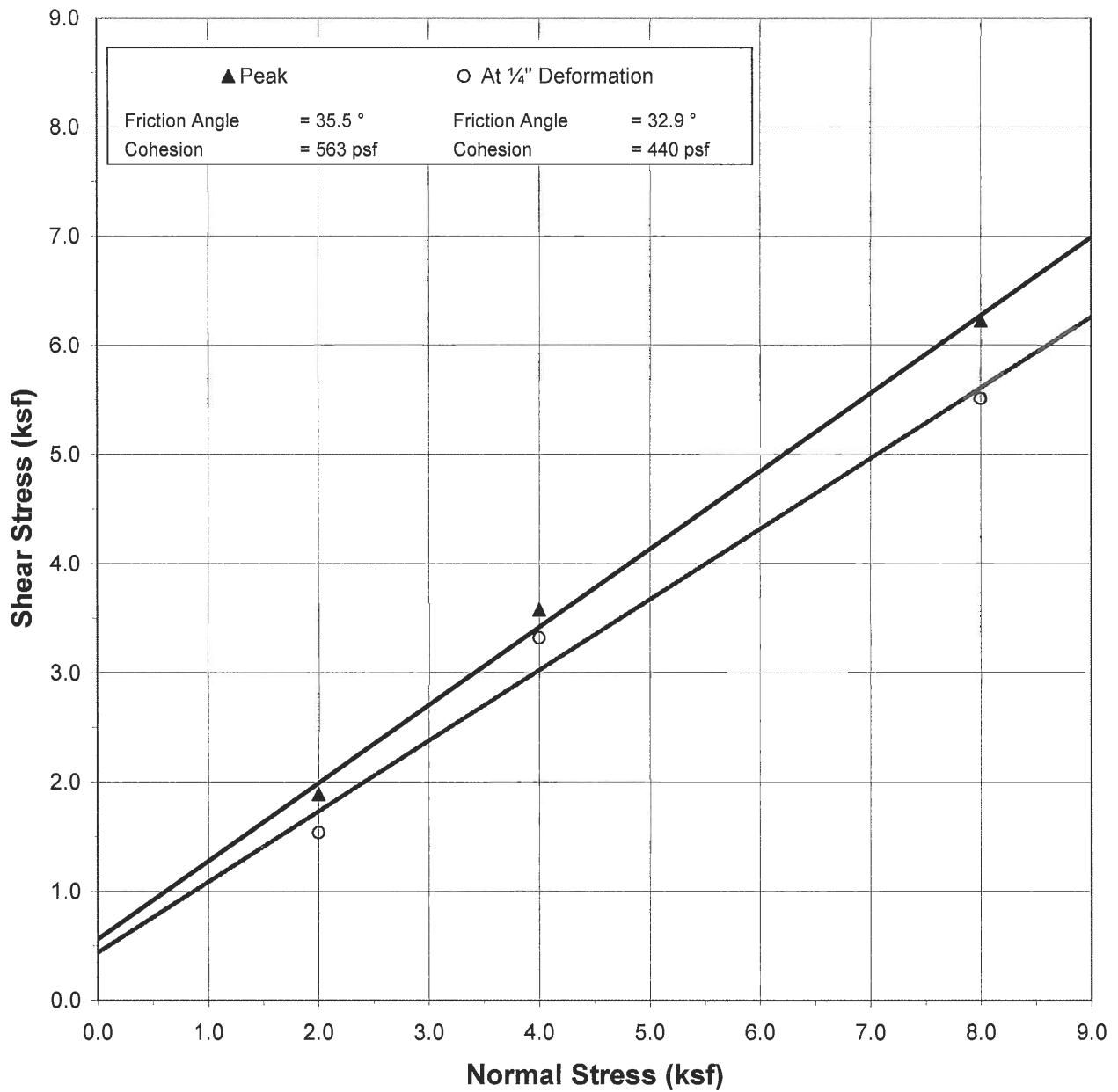

Location:	Sample No.:	Depth (ft)	Sample Type	Shear Rate (inch/min)	Dry Density (pcf)	Initial Moisture Content (%)	Final Moisture Content (%)
LGC-4	R-4	35	Driven	0.001	102.4	8.7	25.8

Sample Description: Silty Sand

**LGC**

**DIRECT SHEAR PLOT**

Project Number: 041104-01  
Date: Jul-07

**Self Storage San Pedro**

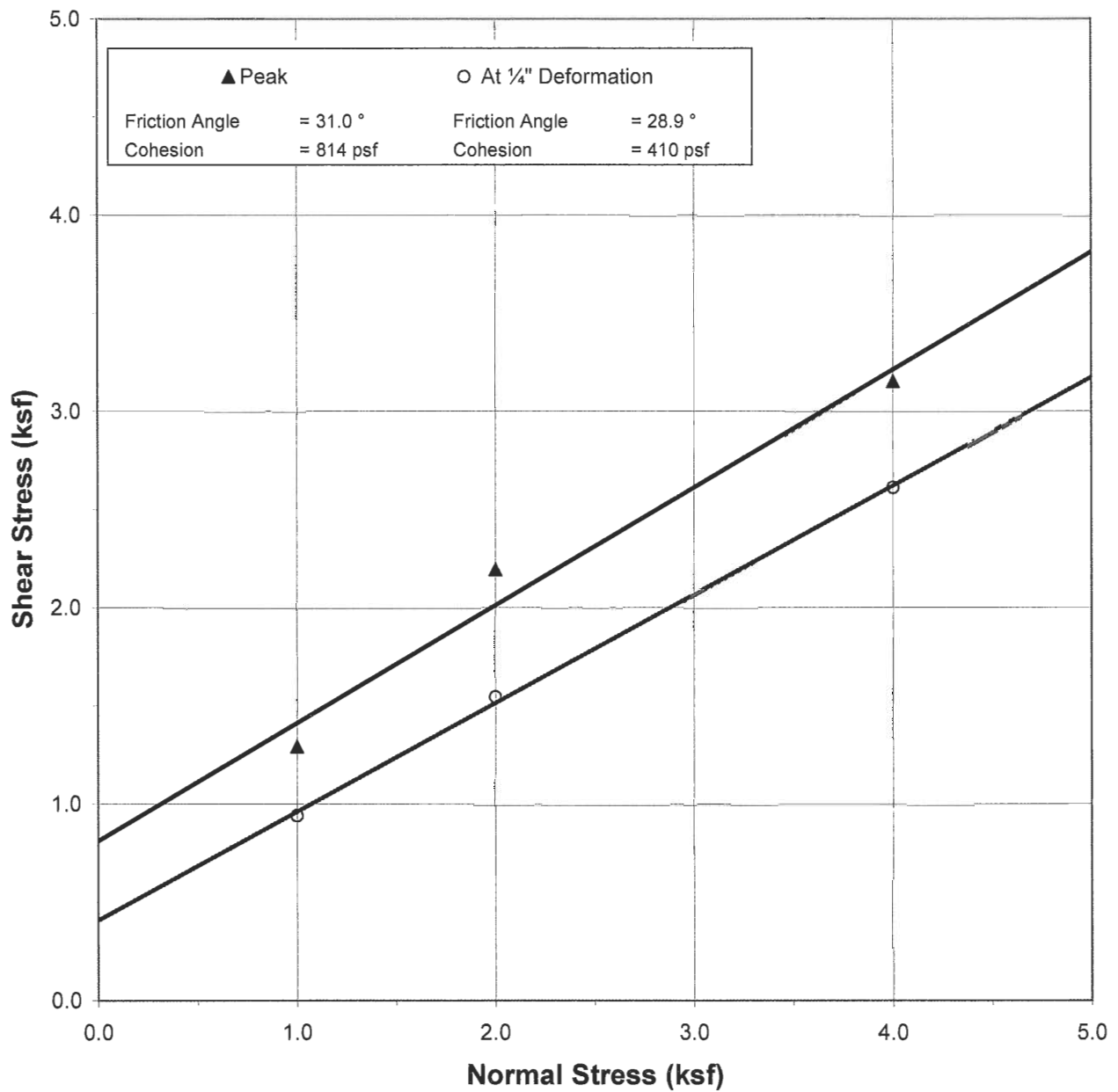

Location:	Sample No.:	Depth (ft)	Sample Type	Shear Rate (inch/min)	Dry Density (pcf)	Initial Moisture Content (%)	Final Moisture Content (%)
LGC-5	R-2	15	Driven	0.001	95.1	5.7	29.6

Sample Description: Gray/Tan Fine Silty Sand

**LGC**

**DIRECT SHEAR PLOT**

Project Number: 041104-01  
 Date: Jul-07

**Self Storage San Pedro**

*Appendix D*  
*Slope Stability and Engineering Analyses*

**Summary of Slope Stability Analysis**

<b>Cross-Section</b>	<b>File Name</b>	<b>Factor of Safety</b>	<b>Description</b>
A-A'	axl	1.53	Static
	axle	1.63	Seismic
B-B'	bxl	1.95	Static
	bxle	1.88	Seismic
C-C'	cxl2	1.90	Entire Slope w/Keyway – Static
	cxl2e	1.46	Seismic
	cxl	1.68	Upper Slope w/Keyway – Static
	cxle	1.37	Seismic
D-D'	dxl	1.74	Static (MSE “C” Global Zone – 0.7 x Wall Height)
	dxle	1.75	Seismic
E-E'	exl2	1.98	Entire Slope w/Keyway – Static
	exl2e	1.52	Seismic
	exl	1.75	Mid Slope w/Keyway – Static
	exle	1.40	Seismic
F-F'	fxsx	1.58	Static (MSE “D” Global Zone – 0.7 x Wall Height)
	fxsxe	1.59	Seismic
	fxsx2	4.18	Along Bedding – Static
	fxsx2e	1.97	Seismic
G-G'	gx2s	1.63	Static (MSE “E” Global Zone – 0.7 x Wall Height)
	gx2se	1.38	Seismic
	gx2	5.05	Along Bedding – Static
	gx2e	2.24	Seismic
H-H'	hxsx	1.52	Static (MSE “E” Global Zone – 0.7 x Wall Height)
	hxsxe	1.49	Seismic
I-I'	ixs	1.70	Static (MSE “E” Global Zone – 0.7 x Wall Height)
	ixse	1.64	Seismic

# 12091-01 / John S. Gibson / Sec. A-A' / Static

z:\2012\12091-01 howard industrial partners - john s gibson blvd\engineering\slope stability\sections\a-a'\axl.pl2 Run By: SHH 3/14/2019 12:21PM

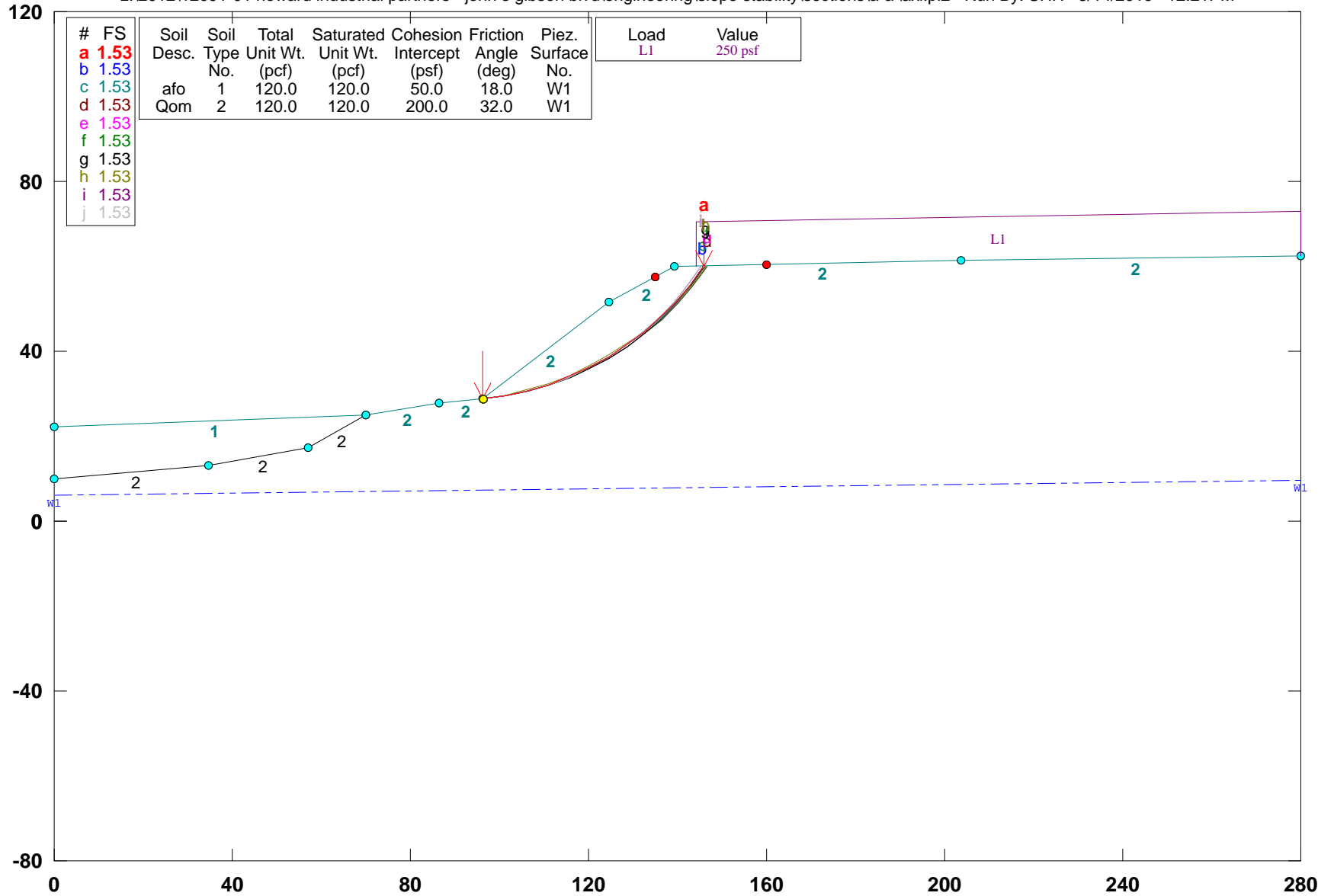

GSTABL7 v.2 FSmin=1.53  
 Safety Factors Are Calculated By The Modified Bishop Method

\*\*\* GSTABL7 \*\*\*

\*\* GSTABL7 by Dr. Garry H. Gregory, Ph.D., P.E., D.GE \*\*

\*\* Original Version 1.0, January 1996; Current Ver. 2.005.3, Feb. 2013 \*\*  
 (All Rights Reserved-Unauthorized Use Prohibited)

\*\*\*\*\*

SLOPE STABILITY ANALYSIS SYSTEM

Modified Bishop, Simplified Janbu, or GLE Method of Slices.  
 (Includes Spencer & Morgenstern-Price Type Analysis)  
 Including Pier/Pile, Reinforcement, Soil Nail, Tieback,  
 Nonlinear Undrained Shear Strength, Curved Phi Envelope,  
 Anisotropic Soil, Fiber-Reinforced Soil, Boundary Loads, Water  
 Surfaces, Pseudo-Static & Newmark Earthquake, and Applied Forces.

\*\*\*\*\*

Analysis Run Date: 3/14/2019

Time of Run: 12:21PM

Run By: SHH

Input Data Filename: z:\2012\12091-01 Howard Industrial Partners - John S Gibson

Blvd\Engineering\Slope Stability\Sections\A-A'\axl.in

Output Filename: z:\2012\12091-01 Howard Industrial Partners - John S Gibson

Blvd\Engineering\Slope Stability\Sections\A-A'\axl.OUT

Unit System: English

Plotted Output Filename: z:\2012\12091-01 Howard Industrial Partners - John S Gibson

Blvd\Engineering\Slope Stability\Sections\A-A'\axl.PLT

PROBLEM DESCRIPTION: 12091-01 / John S. Gibson / Sec. A-A' /  
 Static

BOUNDARY COORDINATES

7 Top Boundaries

10 Total Boundaries

Boundary No.	X-Left (ft)	Y-Left (ft)	X-Right (ft)	Y-Right (ft)	Soil Type Below Bnd
1	0.00	22.30	69.90	24.90	1
2	69.90	24.90	86.50	27.90	2
3	86.50	27.90	96.40	28.70	2
4	96.40	28.70	124.60	51.50	2
5	124.60	51.50	139.20	59.90	2
6	139.20	59.90	203.70	61.40	2
7	203.70	61.40	280.00	62.60	2
8	0.00	10.00	34.80	13.20	2
9	34.80	13.20	57.20	17.20	2
10	57.20	17.20	69.90	24.90	2

Default Y-Origin = 0.00(ft)

Default X-Plus Value = 0.00(ft)

Default Y-Plus Value = 0.00(ft)

ISOTROPIC SOIL PARAMETERS

2 Type(s) of Soil

Soil Type	Total Unit Wt. (pcf)	Saturated Unit Wt. (pcf)	Cohesion (psf)	Friction Angle (deg)	Pore Pressure Param. (psf)	Pressure Constant	Piez. Surface
1	120.0	120.0	50.0	18.0	0.00	0.0	1
2	120.0	120.0	200.0	32.0	0.00	0.0	1

1 PIEZOMETRIC SURFACE(S) SPECIFIED

Unit Weight of Water = 62.40 (pcf)

Piezometric Surface No. 1 Specified by 2 Coordinate Points

Pore Pressure Inclination Factor = 0.50

Point No.	X-Water (ft)	Y-Water (ft)
1	0.00	6.10
2	280.00	9.70

BOUNDARY LOAD(S)

1 Load(s) Specified

Load No.	X-Left (ft)	X-Right (ft)	Intensity (psf)	Deflection (deg)
1	144.20	280.00	250.0	0.0

NOTE - Intensity Is Specified As A Uniformly Distributed Force Acting On A Horizontally Projected Surface.

A Critical Failure Surface Searching Method, Using A Random Technique For Generating Circular Surfaces, Has Been Specified.

5000 Trial Surfaces Have Been Generated.

200 Surface(s) Initiate(s) From Each Of 25 Points Equally Spaced Along The Ground Surface Between X = 96.40(ft)

and X = 96.40(ft)  
 Each Surface Terminates Between X = 135.00(ft)  
 and X = 160.00(ft)  
 Unless Further Limitations Were Imposed, The Minimum Elevation At Which A Surface Extends Is Y = 0.00(ft)  
 5.00(ft) Line Segments Define Each Trial Failure Surface.  
 Following Are Displayed The Ten Most Critical Of The Trial Failure Surfaces Evaluated. They Are Ordered - Most Critical First.

\* \* Safety Factors Are Calculated By The Modified Bishop Method \* \*

Total Number of Trial Surfaces Attempted = 5000  
 Number of Trial Surfaces With Valid FS = 5000  
 Statistical Data On All Valid FS Values:  
 FS Max = 3.155 FS Min = 1.527 FS Ave = 1.944  
 Standard Deviation = 0.291 Coefficient of Variation = 14.99 %  
 Failure Surface Specified By 14 Coordinate Points

Point No.	X-Surf (ft)	Y-Surf (ft)
1	96.400	28.700
2	101.337	29.491
3	106.203	30.641
4	110.971	32.145
5	115.617	33.995
6	120.114	36.179
7	124.439	38.698
8	128.569	41.507
9	132.481	44.620
10	136.155	48.013
11	139.569	51.665
12	142.707	55.557
13	145.552	59.670
14	145.777	60.053

Circle Center At X = 88.119 ; Y = 96.301 ; and Radius = 68.106

Factor of Safety = 1.527

Slice No.	Width (ft)	Weight (lbs)	Water Force (lbs)	Tie Force (lbs)	Earthquake Force (lbs)	Surcharge Load (lbs)
1	4.9	948.2	0.0	0.0	0.0	0.0
2	4.9	2681.7	0.0	0.0	0.0	0.0
3	4.8	4097.2	0.0	0.0	0.0	0.0
4	4.6	5178.2	0.0	0.0	0.0	0.0
5	4.5	5919.4	0.0	0.0	0.0	0.0
6	4.3	6325.9	0.0	0.0	0.0	0.0
7	0.2	244.6	0.0	0.0	0.0	0.0
8	4.0	5948.8	0.0	0.0	0.0	0.0
9	3.9	5560.8	0.0	0.0	0.0	0.0
10	3.7	4749.5	0.0	0.0	0.0	0.0
11	3.0	3429.0	0.0	0.0	0.0	0.0
12	0.4	374.0	0.0	0.0	0.0	0.0
13	3.1	2385.2	0.0	0.0	0.0	0.0
14	1.5	602.3	0.0	0.0	0.0	0.0
15	1.4	217.3	0.0	0.0	0.0	338.0
16	0.2	5.1	0.0	0.0	0.0	56.4

Failure Surface Specified By 14 Coordinate Points

Point No.	X-Surf (ft)	Y-Surf (ft)
1	96.400	28.700
2	101.341	29.465
3	106.212	30.594
4	110.986	32.081
5	115.636	33.918
6	120.137	36.095
7	124.465	38.600
8	128.594	41.418
9	132.503	44.536
10	136.171	47.935
11	139.576	51.596



12 142.700 55.500  
 13 145.526 59.625  
 14 145.775 60.053  
 Circle Center At X = 88.605 ; Y = 95.530 ; and Radius = 67.284  
 Factor of Safety  
 \*\*\* 1.527 \*\*\*

Failure Surface Specified By 14 Coordinate Points

Point No.	X-Surf (ft)	Y-Surf (ft)
1	96.400	28.700
2	101.344	29.447
3	106.218	30.562
4	110.995	32.038
5	115.649	33.866
6	120.153	36.038
7	124.481	38.540
8	128.611	41.359
9	132.518	44.479
10	136.181	47.882
11	139.580	51.550
12	142.695	55.461
13	145.508	59.594
14	145.773	60.053

Circle Center At X = 88.922 ; Y = 95.027 ; and Radius = 66.747  
 Factor of Safety  
 \*\*\* 1.527 \*\*\*

Failure Surface Specified By 14 Coordinate Points

Point No.	X-Surf (ft)	Y-Surf (ft)
1	96.400	28.700
2	101.342	29.462
3	106.216	30.577
4	110.997	32.040
5	115.660	33.843
6	120.182	35.977
7	124.539	38.430
8	128.708	41.191
9	132.668	44.244
10	136.398	47.573
11	139.878	51.163
12	143.092	54.993
13	146.022	59.045
14	146.658	60.073

Circle Center At X = 88.346 ; Y = 97.544 ; and Radius = 69.313  
 Factor of Safety  
 \*\*\* 1.527 \*\*\*

Failure Surface Specified By 14 Coordinate Points

Point No.	X-Surf (ft)	Y-Surf (ft)
1	96.400	28.700
2	101.342	29.459
3	106.216	30.573
4	110.998	32.034
5	115.662	33.836
6	120.184	35.969
7	124.541	38.422
8	128.710	41.182
9	132.670	44.236
10	136.399	47.566
11	139.879	51.156
12	143.092	54.988
13	146.020	59.041
14	146.658	60.073

Circle Center At X = 88.392 ; Y = 97.470 ; and Radius = 69.234  
 Factor of Safety  
 \*\*\* 1.527 \*\*\*

Failure Surface Specified By 14 Coordinate Points

Point No.	X-Surf (ft)	Y-Surf (ft)
1	96.400	28.700

2	101.345	29.436
3	106.224	30.531
4	111.010	31.977
5	115.679	33.768
6	120.204	35.894
7	124.563	38.343
8	128.732	41.103
9	132.690	44.160
10	136.414	47.495
11	139.886	51.094
12	143.087	54.935
13	146.000	58.999
14	146.657	60.073

Circle Center At X = 88.822 ; Y = 96.780 ; and Radius = 68.500  
 Factor of Safety  
 \*\*\* 1.527 \*\*\*

Failure Surface Specified By 14 Coordinate Points

Point No.	X-Surf (ft)	Y-Surf (ft)
1	96.400	28.700
2	101.351	29.395
3	106.236	30.462
4	111.027	31.894
5	115.696	33.683
6	120.216	35.820
7	124.563	38.291
8	128.711	41.083
9	132.636	44.180
10	136.317	47.564
11	139.732	51.216
12	142.862	55.115
13	145.689	59.239
14	146.165	60.062

Circle Center At X = 89.716 ; Y = 94.471 ; and Radius = 66.109  
 Factor of Safety  
 \*\*\* 1.528 \*\*\*

Failure Surface Specified By 14 Coordinate Points

Point No.	X-Surf (ft)	Y-Surf (ft)
1	96.400	28.700
2	101.321	29.587
3	106.169	30.810
4	110.922	32.361
5	115.558	34.234
6	120.055	36.421
7	124.391	38.910
8	128.547	41.690
9	132.503	44.748
10	136.240	48.070
11	139.740	51.640
12	142.988	55.441
13	145.968	59.456
14	146.360	60.067

Circle Center At X = 85.960 ; Y = 100.799 ; and Radius = 72.851  
 Factor of Safety  
 \*\*\* 1.528 \*\*\*

Failure Surface Specified By 14 Coordinate Points

Point No.	X-Surf (ft)	Y-Surf (ft)
1	96.400	28.700
2	101.346	29.434
3	106.221	30.544
4	110.997	32.024
5	115.646	33.865
6	120.140	36.057
7	124.453	38.587
8	128.559	41.439
9	132.436	44.597
10	136.059	48.043
11	139.408	51.755

12 142.462 55.714  
13 145.205 59.894  
14 145.286 60.042  
Circle Center At X = 89.313 ; Y = 93.551 ; and Radius = 65.237  
Factor of Safety  
\*\*\* 1.528 \*\*\*

Failure Surface Specified By 14 Coordinate Points

Point No.	X-Surf (ft)	Y-Surf (ft)
1	96.400	28.700
2	101.346	29.433
3	106.221	30.543
4	110.997	32.023
5	115.646	33.865
6	120.140	36.057
7	124.453	38.586
8	128.559	41.438
9	132.436	44.596
10	136.059	48.042
11	139.408	51.755
12	142.462	55.713
13	145.205	59.894
14	145.286	60.042

Circle Center At X = 89.316 ; Y = 93.546 ; and Radius = 65.232  
Factor of Safety  
\*\*\* 1.528 \*\*\*

\*\*\*\* END OF GSTABL7 OUTPUT \*\*\*\*

# 12091-01 / John S. Gibson / Sec. A-A' / Seismic

z:\2012\12091-01 howard industrial partners - john s gibson blvd\engineering\slope stability\sections\A-A'\axle.pl2 Run By: SHH 3/14/2019 12:24PM

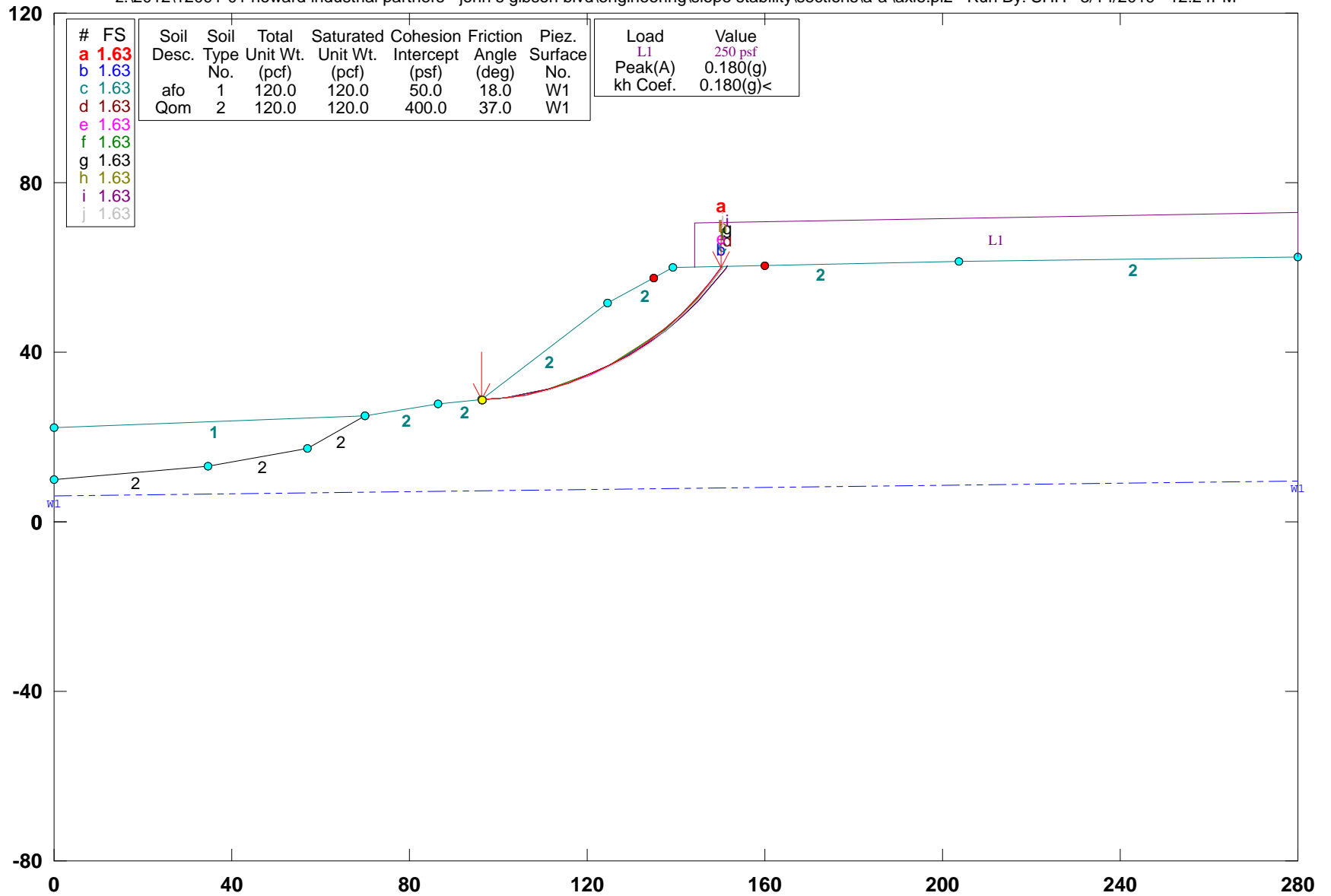

GSTABL7 v.2 FSmin=1.63  
 Safety Factors Are Calculated By The Modified Bishop Method

\*\*\* GSTABL7 \*\*\*

\*\* GSTABL7 by Dr. Garry H. Gregory, Ph.D., P.E., D.GE \*\*

\*\* Original Version 1.0, January 1996; Current Ver. 2.005.3, Feb. 2013 \*\*  
(All Rights Reserved-Unauthorized Use Prohibited)

SLOPE STABILITY ANALYSIS SYSTEM

Modified Bishop, Simplified Janbu, or GLE Method of Slices.  
(Includes Spencer & Morgenstern-Price Type Analysis)  
Including Pier/Pile, Reinforcement, Soil Nail, Tieback,  
Nonlinear Undrained Shear Strength, Curved Phi Envelope,  
Anisotropic Soil, Fiber-Reinforced Soil, Boundary Loads, Water  
Surfaces, Pseudo-Static & Newmark Earthquake, and Applied Forces.

\*\*\*\*\*  
Analysis Run Date: 3/14/2019  
Time of Run: 12:24PM  
Run By: SHH  
Input Data Filename: z:\2012\12091-01 Howard Industrial Partners - John S Gibson  
Blvd\Engineering\Slope Stability\Sections\A-A'\axle.in  
Output Filename: z:\2012\12091-01 Howard Industrial Partners - John S Gibson  
Blvd\Engineering\Slope Stability\Sections\A-A'\axle.OUT  
Unit System: English  
Plotted Output Filename: z:\2012\12091-01 Howard Industrial Partners - John S Gibson  
Blvd\Engineering\Slope Stability\Sections\A-A'\axle.PLT  
PROBLEM DESCRIPTION: 12091-01 / John S. Gibson / Sec. A-A' /  
Seismic

BOUNDARY COORDINATES  
7 Top Boundaries  
10 Total Boundaries

Boundary No.	X-Left (ft)	Y-Left (ft)	X-Right (ft)	Y-Right (ft)	Soil Type Below Bnd
1	0.00	22.30	69.90	24.90	1
2	69.90	24.90	86.50	27.90	2
3	86.50	27.90	96.40	28.70	2
4	96.40	28.70	124.60	51.50	2
5	124.60	51.50	139.20	59.90	2
6	139.20	59.90	203.70	61.40	2
7	203.70	61.40	280.00	62.60	2
8	0.00	10.00	34.80	13.20	2
9	34.80	13.20	57.20	17.20	2
10	57.20	17.20	69.90	24.90	2

Default Y-Origin = 0.00(ft)  
Default X-Plus Value = 0.00(ft)  
Default Y-Plus Value = 0.00(ft)

ISOTROPIC SOIL PARAMETERS

2 Type(s) of Soil		Soil Type	Total Unit Wt. (pcf)	Saturated Unit Wt. (pcf)	Cohesion (psf)	Friction Angle (deg)	Pore Pressure Param. (psf)	Piez. Surface No.
1	120.0	120.0	50.0	18.0	0.00	0.0	1	
2	120.0	120.0	400.0	37.0	0.00	0.0	1	

1 PIEZOMETRIC SURFACE(S) SPECIFIED

Unit Weight of Water = 62.40 (pcf)  
Piezometric Surface No. 1 Specified by 2 Coordinate Points  
Pore Pressure Inclination Factor = 0.50

Point No.	X-Water (ft)	Y-Water (ft)
1	0.00	6.10
2	280.00	9.70

BOUNDARY LOAD(S)

1 Load(s) Specified				
Load No.	X-Left (ft)	X-Right (ft)	Intensity (psf)	Deflection (deg)
1	144.20	280.00	250.0	0.0

NOTE - Intensity Is Specified As A Uniformly Distributed Force Acting On A Horizontally Projected Surface.  
Specified Peak Ground Acceleration Coefficient (A) = 0.180(g)  
Specified Horizontal Earthquake Coefficient (kh) = 0.180(g)  
Specified Vertical Earthquake Coefficient (kv) = 0.000(g)  
Specified Seismic Pore-Pressure Factor = 0.000  
A Critical Failure Surface Searching Method, Using A Random

Technique For Generating Circular Surfaces, Has Been Specified.  
5000 Trial Surfaces Have Been Generated.  
200 Surface(s) Initiate(s) From Each Of 25 Points Equally Spaced  
Along The Ground Surface Between X = 96.40(ft)  
and X = 96.40(ft)  
Each Surface Terminates Between X = 135.00(ft)  
and X = 160.00(ft)

Unless Further Limitations Were Imposed, The Minimum Elevation  
At Which A Surface Extends Is Y = 0.00(ft)  
5.00(ft) Line Segments Define Each Trial Failure Surface.  
Following Are Displayed The Ten Most Critical Of The Trial  
Failure Surfaces Evaluated. They Are  
Ordered - Most Critical First.

\* \* Safety Factors Are Calculated By The Modified Bishop Method \* \*  
Total Number of Trial Surfaces Attempted = 5000  
Number of Trial Surfaces With Valid FS = 5000  
Statistical Data On All Valid FS Values:  
FS Max = 4.439 FS Min = 1.626 FS Ave = 2.000  
Standard Deviation = 0.310 Coefficient of Variation = 15.52 %  
Failure Surface Specified By 14 Coordinate Points

Point No.	X-Surf (ft)	Y-Surf (ft)
1	96.400	28.700
2	101.375	29.195
3	106.302	30.048
4	111.155	31.253
5	115.908	32.806
6	120.536	34.696
7	125.017	36.916
8	129.325	39.453
9	133.440	42.294
10	137.339	45.424
11	141.002	48.827
12	144.410	52.486
13	147.546	56.380
14	150.160	60.155

Circle Center At X = 92.045 ; Y = 97.811 ; and Radius = 69.248

Factor of Safety  
\*\*\* 1.626 \*\*\*

Individual data on the 16 slices										
Slice No.	Width (ft)	Weight (lbs)	Water Force (lbs)		Tie Norm (lbs)	Tie Force (lbs)		Earthquake Force (lbs)		Surcharge Load (lbs)
			Top	Bot		Hor	Ver			
1	5.0	1053.0	0.0	0.0	0.0	0.0	0.0	189.5	0.0	0.0
2	4.9	3011.0	0.0	0.0	0.0	0.0	0.0	542.0	0.0	0.0
3	4.9	4668.4	0.0	0.0	0.0	0.0	0.0	840.3	0.0	0.0
4	4.8	6000.8	0.0	0.0	0.0	0.0	0.0	1080.2	0.0	0.0
5	4.6	6994.2	0.0	0.0	0.0	0.0	0.0	1259.0	0.0	0.0
6	4.1	6902.2	0.0	0.0	0.0	0.0	0.0	1242.4	0.0	0.0
7	0.4	740.2	0.0	0.0	0.0	0.0	0.0	133.2	0.0	0.0
8	4.3	7649.2	0.0	0.0	0.0	0.0	0.0	1376.9	0.0	0.0
9	4.1	7173.4	0.0	0.0	0.0	0.0	0.0	1291.2	0.0	0.0
10	3.9	6479.3	0.0	0.0	0.0	0.0	0.0	1166.3	0.0	0.0
11	1.9	2920.6	0.0	0.0	0.0	0.0	0.0	525.7	0.0	0.0
12	1.8	2579.6	0.0	0.0	0.0	0.0	0.0	464.3	0.0	0.0
13	3.2	3621.1	0.0	0.0	0.0	0.0	0.0	651.8	0.0	0.0
14	0.2	192.7	0.0	0.0	0.0	0.0	0.0	34.7	0.0	52.5
15	3.1	2116.4	0.0	0.0	0.0	0.0	0.0	381.0	0.0	783.9
16	2.6	582.5	0.0	0.0	0.0	0.0	0.0	104.8	0.0	653.5

Failure Surface Specified By 14 Coordinate Points

Point No.	X-Surf (ft)	Y-Surf (ft)
1	96.400	28.700
2	101.374	29.206
3	106.300	30.067
4	111.150	31.280
5	115.901	32.838
6	120.529	34.733
7	125.008	36.954

8 129.316 39.492  
 9 133.431 42.332  
 10 137.331 45.461  
 11 140.997 48.861  
 12 144.410 52.515  
 13 147.551 56.405  
 14 150.158 60.155

Circle Center At X = 91.866 ; Y = 98.113 ; and Radius = 69.561

Factor of Safety  
 \*\*\* 1.626 \*\*\*

Failure Surface Specified By 14 Coordinate Points

Point No.	X-Surf (ft)	Y-Surf (ft)
1	96.400	28.700
2	101.370	29.244
3	106.291	30.133
4	111.137	31.361
5	115.887	32.923
6	120.517	34.812
7	125.004	37.018
8	129.327	39.530
9	133.465	42.337
10	137.397	45.425
11	141.106	48.778
12	144.573	52.382
13	147.780	56.217
14	150.641	60.166

Circle Center At X = 91.069 ; Y = 100.374 ; and Radius = 71.872

Factor of Safety  
 \*\*\* 1.626 \*\*\*

Failure Surface Specified By 15 Coordinate Points

Point No.	X-Surf (ft)	Y-Surf (ft)
1	96.400	28.700
2	101.373	29.215
3	106.300	30.070
4	111.156	31.261
5	115.919	32.781
6	120.567	34.625
7	125.077	36.782
8	129.430	39.244
9	133.603	41.998
10	137.577	45.031
11	141.335	48.330
12	144.857	51.879
13	148.128	55.661
14	151.132	59.658
15	151.475	60.185

Circle Center At X = 91.377 ; Y = 101.442 ; and Radius = 72.915

Factor of Safety  
 \*\*\* 1.626 \*\*\*

Failure Surface Specified By 14 Coordinate Points

Point No.	X-Surf (ft)	Y-Surf (ft)
1	96.400	28.700
2	101.380	29.150
3	106.313	29.965
4	111.173	31.141
5	115.933	32.670
6	120.568	34.544
7	125.053	36.755
8	129.364	39.288
9	133.477	42.132
10	137.369	45.270
11	141.021	48.686
12	144.411	52.360
13	147.523	56.274
14	150.168	60.155

Circle Center At X = 92.781 ; Y = 96.569 ; and Radius = 67.965

Factor of Safety

\*\*\* 1.626 \*\*\*

Failure Surface Specified By 14 Coordinate Points

Point No.	X-Surf (ft)	Y-Surf (ft)
1	96.400	28.700
2	101.369	29.257
3	106.287	30.156
4	111.132	31.392
5	115.880	32.961
6	120.507	34.854
7	124.993	37.063
8	129.316	39.576
9	133.454	42.382
10	137.389	45.467
11	141.100	48.817
12	144.572	52.416
13	147.786	56.246
14	150.639	60.166

Circle Center At X = 90.846 ; Y = 100.753 ; and Radius = 72.267

Factor of Safety  
 \*\*\* 1.626 \*\*\*

Failure Surface Specified By 15 Coordinate Points

Point No.	X-Surf (ft)	Y-Surf (ft)
1	96.400	28.700
2	101.373	29.221
3	106.298	30.081
4	111.153	31.276
5	115.916	32.799
6	120.563	34.645
7	125.073	36.804
8	129.424	39.266
9	133.598	42.020
10	137.573	45.052
11	141.332	48.349
12	144.856	51.896
13	148.130	55.675
14	151.138	59.669
15	151.475	60.185

Circle Center At X = 91.270 ; Y = 101.627 ; and Radius = 73.107

Factor of Safety  
 \*\*\* 1.626 \*\*\*

Failure Surface Specified By 14 Coordinate Points

Point No.	X-Surf (ft)	Y-Surf (ft)
1	96.400	28.700
2	101.369	29.260
3	106.287	30.161
4	111.131	31.399
5	115.878	32.970
6	120.505	34.864
7	124.991	37.073
8	129.313	39.586
9	133.452	42.392
10	137.387	45.477
11	141.099	48.826
12	144.572	52.423
13	147.787	56.252
14	150.638	60.166

Circle Center At X = 90.796 ; Y = 100.838 ; and Radius = 72.355

Factor of Safety  
 \*\*\* 1.626 \*\*\*

Failure Surface Specified By 15 Coordinate Points

Point No.	X-Surf (ft)	Y-Surf (ft)
1	96.400	28.700
2	101.372	29.232
3	106.295	30.101
4	111.149	31.303
5	115.909	32.833

6	120.555	34.682
7	125.063	36.844
8	129.415	39.307
9	133.588	42.060
10	137.565	45.090
11	141.327	48.385
12	144.855	51.927
13	148.135	55.701
14	151.150	59.690
15	151.474	60.185

Circle Center At X = 91.070 ; Y = 101.974 ; and Radius = 73.468

Factor of Safety  
\*\*\* 1.626 \*\*\*

Failure Surface Specified By 15 Coordinate Points

Point No.	X-Surf (ft)	Y-Surf (ft)
1	96.400	28.700
2	101.382	29.123
3	106.320	29.911
4	111.186	31.058
5	115.955	32.561
6	120.601	34.409
7	125.099	36.593
8	129.424	39.102
9	133.553	41.921
10	137.464	45.036
11	141.136	48.429
12	144.549	52.084
13	147.685	55.978
14	150.526	60.093
15	150.568	60.164

Circle Center At X = 93.138 ; Y = 96.681 ; and Radius = 68.060

Factor of Safety  
\*\*\* 1.626 \*\*\*

\*\*\*\* END OF GSTABL7 OUTPUT \*\*\*\*

# 12091-01 / John S. Gibson / Sec. B-B' / Static

z:\2012\12091-01 howard industrial partners - john s gibson blvd\engineering\slope stability\sections\b-b'\b\l.pl2 Run By: SHH 3/14/2019 12:27PM

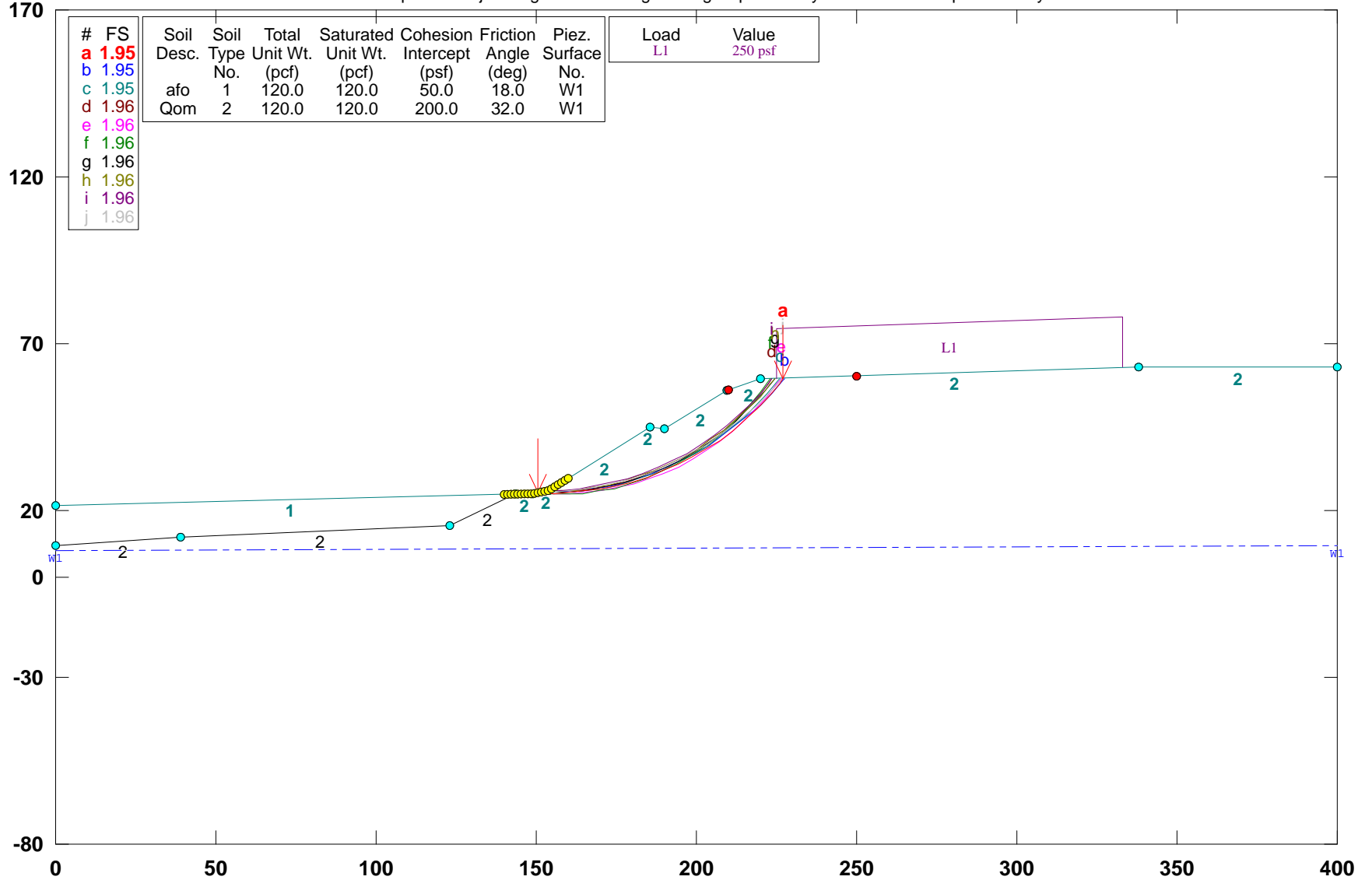

GSTABL7 v.2 FSmin=1.95  
 Safety Factors Are Calculated By The Modified Bishop Method

\*\*\* GSTABL7 \*\*\*

\*\* GSTABL7 by Dr. Garry H. Gregory, Ph.D., P.E., D.GE \*\*
\*\* Original Version 1.0, January 1996; Current Ver. 2.005.3, Feb. 2013 \*\*
(All Rights Reserved-Unauthorized Use Prohibited)

SLOPE STABILITY ANALYSIS SYSTEM

Modified Bishop, Simplified Janbu, or GLE Method of Slices.
(Includes Spencer & Morgenstern-Price Type Analysis)
Including Pier/Pile, Reinforcement, Soil Nail, Tieback,
Nonlinear Undrained Shear Strength, Curved Phi Envelope,
Anisotropic Soil, Fiber-Reinforced Soil, Boundary Loads, Water
Surfaces, Pseudo-Static & Newmark Earthquake, and Applied Forces.

Analysis Run Date: 3/14/2019
Time of Run: 12:27PM
Run By: SHH

Input Data Filename: z:\2012\12091-01 Howard Industrial Partners - John S Gibson
Blvd\Engineering\Slope Stability\Sections\B-B'\bxl.in
Output Filename: z:\2012\12091-01 Howard Industrial Partners - John S Gibson
Blvd\Engineering\Slope Stability\Sections\B-B'\bxl.OUT
Unit System: English
Plotted Output Filename: z:\2012\12091-01 Howard Industrial Partners - John S Gibson
Blvd\Engineering\Slope Stability\Sections\B-B'\bxl.PLT

PROBLEM DESCRIPTION: 12091-01 / John S. Gibson / Sec. B-B' /
Static

BOUNDARY COORDINATES
9 Top Boundaries
12 Total Boundaries

Table with columns: Boundary No., X-Left (ft), Y-Left (ft), X-Right (ft), Y-Right (ft), Soil Type Below Bnd. Rows 1-12.

Default Y-Origin = 0.00(ft)
Default X-Plus Value = 0.00(ft)
Default Y-Plus Value = 0.00(ft)

ISOTROPIC SOIL PARAMETERS

Table with columns: Type, Unit Wt., Saturated Unit Wt., Cohesion, Friction Angle, Pore Pressure, Piez. Surface. Rows 1-2.

1 PIEZOMETRIC SURFACE(S) SPECIFIED

Unit Weight of Water = 62.40 (pcf)
Piezometric Surface No. 1 Specified by 2 Coordinate Points
Pore Pressure Inclination Factor = 0.50

Table with columns: Point No., X-Water (ft), Y-Water (ft). Rows 1-2.

BOUNDARY LOAD(S)

Table with columns: Load No., X-Left (ft), X-Right (ft), Intensity (psf), Deflection (deg). Rows 1-1.

NOTE - Intensity Is Specified As A Uniformly Distributed Force Acting On A Horizontally Projected Surface.

A Critical Failure Surface Searching Method, Using A Random Technique For Generating Circular Surfaces, Has Been Specified.
5000 Trial Surfaces Have Been Generated.

250 Surface(s) Initiate(s) From Each Of 20 Points Equally Spaced
Along The Ground Surface Between X = 140.00(ft)
and X = 160.00(ft)
Each Surface Terminates Between X = 210.00(ft)
and X = 250.00(ft)

Unless Further Limitations Were Imposed, The Minimum Elevation
At Which A Surface Extends Is Y = 0.00(ft)
5.00(ft) Line Segments Define Each Trial Failure Surface.
Following Are Displayed The Ten Most Critical Of The Trial
Failure Surfaces Evaluated. They Are
Ordered - Most Critical First.

\* \* Safety Factors Are Calculated By The Modified Bishop Method \* \*
Total Number of Trial Surfaces Attempted = 5000
Number of Trial Surfaces With Valid FS = 5000
Statistical Data On All Valid FS Values:

FS Max = 4.841 FS Min = 1.952 FS Ave = 2.669
Standard Deviation = 0.462 Coefficient of Variation = 17.32 %
Failure Surface Specified By 19 Coordinate Points

Table with columns: Point No., X-Surf (ft), Y-Surf (ft). Rows 1-19.

Circle Center At X = 155.110 ; Y = 118.292 ; and Radius = 93.066

Factor of Safety = 1.952

Individual data on the 24 slices

Table with columns: Slice No., Width (ft), Weight (lbs), Water Force Top (lbs), Water Force Bot (lbs), Tie Force Norm (lbs), Tie Force Tan (lbs), Earthquake Force Hor (lbs), Earthquake Force Ver (lbs), Surcharge Load (lbs). Rows 1-23.



24 1.3 130.4 0.0 0.0 0. 0. 0.0 0.0 335.6

Failure Surface Specified By 19 Coordinate Points

Point No.	X-Surf (ft)	Y-Surf (ft)
1	151.579	25.545
2	156.579	25.571
3	161.571	25.855
4	166.541	26.395
5	171.478	27.191
6	176.366	28.240
7	181.195	29.540
8	185.949	31.086
9	190.618	32.876
10	195.189	34.903
11	199.648	37.164
12	203.986	39.651
13	208.190	42.358
14	212.248	45.279
15	216.151	48.404
16	219.887	51.727
17	223.448	55.237
18	226.822	58.927
19	227.319	59.530

Circle Center At X = 153.572 ; Y = 122.543 ; and Radius = 97.019

Factor of Safety  
\*\*\* 1.952 \*\*\*

Failure Surface Specified By 19 Coordinate Points

Point No.	X-Surf (ft)	Y-Surf (ft)
1	150.526	25.338
2	155.526	25.255
3	160.522	25.444
4	165.501	25.907
5	170.446	26.642
6	175.344	27.646
7	180.180	28.916
8	184.940	30.449
9	189.608	32.240
10	194.171	34.284
11	198.616	36.574
12	202.928	39.105
13	207.096	41.867
14	211.106	44.853
15	214.947	48.054
16	218.608	51.460
17	222.076	55.062
18	225.342	58.847
19	225.833	59.483

Circle Center At X = 154.557 ; Y = 116.615 ; and Radius = 91.366

Factor of Safety  
\*\*\* 1.954 \*\*\*

Failure Surface Specified By 18 Coordinate Points

Point No.	X-Surf (ft)	Y-Surf (ft)
1	152.632	25.751
2	157.631	25.779
3	162.622	26.093
4	167.586	26.691
5	172.508	27.571
6	177.371	28.731
7	182.161	30.167
8	186.860	31.873
9	191.455	33.845
10	195.930	36.077
11	200.270	38.560
12	204.461	41.286
13	208.489	44.248
14	212.342	47.434
15	216.007	50.836
16	219.472	54.441

17 222.725 58.238

18 223.621 59.414

Circle Center At X = 154.667 ; Y = 113.143 ; and Radius = 87.415

Factor of Safety  
\*\*\* 1.955 \*\*\*

Failure Surface Specified By 19 Coordinate Points

Point No.	X-Surf (ft)	Y-Surf (ft)
1	150.526	25.338
2	155.517	25.038
3	160.517	25.032
4	165.509	25.321
5	170.475	25.905
6	175.397	26.780
7	180.260	27.944
8	185.045	29.393
9	189.737	31.122
10	194.318	33.125
11	198.773	35.395
12	203.087	37.924
13	207.244	40.702
14	211.229	43.722
15	215.030	46.971
16	218.632	50.438
17	222.023	54.113
18	225.191	57.980
19	226.291	59.497

Circle Center At X = 158.115 ; Y = 109.696 ; and Radius = 84.698

Factor of Safety  
\*\*\* 1.956 \*\*\*

Failure Surface Specified By 18 Coordinate Points

Point No.	X-Surf (ft)	Y-Surf (ft)
1	149.474	25.132
2	154.465	24.833
3	159.465	24.846
4	164.454	25.169
5	169.414	25.803
6	174.325	26.744
7	179.167	27.990
8	183.923	29.534
9	188.573	31.371
10	193.100	33.494
11	197.485	35.895
12	201.713	38.564
13	205.767	41.492
14	209.630	44.665
15	213.289	48.074
16	216.728	51.703
17	219.934	55.540
18	222.762	59.387

Circle Center At X = 156.768 ; Y = 105.053 ; and Radius = 80.253

Factor of Safety  
\*\*\* 1.956 \*\*\*

Failure Surface Specified By 18 Coordinate Points

Point No.	X-Surf (ft)	Y-Surf (ft)
1	150.526	25.338
2	155.526	25.283
3	160.521	25.506
4	165.496	26.008
5	170.435	26.786
6	175.323	27.838
7	180.145	29.161
8	184.885	30.751
9	189.530	32.602
10	194.064	34.710
11	198.473	37.067
12	202.745	39.666
13	206.865	42.499

14	210.820	45.558
15	214.599	48.832
16	218.189	52.312
17	221.580	55.987
18	224.426	59.439

Circle Center At X = 154.031 ; Y = 114.869 ; and Radius = 89.599

Factor of Safety

\*\*\* 1.956 \*\*\*

Failure Surface Specified By 18 Coordinate Points

Point No.	X-Surf (ft)	Y-Surf (ft)
-----------	-------------	-------------

1	152.632	25.751
2	157.631	25.835
3	162.618	26.192
4	167.578	26.822
5	172.497	27.722
6	177.358	28.890
7	182.149	30.323
8	186.853	32.015
9	191.458	33.963
10	195.950	36.160
11	200.315	38.599
12	204.539	41.274
13	208.611	44.175
14	212.518	47.296
15	216.248	50.625
16	219.791	54.154
17	223.134	57.871
18	224.396	59.438

Circle Center At X = 153.637 ; Y = 116.894 ; and Radius = 91.148

Factor of Safety

\*\*\* 1.957 \*\*\*

Failure Surface Specified By 18 Coordinate Points

Point No.	X-Surf (ft)	Y-Surf (ft)
-----------	-------------	-------------

1	153.684	25.958
2	158.681	26.126
3	163.662	26.569
4	168.610	27.283
5	173.513	28.267
6	178.354	29.518
7	183.119	31.032
8	187.794	32.805
9	192.365	34.831
10	196.818	37.104
11	201.141	39.618
12	205.319	42.365
13	209.340	45.336
14	213.193	48.523
15	216.865	51.916
16	220.346	55.505
17	223.626	59.279
18	223.733	59.417

Circle Center At X = 153.108 ; Y = 117.219 ; and Radius = 91.263

Factor of Safety

\*\*\* 1.957 \*\*\*

Failure Surface Specified By 19 Coordinate Points

Point No.	X-Surf (ft)	Y-Surf (ft)
-----------	-------------	-------------

1	150.526	25.338
2	155.525	25.449
3	160.512	25.805
4	165.476	26.407
5	170.404	27.251
6	175.285	28.337
7	180.106	29.662
8	184.857	31.222
9	189.525	33.013
10	194.099	35.033
11	198.568	37.274

12	202.922	39.733
13	207.149	42.403
14	211.240	45.278
15	215.185	48.350
16	218.974	51.613
17	222.597	55.058
18	226.047	58.677
19	226.768	59.512

Circle Center At X = 150.778 ; Y = 126.975 ; and Radius = 101.637

Factor of Safety

\*\*\* 1.957 \*\*\*

\*\*\*\* END OF GSTABL7 OUTPUT \*\*\*\*

# 12091-01 / John S. Gibson / Sec. B-B' / Seismic

z:\2012\12091-01 howard industrial partners - john s gibson blvd\engineering\slope stability\sections\b-b'\bxle.pl2 Run By: SHH 3/14/2019 12:28PM

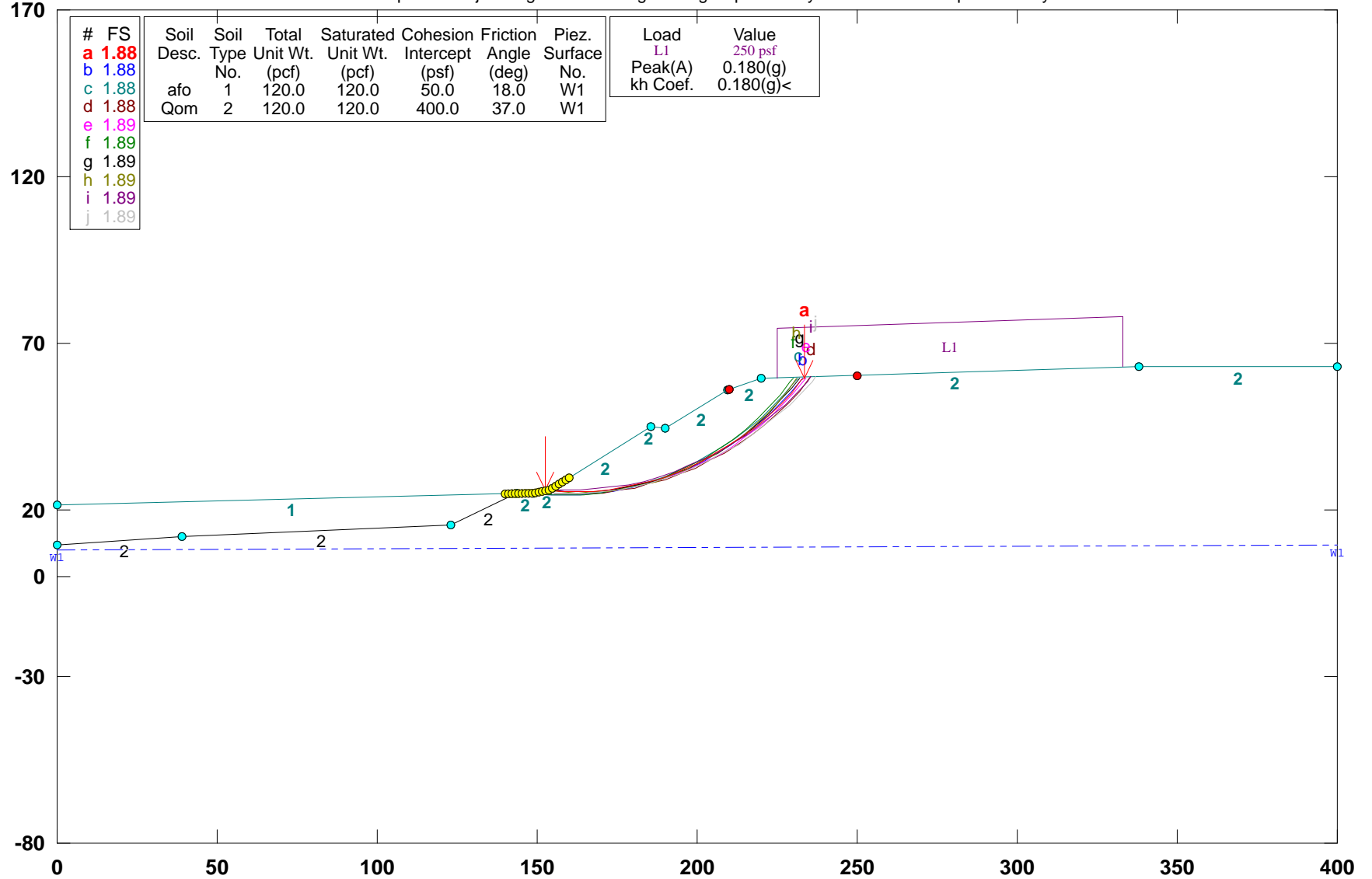

GSTABL7 v.2 FSmin=1.88

Safety Factors Are Calculated By The Modified Bishop Method

\*\*\* GSTABL7 \*\*\*

\*\* GSTABL7 by Dr. Garry H. Gregory, Ph.D., P.E., D.GE \*\*  
 \*\* Original Version 1.0, January 1996; Current Ver. 2.005.3, Feb. 2013 \*\*  
 (All Rights Reserved-Unauthorized Use Prohibited)

\*\*\*\*\*

SLOPE STABILITY ANALYSIS SYSTEM

Modified Bishop, Simplified Janbu, or GLE Method of Slices.  
 (Includes Spencer & Morgenstern-Price Type Analysis)  
 Including Pier/Pile, Reinforcement, Soil Nail, Tieback,  
 Nonlinear Undrained Shear Strength, Curved Phi Envelope,  
 Anisotropic Soil, Fiber-Reinforced Soil, Boundary Loads, Water  
 Surfaces, Pseudo-Static & Newmark Earthquake, and Applied Forces.

\*\*\*\*\*

Analysis Run Date: 3/14/2019  
 Time of Run: 12:28PM  
 Run By: SHH  
 Input Data Filename: z:\2012\12091-01 Howard Industrial Partners - John S Gibson  
 Blvd\Engineering\Slope Stability\Sections\B-B'\bxle.in  
 Output Filename: z:\2012\12091-01 Howard Industrial Partners - John S Gibson  
 Blvd\Engineering\Slope Stability\Sections\B-B'\bxle.OUT  
 Unit System: English  
 Plotted Output Filename: z:\2012\12091-01 Howard Industrial Partners - John S Gibson  
 Blvd\Engineering\Slope Stability\Sections\B-B'\bxle.PLT  
 PROBLEM DESCRIPTION: 12091-01 / John S. Gibson / Sec. B-B' /  
 Seismic

BOUNDARY COORDINATES

9 Top Boundaries					
12 Total Boundaries					
Boundary No.	X-Left (ft)	Y-Left (ft)	X-Right (ft)	Y-Right (ft)	Soil Type Below Bnd
1	0.00	21.50	143.50	24.90	1
2	143.50	24.90	148.80	25.00	2
3	148.80	25.00	153.90	26.00	2
4	153.90	26.00	185.70	45.00	2
5	185.70	45.00	190.00	44.50	2
6	190.00	44.50	209.50	56.00	2
7	209.50	56.00	220.00	59.30	2
8	220.00	59.30	338.00	63.00	2
9	338.00	63.00	400.00	63.00	2
10	0.00	9.60	39.00	12.10	2
11	39.00	12.10	123.10	15.30	2
12	123.10	15.30	143.50	24.90	2

Default Y-Origin = 0.00(ft)  
 Default X-Plus Value = 0.00(ft)  
 Default Y-Plus Value = 0.00(ft)

ISOTROPIC SOIL PARAMETERS

2 Type(s) of Soil							
Soil Type No.	Total (pcf)	Saturated (pcf)	Cohesion (psf)	Friction Angle (deg)	Pore Pressure Param. (psf)	Pressure Constant (psf)	Piez. Surface No.
1	120.0	120.0	50.0	18.0	0.00	0.0	1
2	120.0	120.0	400.0	37.0	0.00	0.0	1

1 PIEZOMETRIC SURFACE(S) SPECIFIED

Unit Weight of Water = 62.40 (pcf)  
 Piezometric Surface No. 1 Specified by 2 Coordinate Points  
 Pore Pressure Inclination Factor = 0.50

Point No.	X-Water (ft)	Y-Water (ft)
1	0.00	7.80
2	400.00	9.70

BOUNDARY LOAD(S)

1 Load(s) Specified				
Load No.	X-Left (ft)	X-Right (ft)	Intensity (psf)	Deflection (deg)
1	225.00	333.00	250.0	0.0

NOTE - Intensity Is Specified As A Uniformly Distributed Force Acting On A Horizontally Projected Surface.

Specified Peak Ground Acceleration Coefficient (A) = 0.180(g)  
 Specified Horizontal Earthquake Coefficient (kh) = 0.180(g)  
 Specified Vertical Earthquake Coefficient (kv) = 0.000(g)

Specified Seismic Pore-Pressure Factor = 0.000  
 A Critical Failure Surface Searching Method, Using A Random  
 Technique For Generating Circular Surfaces, Has Been Specified.  
 5000 Trial Surfaces Have Been Generated.  
 250 Surface(s) Initiate(s) From Each Of 20 Points Equally Spaced  
 Along The Ground Surface Between X = 140.00(ft)  
 and X = 160.00(ft)  
 Each Surface Terminates Between X = 210.00(ft)  
 and X = 250.00(ft)

Unless Further Limitations Were Imposed, The Minimum Elevation  
 At Which A Surface Extends Is Y = 0.00(ft)  
 5.00(ft) Line Segments Define Each Trial Failure Surface.  
 Following Are Displayed The Ten Most Critical Of The Trial  
 Failure Surfaces Evaluated. They Are  
 Ordered - Most Critical First.

\* \* Safety Factors Are Calculated By The Modified Bishop Method \* \*

Total Number of Trial Surfaces Attempted = 5000  
 Number of Trial Surfaces With Valid FS = 5000  
 Statistical Data On All Valid FS Values:  
 FS Max = 2.6366 FS Min = 1.883 FS Ave = 2.429  
 Standard Deviation = 0.399 Coefficient of Variation = 16.44 %  
 Failure Surface Specified By 20 Coordinate Points

Point No.	X-Surf (ft)	Y-Surf (ft)
1	152.632	25.751
2	157.622	25.447
3	162.622	25.408
4	167.617	25.635
5	172.593	26.128
6	177.535	26.885
7	182.430	27.904
8	187.264	29.182
9	192.023	30.716
10	196.694	32.500
11	201.263	34.531
12	205.717	36.801
13	210.045	39.306
14	214.233	42.038
15	218.270	44.988
16	222.144	48.149
17	225.844	51.512
18	229.360	55.067
19	232.682	58.803
20	233.414	59.721

Circle Center At X = 160.865 ; Y = 119.210 ; and Radius = 93.821

Factor of Safety

\*\*\* 1.883 \*\*\*

Individual data on the 25 slices

Slice No.	Width (ft)	Weight (lbs)	Water Force (lbs)		Tie Force Norm (lbs)	Tie Force (lbs)		Earthquake Force (lbs)		Surcharge Load (lbs)
			Top	Bot		Hor	Ver	Hor	Ver	
1	1.3	24.8	0.0	0.0	0.0	0.0	4.5	0.0	0.0	
2	3.7	693.1	0.0	0.0	0.0	0.0	124.8	0.0	0.0	
3	5.0	2574.2	0.0	0.0	0.0	0.0	463.4	0.0	0.0	
4	5.0	4304.7	0.0	0.0	0.0	0.0	774.8	0.0	0.0	
5	5.0	5851.5	0.0	0.0	0.0	0.0	1053.3	0.0	0.0	
6	4.9	7199.0	0.0	0.0	0.0	0.0	1295.8	0.0	0.0	
7	4.9	8334.8	0.0	0.0	0.0	0.0	1500.3	0.0	0.0	
8	3.3	6155.4	0.0	0.0	0.0	0.0	1108.0	0.0	0.0	
9	1.6	2990.3	0.0	0.0	0.0	0.0	538.2	0.0	0.0	
10	2.7	4936.8	0.0	0.0	0.0	0.0	888.6	0.0	0.0	
11	2.0	3570.2	0.0	0.0	0.0	0.0	642.6	0.0	0.0	
12	4.7	8666.4	0.0	0.0	0.0	0.0	1560.0	0.0	0.0	
13	4.6	8925.9	0.0	0.0	0.0	0.0	1606.7	0.0	0.0	
14	4.5	8974.9	0.0	0.0	0.0	0.0	1615.5	0.0	0.0	
15	3.8	7711.3	0.0	0.0	0.0	0.0	1388.0	0.0	0.0	
16	0.5	1107.3	0.0	0.0	0.0	0.0	199.3	0.0	0.0	
17	4.2	8120.2	0.0	0.0	0.0	0.0	1461.6	0.0	0.0	
18	4.0	7076.7	0.0	0.0	0.0	0.0	1273.8	0.0	0.0	

19	1.7	2768.9	0.0	0.0	0.	0.	498.4	0.0	0.0
20	2.1	3101.9	0.0	0.0	0.	0.	558.3	0.0	0.0
21	2.9	3415.8	0.0	0.0	0.	0.	614.8	0.0	0.0
22	0.8	844.7	0.0	0.0	0.	0.	152.0	0.0	211.0
23	3.5	2636.8	0.0	0.0	0.	0.	474.6	0.0	879.0
24	3.3	1080.5	0.0	0.0	0.	0.	194.5	0.0	830.5
25	0.7	39.3	0.0	0.0	0.	0.	7.1	0.0	182.9

Failure Surface Specified By 21 Coordinate Points

Point No.	X-Surf (ft)	Y-Surf (ft)
1	148.421	24.993
2	153.403	24.564
3	158.400	24.397
4	163.399	24.493
5	168.386	24.851
6	173.348	25.471
7	178.270	26.350
8	183.139	27.486
9	187.942	28.877
10	192.665	30.517
11	197.295	32.404
12	201.820	34.530
13	206.227	36.892
14	210.505	39.482
15	214.640	42.292
16	218.622	45.316
17	222.440	48.545
18	226.083	51.969
19	229.541	55.581
20	232.805	59.369
21	233.069	59.710

Circle Center At X = 159.075 ; Y = 119.597 ; and Radius = 95.202

Factor of Safety  
\*\*\* 1.884 \*\*\*

Failure Surface Specified By 20 Coordinate Points

Point No.	X-Surf (ft)	Y-Surf (ft)
1	150.526	25.338
2	155.515	25.008
3	160.515	24.948
4	165.511	25.158
5	170.488	25.636
6	175.432	26.383
7	180.328	27.396
8	185.163	28.671
9	189.921	30.205
10	194.590	31.994
11	199.156	34.033
12	203.605	36.315
13	207.924	38.833
14	212.101	41.581
15	216.124	44.551
16	219.981	47.733
17	223.660	51.119
18	227.151	54.698
19	230.444	58.461
20	231.382	59.657

Circle Center At X = 159.151 ; Y = 117.427 ; and Radius = 92.491

Factor of Safety  
\*\*\* 1.884 \*\*\*

Failure Surface Specified By 21 Coordinate Points

Point No.	X-Surf (ft)	Y-Surf (ft)
1	150.526	25.338
2	155.509	24.927
3	160.507	24.773
4	165.506	24.876
5	170.493	25.237
6	175.455	25.854
7	180.378	26.726

8	185.250	27.850
9	190.057	29.224
10	194.788	30.844
11	199.428	32.705
12	203.967	34.803
13	208.392	37.132
14	212.690	39.686
15	216.852	42.458
16	220.865	45.440
17	224.719	48.625
18	228.404	52.005
19	231.909	55.570
20	235.227	59.311
21	235.609	59.789

Circle Center At X = 161.001 ; Y = 121.797 ; and Radius = 97.026

Factor of Safety  
\*\*\* 1.884 \*\*\*

Failure Surface Specified By 20 Coordinate Points

Point No.	X-Surf (ft)	Y-Surf (ft)
1	153.684	25.958
2	158.669	25.573
3	163.668	25.465
4	168.665	25.633
5	173.646	26.077
6	178.594	26.796
7	183.494	27.787
8	188.333	29.047
9	193.094	30.573
10	197.764	32.360
11	202.328	34.402
12	206.772	36.694
13	211.083	39.227
14	215.247	41.995
15	219.251	44.989
16	223.084	48.200
17	226.734	51.617
18	230.189	55.231
19	233.439	59.031
20	233.980	59.738

Circle Center At X = 163.140 ; Y = 115.802 ; and Radius = 90.340

Factor of Safety  
\*\*\* 1.886 \*\*\*

Failure Surface Specified By 20 Coordinate Points

Point No.	X-Surf (ft)	Y-Surf (ft)
1	149.474	25.132
2	154.455	24.697
3	159.452	24.546
4	164.451	24.679
5	169.433	25.095
6	174.384	25.794
7	179.288	26.773
8	184.127	28.028
9	188.888	29.556
10	193.555	31.352
11	198.111	33.410
12	202.544	35.723
13	206.838	38.284
14	210.980	41.085
15	214.957	44.116
16	218.754	47.368
17	222.361	50.831
18	225.766	54.493
19	228.957	58.342
20	229.892	59.610

Circle Center At X = 159.630 ; Y = 112.468 ; and Radius = 87.924

Factor of Safety  
\*\*\* 1.887 \*\*\*

Failure Surface Specified By 19 Coordinate Points

Point No.	X-Surf (ft)	Y-Surf (ft)
1	153.684	25.958
2	158.667	25.548
3	163.666	25.429
4	168.663	25.601
5	173.641	26.064
6	178.585	26.816
7	183.476	27.855
8	188.298	29.176
9	193.035	30.776
10	197.671	32.648
11	202.190	34.788
12	206.577	37.187
13	210.817	39.837
14	214.895	42.729
15	218.799	45.854
16	222.513	49.201
17	226.027	52.759
18	229.327	56.515
19	231.790	59.670

Circle Center At X = 163.207 ; Y = 111.289 ; and Radius = 85.861

Factor of Safety  
\*\*\* 1.887 \*\*\*

Failure Surface Specified By 19 Coordinate Points

Point No.	X-Surf (ft)	Y-Surf (ft)
1	152.632	25.751
2	157.610	25.290
3	162.607	25.123
4	167.606	25.252
5	172.588	25.676
6	177.536	26.393
7	182.433	27.402
8	187.262	28.698
9	192.007	30.277
10	196.649	32.133
11	201.174	34.260
12	205.565	36.651
13	209.808	39.297
14	213.887	42.189
15	217.787	45.317
16	221.497	48.670
17	225.001	52.236
18	228.289	56.003
19	231.110	59.648

Circle Center At X = 162.926 ; Y = 109.738 ; and Radius = 84.615

Factor of Safety  
\*\*\* 1.887 \*\*\*

Failure Surface Specified By 20 Coordinate Points

Point No.	X-Surf (ft)	Y-Surf (ft)
1	153.684	25.958
2	158.682	25.813
3	163.681	25.912
4	168.669	26.253
5	173.635	26.835
6	178.567	27.658
7	183.454	28.718
8	188.283	30.015
9	193.043	31.544
10	197.724	33.302
11	202.313	35.286
12	206.802	37.489
13	211.178	39.908
14	215.431	42.536
15	219.552	45.368
16	223.531	48.396
17	227.359	51.613
18	231.025	55.012

19	234.523	58.585
20	235.592	59.789

Circle Center At X = 159.177 ; Y = 128.728 ; and Radius = 102.917

Factor of Safety  
\*\*\* 1.887 \*\*\*

Failure Surface Specified By 21 Coordinate Points

Point No.	X-Surf (ft)	Y-Surf (ft)
1	150.526	25.338
2	155.517	25.032
3	160.516	24.965
4	165.513	25.139
5	170.496	25.553
6	175.453	26.206
7	180.373	27.097
8	185.245	28.222
9	190.057	29.581
10	194.798	31.170
11	199.457	32.984
12	204.024	35.020
13	208.487	37.274
14	212.837	39.739
15	217.063	42.411
16	221.156	45.283
17	225.107	48.348
18	228.905	51.599
19	232.543	55.029
20	236.012	58.630
21	237.065	59.835

Circle Center At X = 159.398 ; Y = 128.956 ; and Radius = 103.997

Factor of Safety  
\*\*\* 1.887 \*\*\*

\*\*\*\* END OF GSTABL7 OUTPUT \*\*\*\*



\*\*\* GSTABL7 \*\*\*

\*\* GSTABL7 by Dr. Garry H. Gregory, Ph.D., P.E., D.GE \*\*
\*\* Original Version 1.0, January 1996; Current Ver. 2.005.3, Feb. 2013 \*\*
(All Rights Reserved-Unauthorized Use Prohibited)

SLOPE STABILITY ANALYSIS SYSTEM

Modified Bishop, Simplified Janbu, or GLE Method of Slices.
(Includes Spencer & Morgenstern-Price Type Analysis)
Including Pier/Pile, Reinforcement, Soil Nail, Tieback,
Nonlinear Undrained Shear Strength, Curved Phi Envelope,
Anisotropic Soil, Fiber-Reinforced Soil, Boundary Loads, Water
Surfaces, Pseudo-Static & Newmark Earthquake, and Applied Forces.

Analysis Run Date: 3/14/2019
Time of Run: 12:30PM
Run By: SHH

Input Data Filename: z:\2012\12091-01 Howard Industrial Partners - John S Gibson
Blvd\Engineering\Slope Stability\Sections\C-C'\cx12.in
Output Filename: z:\2012\12091-01 Howard Industrial Partners - John S Gibson
Blvd\Engineering\Slope Stability\Sections\C-C'\cx12.OUT
Unit System: English
Plotted Output Filename: z:\2012\12091-01 Howard Industrial Partners - John S Gibson
Blvd\Engineering\Slope Stability\Sections\C-C'\cx12.PLT
PROBLEM DESCRIPTION: 12091-01 / John S. Gibson / Sec. C-C' /
Static / Keyway 20'

BOUNDARY COORDINATES
13 Top Boundaries
23 Total Boundaries

Table with 6 columns: Boundary No., X-Left (ft), Y-Left (ft), X-Right (ft), Y-Right (ft), Soil Type Below Bnd. Lists 23 boundary points with their respective coordinates and soil types.

Default Y-Origin = 0.00(ft)
Default X-Plus Value = 0.00(ft)
Default Y-Plus Value = 0.00(ft)

ISOTROPIC SOIL PARAMETERS

Table with 7 columns: Soil Type, Total Unit Wt. (pcf), Saturated Unit Wt. (pcf), Cohesion (pcf), Friction Angle (deg), Pore Pressure Param. (psf), Piez. Surface No. Lists 3 soil types with their parameters.

1 PIEZOMETRIC SURFACE(S) SPECIFIED

Unit Weight of Water = 62.40 (pcf)
Piezometric Surface No. 1 Specified by 2 Coordinate Points
Pore Pressure Inclination Factor = 0.50
Point X-Water Y-Water
No. (ft) (ft)
1 0.00 9.80

2 440.00 11.50
BOUNDARY LOAD(S)

Table with 5 columns: Load No., X-Left (ft), X-Right (ft), Intensity (psf), Deflection (deg). Shows 1 load with intensity of 250.0 psf and deflection of 0.0 deg.

NOTE - Intensity Is Specified As A Uniformly Distributed Force Acting On A Horizontally Projected Surface.
A Critical Failure Surface Searching Method, Using A Random Technique For Generating Circular Surfaces, Has Been Specified.
5000 Trial Surfaces Have Been Generated.
250 Surface(s) Initiate(s) From Each Of 20 Points Equally Spaced Along The Ground Surface Between X = 124.40(ft) and X = 124.40(ft)
Each Surface Terminates Between X = 220.00(ft) and X = 270.00(ft)

Unless Further Limitations Were Imposed, The Minimum Elevation At Which A Surface Extends Is Y = 0.00(ft)
5.00(ft) Line Segments Define Each Trial Failure Surface.
Following Are Displayed The Ten Most Critical Of The Trial Failure Surfaces Evaluated. They Are Ordered - Most Critical First.

\* \* Safety Factors Are Calculated By The Modified Bishop Method \* \*
Total Number of Trial Surfaces Attempted = 5000
Number of Trial Surfaces With Valid FS = 5000
Statistical Data On All Valid FS Values:
FS Max = 3.424 FS Min = 1.897 FS Ave = 2.703
Standard Deviation = 0.431 Coefficient of Variation = 15.94 %

Failure Surface Specified By 24 Coordinate Points

Table with 3 columns: Point No., X-Surf (ft), Y-Surf (ft). Lists 24 coordinate points for a failure surface. Below the table, it states: Circle Center At X = 85.127 ; Y = 276.569 ; and Radius = 252.838

Factor of Safety
\*\*\* 1.897 \*\*\*

Table with 10 columns: Slice No., Width (ft), Weight (lbs), Water Force Top (lbs), Water Force Bot (lbs), Tie Force Norm (lbs), Tie Force Tan (lbs), Earthquake Force Hor (lbs), Earthquake Force Ver (lbs), Earthquake Surcharge Load (lbs). Shows data for 7 slices.



8	2.2	931.2	0.0	0.0	0.	0.	0.0	0.0	0.0
9	4.8	2293.6	0.0	0.0	0.	0.	0.0	0.0	0.0
10	1.5	787.1	0.0	0.0	0.	0.	0.0	0.0	0.0
11	2.5	1397.1	0.0	0.0	0.	0.	0.0	0.0	0.0
12	0.2	144.3	0.0	0.0	0.	0.	0.0	0.0	0.0
13	0.2	135.1	0.0	0.0	0.	0.	0.0	0.0	0.0
14	0.3	212.3	0.0	0.0	0.	0.	0.0	0.0	0.0
15	4.7	3290.7	0.0	0.0	0.	0.	0.0	0.0	0.0
16	4.7	3853.7	0.0	0.0	0.	0.	0.0	0.0	0.0
17	4.7	4344.1	0.0	0.0	0.	0.	0.0	0.0	0.0
18	4.6	4762.6	0.0	0.0	0.	0.	0.0	0.0	0.0
19	4.6	5109.8	0.0	0.0	0.	0.	0.0	0.0	0.0
20	4.3	5052.3	0.0	0.0	0.	0.	0.0	0.0	0.0
21	0.3	332.2	0.0	0.0	0.	0.	0.0	0.0	0.0
22	4.5	4913.6	0.0	0.0	0.	0.	0.0	0.0	0.0
23	4.5	3863.9	0.0	0.0	0.	0.	0.0	0.0	0.0
24	4.4	2783.8	0.0	0.0	0.	0.	0.0	0.0	0.0
25	0.4	199.2	0.0	0.0	0.	0.	0.0	0.0	0.0
26	4.0	1973.5	0.0	0.0	0.	0.	0.0	0.0	0.0
27	4.3	2213.5	0.0	0.0	0.	0.	0.0	0.0	0.0
28	4.3	2197.8	0.0	0.0	0.	0.	0.0	0.0	0.0
29	4.2	2122.7	0.0	0.0	0.	0.	0.0	0.0	0.0
30	2.1	1000.5	0.0	0.0	0.	0.	0.0	0.0	0.0
31	2.1	832.3	0.0	0.0	0.	0.	0.0	0.0	0.0
32	3.0	565.1	0.0	0.0	0.	0.	0.0	0.0	0.0
33	0.8	27.8	0.0	0.0	0.	0.	0.0	206.2	0.0

Failure Surface Specified By 24 Coordinate Points

Point No.	X-Surf (ft)	Y-Surf (ft)
1	124.400	26.800
2	129.331	27.626
3	134.245	28.548
4	139.140	29.568
5	144.014	30.685
6	148.865	31.897
7	153.691	33.206
8	158.490	34.609
9	163.260	36.107
10	168.000	37.699
11	172.707	39.384
12	177.380	41.162
13	182.017	43.033
14	186.617	44.994
15	191.176	47.046
16	195.694	49.188
17	200.169	51.418
18	204.599	53.737
19	208.982	56.143
20	213.317	58.635
21	217.601	61.212
22	221.834	63.873
23	226.014	66.618
24	229.825	69.230

Circle Center At X = 85.127 ; Y = 276.569 ; and Radius = 252.838

Factor of Safety

\*\*\* 1.897 \*\*\*

Failure Surface Specified By 24 Coordinate Points

Point No.	X-Surf (ft)	Y-Surf (ft)
1	124.400	26.800
2	129.331	27.626
3	134.245	28.548
4	139.140	29.568
5	144.014	30.685
6	148.865	31.897
7	153.691	33.206
8	158.490	34.609
9	163.260	36.107
10	168.000	37.699
11	172.707	39.384

12	177.380	41.162
13	182.017	43.033
14	186.617	44.994
15	191.176	47.046
16	195.694	49.188
17	200.169	51.418
18	204.599	53.737
19	208.982	56.143
20	213.317	58.635
21	217.601	61.212
22	221.834	63.873
23	226.014	66.618
24	229.825	69.230

Circle Center At X = 85.127 ; Y = 276.569 ; and Radius = 252.838

Factor of Safety

\*\*\* 1.897 \*\*\*

Failure Surface Specified By 25 Coordinate Points

Point No.	X-Surf (ft)	Y-Surf (ft)
1	124.400	26.800
2	129.329	27.638
3	134.242	28.570
4	139.135	29.596
5	144.008	30.717
6	148.859	31.930
7	153.685	33.237
8	158.485	34.636
9	163.258	36.127
10	168.001	37.709
11	172.712	39.382
12	177.391	41.146
13	182.035	42.999
14	186.643	44.940
15	191.212	46.970
16	195.742	49.087
17	200.230	51.291
18	204.675	53.581
19	209.075	55.956
20	213.429	58.414
21	217.734	60.956
22	221.990	63.580
23	226.195	66.285
24	230.348	69.071
25	230.580	69.234

Circle Center At X = 83.250 ; Y = 283.846 ; and Radius = 260.319

Factor of Safety

\*\*\* 1.897 \*\*\*

Failure Surface Specified By 25 Coordinate Points

Point No.	X-Surf (ft)	Y-Surf (ft)
1	124.400	26.800
2	129.329	27.638
3	134.242	28.570
4	139.135	29.596
5	144.008	30.717
6	148.859	31.930
7	153.685	33.237
8	158.485	34.636
9	163.258	36.127
10	168.001	37.709
11	172.712	39.382
12	177.391	41.146
13	182.035	42.999
14	186.643	44.940
15	191.212	46.970
16	195.742	49.087
17	200.230	51.291
18	204.675	53.581
19	209.075	55.956
20	213.429	58.414

21	217.734	60.956
22	221.990	63.580
23	226.195	66.285
24	230.348	69.071
25	230.580	69.234

Circle Center At X = 83.250 ; Y = 283.846 ; and Radius = 260.319  
 Factor of Safety  
 \*\*\* 1.897 \*\*\*

Failure Surface Specified By 24 Coordinate Points

Point No.	X-Surf (ft)	Y-Surf (ft)
1	124.400	26.800
2	129.356	27.465
3	134.295	28.249
4	139.214	29.137
5	144.111	30.149
6	148.982	31.276
7	153.825	32.519
8	158.637	33.877
9	163.416	35.347
10	168.158	36.931
11	172.862	38.627
12	177.524	40.433
13	182.143	42.349
14	186.714	44.375
15	191.236	46.508
16	195.707	48.747
17	200.123	51.092
18	204.482	53.541
19	208.782	56.092
20	213.020	58.745
21	217.195	61.497
22	221.303	64.347
23	225.342	67.294
24	227.855	69.220

Circle Center At X = 98.993 ; Y = 236.127 ; and Radius = 210.864  
 Factor of Safety  
 \*\*\* 1.904 \*\*\*

Failure Surface Specified By 24 Coordinate Points

Point No.	X-Surf (ft)	Y-Surf (ft)
1	124.400	26.800
2	129.356	27.462
3	134.295	28.241
4	139.214	29.137
5	144.111	30.149
6	148.982	31.276
7	153.825	32.519
8	158.637	33.877
9	163.416	35.347
10	168.158	36.931
11	172.862	38.627
12	177.524	40.433
13	182.143	42.349
14	186.714	44.375
15	191.236	46.508
16	195.707	48.747
17	200.123	51.092
18	204.482	53.541
19	208.782	56.092
20	213.020	58.745
21	217.195	61.497
22	221.303	64.347
23	225.342	67.294
24	227.855	69.220

Circle Center At X = 98.993 ; Y = 236.127 ; and Radius = 210.864  
 Factor of Safety  
 \*\*\* 1.904 \*\*\*

Failure Surface Specified By 24 Coordinate Points

Point	X-Surf	Y-Surf
-------	--------	--------

No.	(ft)	(ft)
1	124.400	26.800
2	129.356	27.465
3	134.294	28.249
4	139.212	29.152
5	144.106	30.173
6	148.975	31.311
7	153.815	32.567
8	158.623	33.939
9	163.396	35.427
10	168.133	37.029
11	172.829	38.745
12	177.483	40.573
13	182.091	42.513
14	186.651	44.564
15	191.160	46.724
16	195.617	48.992
17	200.017	51.366
18	204.358	53.846
19	208.639	56.430
20	212.856	59.117
21	217.007	61.904
22	221.090	64.790
23	225.102	67.774
24	226.945	69.215

Circle Center At X = 99.348 ; Y = 232.532 ; and Radius = 207.252  
 Factor of Safety  
 \*\*\* 1.914 \*\*\*

Failure Surface Specified By 24 Coordinate Points

Point No.	X-Surf (ft)	Y-Surf (ft)
1	124.400	26.800
2	129.356	27.465
3	134.294	28.249
4	139.212	29.152
5	144.106	30.173
6	148.975	31.311
7	153.815	32.567
8	158.623	33.939
9	163.396	35.427
10	168.133	37.029
11	172.829	38.745
12	177.483	40.573
13	182.091	42.513
14	186.651	44.564
15	191.160	46.724
16	195.617	48.992
17	200.017	51.366
18	204.358	53.846
19	208.639	56.430
20	212.856	59.117
21	217.007	61.904
22	221.090	64.790
23	225.102	67.774
24	226.945	69.215

Circle Center At X = 99.348 ; Y = 232.532 ; and Radius = 207.252  
 Factor of Safety  
 \*\*\* 1.914 \*\*\*

Failure Surface Specified By 24 Coordinate Points

Point No.	X-Surf (ft)	Y-Surf (ft)
1	124.400	26.800
2	129.321	27.684
3	134.225	28.661
4	139.109	29.731
5	143.972	30.894
6	148.812	32.149
7	153.627	33.497
8	158.415	34.935
9	163.176	36.465

10	167.906	38.084
11	172.605	39.794
12	177.270	41.592
13	181.900	43.479
14	186.494	45.454
15	191.049	47.516
16	195.564	49.664
17	200.037	51.898
18	204.467	54.216
19	208.853	56.618
20	213.191	59.103
21	217.482	61.671
22	221.723	64.319
23	225.913	67.048
24	229.122	69.226

Circle Center At X = 80.470 ; Y = 285.692 ; and Radius = 262.592  
Factor of Safety  
\*\*\* 1.925 \*\*\*  
\*\*\*\* END OF GSTABL7 OUTPUT \*\*\*\*

# 12091-01 / John S. Gibson / Sec. C-C' / Seismic / Keyway 20'

z:\2012\12091-01 howard industrial partners - john s gibson blvd\engineering\slope stability\sections\c-c'\cxl2e.pl2 Run By: SHH 3/14/2019 12:31PM

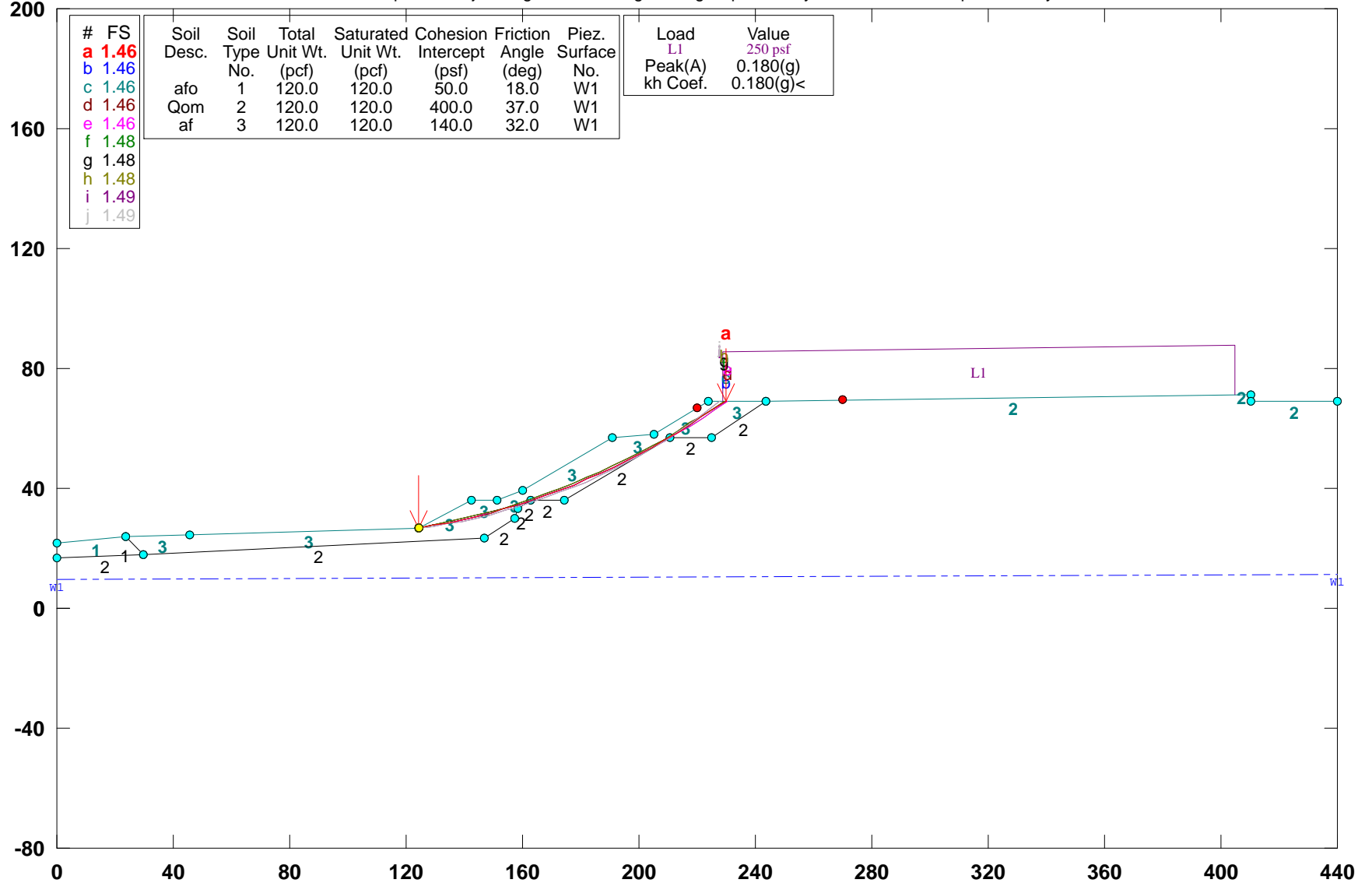

GSTABL7 v.2 FSmin=1.46  
Safety Factors Are Calculated By The Modified Bishop Method

\*\*\* GSTABL7 \*\*\*

\*\* GSTABL7 by Dr. Garry H. Gregory, Ph.D., P.E., D.GE \*\*

\*\* Original Version 1.0, January 1996; Current Ver. 2.005.3, Feb. 2013 \*\*  
 (All Rights Reserved-Unauthorized Use Prohibited)

\*\*\*\*\*

SLOPE STABILITY ANALYSIS SYSTEM

Modified Bishop, Simplified Janbu, or GLE Method of Slices.  
 (Includes Spencer & Morgenstern-Price Type Analysis)  
 Including Pier/Pile, Reinforcement, Soil Nail, Tieback,  
 Nonlinear Undrained Shear Strength, Curved Phi Envelope,  
 Anisotropic Soil, Fiber-Reinforced Soil, Boundary Loads, Water  
 Surfaces, Pseudo-Static & Newmark Earthquake, and Applied Forces.

\*\*\*\*\*

Analysis Run Date: 3/14/2019

Time of Run: 12:31PM

Run By: SHH

Input Data Filename: z:\2012\12091-01 Howard Industrial Partners - John S Gibson

Blvd\Engineering\Slope Stability\Sections\C-C'\cx12e.in

Output Filename: z:\2012\12091-01 Howard Industrial Partners - John S Gibson

Blvd\Engineering\Slope Stability\Sections\C-C'\cx12e.OUT

Unit System: English

Plotted Output Filename: z:\2012\12091-01 Howard Industrial Partners - John S Gibson

Blvd\Engineering\Slope Stability\Sections\C-C'\cx12e.PLT

PROBLEM DESCRIPTION: 12091-01 / John S. Gibson / Sec. C-C' /  
 Seismic / Keyway 20'

BOUNDARY COORDINATES

13 Top Boundaries

23 Total Boundaries

Boundary No.	X-Left (ft)	Y-Left (ft)	X-Right (ft)	Y-Right (ft)	Soil Type Below Bnd
1	0.00	22.00	23.90	23.80	1
2	23.90	23.80	45.70	24.40	3
3	45.70	24.40	124.40	26.80	3
4	124.40	26.80	142.70	36.00	3
5	142.70	36.00	151.50	36.00	3
6	151.50	36.00	160.00	39.50	3
7	160.00	39.50	190.90	57.00	3
8	190.90	57.00	205.00	58.00	3
9	205.00	58.00	223.90	69.20	3
10	223.90	69.20	243.70	69.30	3
11	243.70	69.30	410.50	71.30	2
12	410.50	71.30	410.51	69.00	2
13	410.51	69.00	440.00	69.00	2
14	23.90	23.80	29.60	18.10	1
15	29.60	18.10	146.60	23.30	2
16	146.60	23.30	157.50	30.10	2
17	157.50	30.10	158.40	33.40	2
18	158.40	33.40	162.70	36.00	2
19	162.70	36.00	174.40	36.00	2
20	174.40	36.00	210.90	57.00	2
21	210.90	57.00	225.00	57.10	2
22	225.00	57.10	243.70	69.30	2
23	0.00	16.80	29.60	18.10	2

Default Y-Origin = 0.00(ft)

Default X-Plus Value = 0.00(ft)

Default Y-Plus Value = 0.00(ft)

ISOTROPIC SOIL PARAMETERS

3 Type(s) of Soil

Soil Type No.	Total Unit Wt. (pcf)	Saturated Unit Wt. (pcf)	Cohesion (psf)	Friction Angle (deg)	Pore Pressure Param. (psf)	Pressure Constant (psf)	Piez. Surface No.
1	120.0	120.0	50.0	18.0	0.00	0.0	1
2	120.0	120.0	400.0	37.0	0.00	0.0	1
3	120.0	120.0	140.0	32.0	0.00	0.0	1

1 PIEZOMETRIC SURFACE(S) SPECIFIED

Unit Weight of Water = 62.40 (pcf)

Piezometric Surface No. 1 Specified by 2 Coordinate Points

Pore Pressure Inclination Factor = 0.50

Point No.	X-Water (ft)	Y-Water (ft)
1		
2		

1	0.00	9.80
2	440.00	11.50

BOUNDARY LOAD(S)

1 Load(s) Specified

Load No.	X-Left (ft)	X-Right (ft)	Intensity (psf)	Deflection (deg)
1	229.00	405.00	250.0	0.0

NOTE - Intensity Is Specified As A Uniformly Distributed

Force Acting On A Horizontally Projected Surface.

Specified Peak Ground Acceleration Coefficient (A) = 0.180(g)

Specified Horizontal Earthquake Coefficient (kh) = 0.180(g)

Specified Vertical Earthquake Coefficient (kv) = 0.000(g)

Specified Seismic Pore-Pressure Factor = 0.000

A Critical Failure Surface Searching Method, Using A Random

Technique For Generating Circular Surfaces, Has Been Specified.

5000 Trial Surfaces Have Been Generated.

250 Surface(s) Initiate(s) From Each Of 20 Points Equally Spaced

Along The Ground Surface Between X = 124.40(ft)

and X = 124.40(ft)

Each Surface Terminates Between X = 220.00(ft)

and X = 270.00(ft)

Unless Further Limitations Were Imposed, The Minimum Elevation

At Which A Surface Extends Is Y = 0.00(ft)

5.00(ft) Line Segments Define Each Trial Failure Surface.

Following Are Displayed The Ten Most Critical Of The Trial

Failure Surfaces Evaluated. They Are

Ordered - Most Critical First.

\* \* Safety Factors Are Calculated By The Modified Bishop Method \* \*

Total Number of Trial Surfaces Attempted = 5000

Number of Trial Surfaces With Valid FS = 5000

Statistical Data On All Valid FS Values:

FS Max = 1.846 FS Min = 1.459 FS Ave = 2.263

Standard Deviation = 0.351 Coefficient of Variation = 15.52 %

Failure Surface Specified By 24 Coordinate Points

Point No. X-Surf (ft) Y-Surf (ft)

1	124.400	26.800
2	129.331	27.626
3	134.245	28.548
4	139.140	29.568
5	144.014	30.685
6	148.865	31.897
7	153.691	33.206
8	158.490	34.609
9	163.260	36.107
10	168.000	37.699
11	172.707	39.384
12	177.380	41.162
13	182.017	43.033
14	186.617	44.994
15	191.176	47.046
16	195.694	49.188
17	200.169	51.418
18	204.599	53.737
19	208.982	56.143
20	213.317	58.635
21	217.601	61.212
22	221.834	63.873
23	226.014	66.618
24	229.825	69.230

Circle Center At X = 85.127 ; Y = 276.569 ; and Radius = 252.838

Factor of Safety \*\*\* 1.459 \*\*\*

Slice No.	Width (ft)	Weight (lbs)	Water Force		Tie Force		Earthquake Force		Surcharge (lbs)
			Top (lbs)	Bot (lbs)	Norm (lbs)	Tan (lbs)	Hor (lbs)	Ver (lbs)	
1	4.9	489.3	0.0	0.0	0.0	0.0	88.1	0.0	0.0
2	4.9	1431.4	0.0	0.0	0.0	0.0	257.7	0.0	0.0

3	4.9	2303.5	0.0	0.0	0.	0.	414.6	0.0	0.0
4	3.6	2191.0	0.0	0.0	0.	0.	394.4	0.0	0.0
5	1.3	861.9	0.0	0.0	0.	0.	155.1	0.0	0.0
6	4.9	2741.0	0.0	0.0	0.	0.	493.4	0.0	0.0
7	2.6	1184.4	0.0	0.0	0.	0.	213.2	0.0	0.0
8	2.2	931.2	0.0	0.0	0.	0.	167.6	0.0	0.0
9	4.8	2293.6	0.0	0.0	0.	0.	412.9	0.0	0.0
10	1.5	787.1	0.0	0.0	0.	0.	141.7	0.0	0.0
11	2.5	1397.1	0.0	0.0	0.	0.	251.5	0.0	0.0
12	0.2	144.3	0.0	0.0	0.	0.	26.0	0.0	0.0
13	0.2	135.1	0.0	0.0	0.	0.	24.3	0.0	0.0
14	0.3	212.3	0.0	0.0	0.	0.	38.2	0.0	0.0
15	4.7	3290.7	0.0	0.0	0.	0.	592.3	0.0	0.0
16	4.7	3853.7	0.0	0.0	0.	0.	693.7	0.0	0.0
17	4.7	4344.1	0.0	0.0	0.	0.	781.9	0.0	0.0
18	4.6	4762.6	0.0	0.0	0.	0.	857.3	0.0	0.0
19	4.6	5109.8	0.0	0.0	0.	0.	919.8	0.0	0.0
20	4.3	5052.3	0.0	0.0	0.	0.	909.4	0.0	0.0
21	0.3	332.2	0.0	0.0	0.	0.	59.8	0.0	0.0
22	4.5	4913.6	0.0	0.0	0.	0.	884.5	0.0	0.0
23	4.5	3863.9	0.0	0.0	0.	0.	695.5	0.0	0.0
24	4.4	2783.8	0.0	0.0	0.	0.	501.1	0.0	0.0
25	0.4	199.2	0.0	0.0	0.	0.	35.9	0.0	0.0
26	4.0	1973.5	0.0	0.0	0.	0.	355.2	0.0	0.0
27	4.3	2213.5	0.0	0.0	0.	0.	398.4	0.0	0.0
28	4.3	2197.8	0.0	0.0	0.	0.	395.6	0.0	0.0
29	4.2	2122.7	0.0	0.0	0.	0.	382.1	0.0	0.0
30	2.1	1000.5	0.0	0.0	0.	0.	180.1	0.0	0.0
31	2.1	832.3	0.0	0.0	0.	0.	149.8	0.0	0.0
32	3.0	565.1	0.0	0.0	0.	0.	101.7	0.0	0.0
33	0.8	27.8	0.0	0.0	0.	0.	5.0	0.0	206.2

Failure Surface Specified By 24 Coordinate Points

Point No.	X-Surf (ft)	Y-Surf (ft)
1	124.400	26.800
2	129.331	27.626
3	134.245	28.548
4	139.140	29.568
5	144.014	30.685
6	148.865	31.897
7	153.691	33.206
8	158.490	34.609
9	163.260	36.107
10	168.000	37.699
11	172.707	39.384
12	177.380	41.162
13	182.017	43.033
14	186.617	44.994
15	191.176	47.046
16	195.694	49.188
17	200.169	51.418
18	204.599	53.737
19	208.982	56.143
20	213.317	58.635
21	217.601	61.212
22	221.834	63.873
23	226.014	66.618
24	229.825	69.230

Circle Center At X = 85.127 ; Y = 276.569 ; and Radius = 252.838

Factor of Safety  
\*\*\* 1.459 \*\*\*

Failure Surface Specified By 24 Coordinate Points

Point No.	X-Surf (ft)	Y-Surf (ft)
1	124.400	26.800
2	129.331	27.626
3	134.245	28.548
4	139.140	29.568
5	144.014	30.685
6	148.865	31.897

7	153.691	33.206
8	158.490	34.609
9	163.260	36.107
10	168.000	37.699
11	172.707	39.384
12	177.380	41.162
13	182.017	43.033
14	186.617	44.994
15	191.176	47.046
16	195.694	49.188
17	200.169	51.418
18	204.599	53.737
19	208.982	56.143
20	213.317	58.635
21	217.601	61.212
22	221.834	63.873
23	226.014	66.618
24	229.825	69.230

Circle Center At X = 85.127 ; Y = 276.569 ; and Radius = 252.838

Factor of Safety  
\*\*\* 1.459 \*\*\*

Failure Surface Specified By 25 Coordinate Points

Point No.	X-Surf (ft)	Y-Surf (ft)
1	124.400	26.800
2	129.329	27.638
3	134.242	28.570
4	139.135	29.596
5	144.008	30.717
6	148.859	31.930
7	153.685	33.237
8	158.485	34.636
9	163.258	36.127
10	168.001	37.709
11	172.712	39.382
12	177.391	41.146
13	182.035	42.999
14	186.643	44.940
15	191.212	46.970
16	195.742	49.087
17	200.230	51.291
18	204.675	53.581
19	209.075	55.956
20	213.429	58.414
21	217.734	60.956
22	221.990	63.580
23	226.195	66.285
24	230.348	69.071
25	230.580	69.234

Circle Center At X = 83.250 ; Y = 283.846 ; and Radius = 260.319

Factor of Safety  
\*\*\* 1.464 \*\*\*

Failure Surface Specified By 25 Coordinate Points

Point No.	X-Surf (ft)	Y-Surf (ft)
1	124.400	26.800
2	129.329	27.638
3	134.242	28.570
4	139.135	29.596
5	144.008	30.717
6	148.859	31.930
7	153.685	33.237
8	158.485	34.636
9	163.258	36.127
10	168.001	37.709
11	172.712	39.382
12	177.391	41.146
13	182.035	42.999
14	186.643	44.940
15	191.212	46.970

16 195.742 49.087  
 17 200.230 51.291  
 18 204.675 53.581  
 19 209.075 55.956  
 20 213.429 58.414  
 21 217.734 60.956  
 22 221.990 63.580  
 23 226.195 66.285  
 24 230.348 69.071  
 25 230.580 69.234

Circle Center At X = 83.250 ; Y = 283.846 ; and Radius = 260.319  
 Factor of Safety  
 \*\*\* 1.464 \*\*\*

## Failure Surface Specified By 24 Coordinate Points

Point No.	X-Surf (ft)	Y-Surf (ft)
1	124.400	26.800
2	129.321	27.684
3	134.225	28.661
4	139.109	29.731
5	143.972	30.894
6	148.812	32.149
7	153.627	33.497
8	158.415	34.935
9	163.176	36.465
10	167.906	38.084
11	172.605	39.794
12	177.270	41.592
13	181.900	43.479
14	186.494	45.454
15	191.049	47.516
16	195.564	49.664
17	200.037	51.898
18	204.467	54.216
19	208.853	56.618
20	213.191	59.103
21	217.482	61.671
22	221.723	64.319
23	225.913	67.048
24	229.122	69.226

Circle Center At X = 80.470 ; Y = 285.692 ; and Radius = 262.592  
 Factor of Safety  
 \*\*\* 1.483 \*\*\*

## Failure Surface Specified By 24 Coordinate Points

Point No.	X-Surf (ft)	Y-Surf (ft)
1	124.400	26.800
2	129.321	27.684
3	134.225	28.661
4	139.109	29.731
5	143.972	30.894
6	148.812	32.149
7	153.627	33.497
8	158.415	34.935
9	163.176	36.465
10	167.906	38.084
11	172.605	39.794
12	177.270	41.592
13	181.900	43.479
14	186.494	45.454
15	191.049	47.516
16	195.564	49.664
17	200.037	51.898
18	204.467	54.216
19	208.853	56.618
20	213.191	59.103
21	217.482	61.671
22	221.723	64.319
23	225.913	67.048
24	229.122	69.226

Circle Center At X = 80.470 ; Y = 285.692 ; and Radius = 262.592

Factor of Safety  
 \*\*\* 1.483 \*\*\*

## Failure Surface Specified By 24 Coordinate Points

Point No.	X-Surf (ft)	Y-Surf (ft)
1	124.400	26.800
2	129.321	27.684
3	134.225	28.661
4	139.109	29.731
5	143.972	30.894
6	148.812	32.149
7	153.627	33.497
8	158.415	34.935
9	163.176	36.465
10	167.906	38.084
11	172.605	39.794
12	177.270	41.592
13	181.900	43.479
14	186.494	45.454
15	191.049	47.516
16	195.564	49.664
17	200.037	51.898
18	204.467	54.216
19	208.853	56.618
20	213.191	59.103
21	217.482	61.671
22	221.723	64.319
23	225.913	67.048
24	229.122	69.226

Circle Center At X = 80.470 ; Y = 285.692 ; and Radius = 262.592  
 Factor of Safety  
 \*\*\* 1.483 \*\*\*

## Failure Surface Specified By 24 Coordinate Points

Point No.	X-Surf (ft)	Y-Surf (ft)
1	124.400	26.800
2	129.356	27.462
3	134.295	28.241
4	139.214	29.137
5	144.111	30.149
6	148.982	31.276
7	153.825	32.519
8	158.637	33.877
9	163.416	35.347
10	168.158	36.931
11	172.862	38.627
12	177.524	40.433
13	182.143	42.349
14	186.714	44.375
15	191.236	46.508
16	195.707	48.747
17	200.123	51.092
18	204.482	53.541
19	208.782	56.092
20	213.020	58.745
21	217.195	61.497
22	221.303	64.347
23	225.342	67.294
24	227.855	69.220

Circle Center At X = 98.993 ; Y = 236.127 ; and Radius = 210.864  
 Factor of Safety  
 \*\*\* 1.485 \*\*\*

## Failure Surface Specified By 24 Coordinate Points

Point No.	X-Surf (ft)	Y-Surf (ft)
1	124.400	26.800
2	129.356	27.462
3	134.295	28.241
4	139.214	29.137

5	144.111	30.149
6	148.982	31.276
7	153.825	32.519
8	158.637	33.877
9	163.416	35.347
10	168.158	36.931
11	172.862	38.627
12	177.524	40.433
13	182.143	42.349
14	186.714	44.375
15	191.236	46.508
16	195.707	48.747
17	200.123	51.092
18	204.482	53.541
19	208.782	56.092
20	213.020	58.745
21	217.195	61.497
22	221.303	64.347
23	225.342	67.294
24	227.855	69.220

Circle Center At X = 98.993 ; Y = 236.127 ; and Radius = 210.864  
Factor of Safety  
\*\*\* 1.485 \*\*\*  
\*\*\*\* END OF GSTABL7 OUTPUT \*\*\*\*



# 12091-01 / John S. Gibson / Sec. D-D' MSE Wall "C" / Static

z:\2012\12091-01 howard industrial partners - john s gibson blvd\engineering\slope stability\sections\d-d'\dxl.pl2 Run By: SHH 3/14/2019 12:33PM

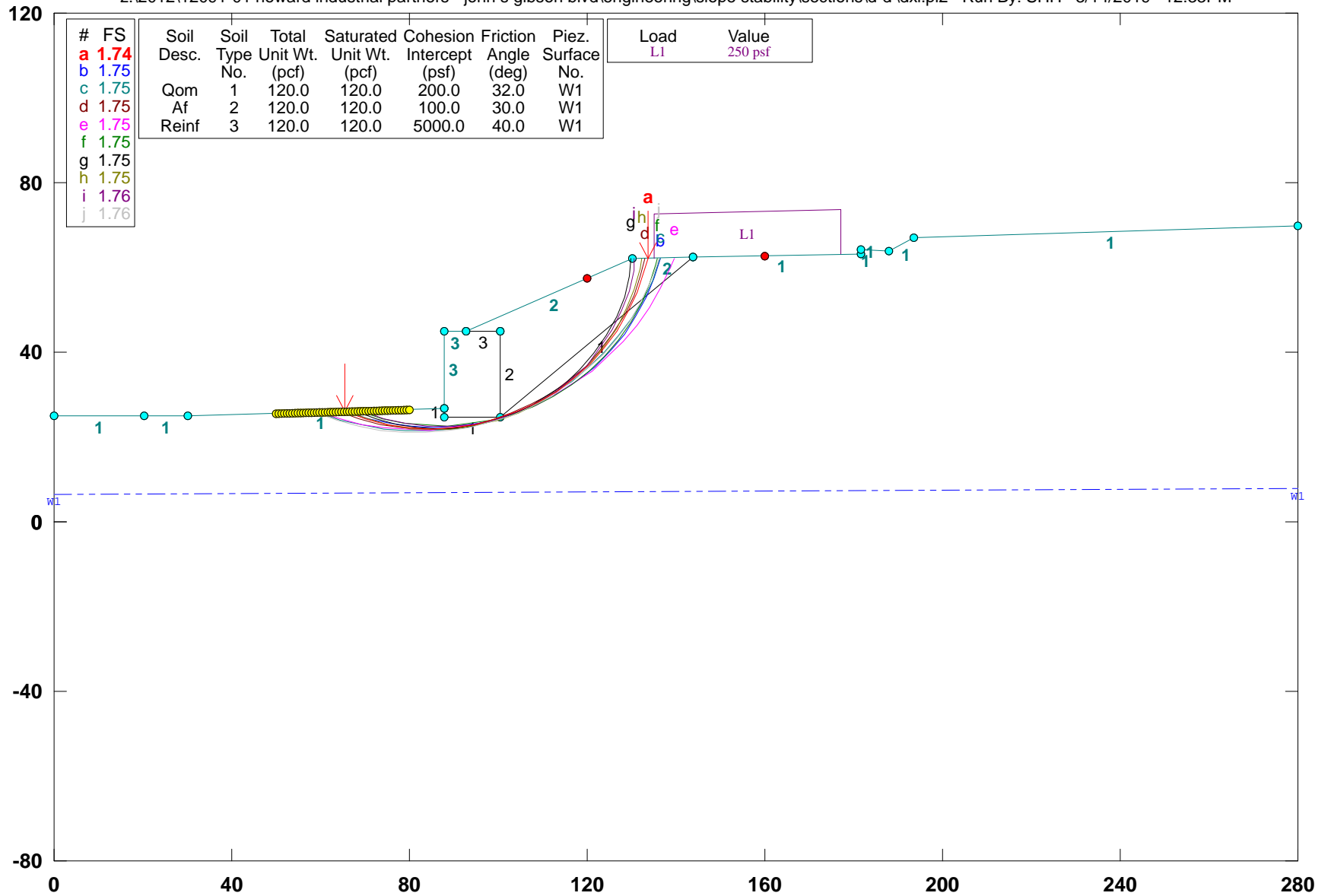

GSTABL7 v.2 FSmin=1.74  
 Safety Factors Are Calculated By The Modified Bishop Method

\*\*\* GSTABL7 \*\*\*

\*\* GSTABL7 by Dr. Garry H. Gregory, Ph.D., P.E., D.GE \*\*

\*\* Original Version 1.0, January 1996; Current Ver. 2.005.3, Feb. 2013 \*\*  
(All Rights Reserved-Unauthorized Use Prohibited)

SLOPE STABILITY ANALYSIS SYSTEM

Modified Bishop, Simplified Janbu, or GLE Method of Slices.  
(Includes Spencer & Morgenstern-Price Type Analysis)  
Including Pier/Pile, Reinforcement, Soil Nail, Tieback,  
Nonlinear Undrained Shear Strength, Curved Phi Envelope,  
Anisotropic Soil, Fiber-Reinforced Soil, Boundary Loads, Water  
Surfaces, Pseudo-Static & Newmark Earthquake, and Applied Forces.

Analysis Run Date: 3/14/2019  
Time of Run: 12:33PM  
Run By: SHH

Input Data Filename: z:\2012\12091-01 Howard Industrial Partners - John S Gibson  
Blvd\Engineering\Slope Stability\Sections\D-D'\dxl.in  
Output Filename: z:\2012\12091-01 Howard Industrial Partners - John S Gibson  
Blvd\Engineering\Slope Stability\Sections\D-D'\dxl.OUT  
Unit System: English  
Plotted Output Filename: z:\2012\12091-01 Howard Industrial Partners - John S Gibson  
Blvd\Engineering\Slope Stability\Sections\D-D'\dxl.PLT  
PROBLEM DESCRIPTION: 12091-01 / John S. Gibson / Sec. D-D'  
MSE Wall "C" / Static

BOUNDARY COORDINATES

Boundary No.	X-Left (ft)	Y-Left (ft)	X-Right (ft)	Y-Right (ft)	Soil Type Below Bnd
1	0.00	24.90	20.30	24.90	1
2	20.30	24.90	30.20	24.90	1
3	30.20	24.90	87.70	26.60	1
4	87.70	26.60	87.71	45.00	3
5	87.71	45.00	92.60	45.00	3
6	92.60	45.00	130.10	62.00	2
7	130.10	62.00	143.80	62.30	2
8	143.80	62.30	181.80	63.10	1
9	181.80	63.10	181.81	64.10	1
10	181.81	64.10	187.80	64.00	1
11	187.80	64.00	193.60	67.00	1
12	193.60	67.00	280.00	69.70	1
13	92.60	45.00	100.58	45.00	3
14	87.70	26.60	87.72	24.60	1
15	87.72	24.60	100.57	24.60	1
16	100.57	24.60	100.58	45.00	2
17	100.57	24.60	143.80	62.30	1

Default Y-Origin = 0.00(ft)  
Default X-Plus Value = 0.00(ft)  
Default Y-Plus Value = 0.00(ft)

ISOTROPIC SOIL PARAMETERS

Soil Type No.	Total Unit Wt. (pcf)	Saturated Unit Wt. (pcf)	Cohesion (psf)	Friction Angle (deg)	Pore Pressure Param. (psf)	Piez. Surface No.
1	120.0	120.0	200.0	32.0	0.00	1
2	120.0	120.0	100.0	30.0	0.00	1
3	120.0	120.0	5000.0	40.0	0.00	1

1 PIEZOMETRIC SURFACE(S) SPECIFIED

Unit Weight of Water = 62.40 (pcf)  
Piezometric Surface No. 1 Specified by 2 Coordinate Points  
Pore Pressure Inclination Factor = 0.50

Point No.	X-Water (ft)	Y-Water (ft)
1	0.00	6.30
2	280.00	8.00

BOUNDARY LOAD(S)

Load No.	X-Left (ft)	X-Right (ft)	Intensity (psf)	Deflection (deg)
1				

1 135.00 177.00 250.0 0.0

NOTE - Intensity Is Specified As A Uniformly Distributed

Force Acting On A Horizontally Projected Surface.  
A Critical Failure Surface Searching Method, Using A Random  
Technique For Generating Circular Surfaces, Has Been Specified.  
5000 Trial Surfaces Have Been Generated.

100 Surface(s) Initiate(s) From Each Of 50 Points Equally Spaced  
Along The Ground Surface Between X = 50.00(ft)  
and X = 80.00(ft)  
Each Surface Terminates Between X = 120.00(ft)  
and X = 160.00(ft)

Unless Further Limitations Were Imposed, The Minimum Elevation  
At Which A Surface Extends Is Y = 0.00(ft)  
5.00(ft) Line Segments Define Each Trial Failure Surface.  
Following Are Displayed The Ten Most Critical Of The Trial

Failure Surfaces Evaluated. They Are  
Ordered - Most Critical First.  
\* \* Safety Factors Are Calculated By The Modified Bishop Method \* \*  
Total Number of Trial Surfaces Attempted = 5000  
Number of Trial Surfaces With Valid FS = 5000  
Statistical Data on All Valid FS Values:  
FS Max = 3.772 FS Min = 1.739 FS Ave = 2.406  
Standard Deviation = 0.335 Coefficient of Variation = 13.93 %  
Failure Surface Specified By 19 Coordinate Points

Point No.	X-Surf (ft)	Y-Surf (ft)
1	65.306	25.938
2	69.998	24.210
3	74.840	22.962
4	79.782	22.207
5	84.776	21.952
6	89.770	22.200
7	94.714	22.948
8	99.557	24.189
9	104.252	25.910
10	108.749	28.094
11	113.005	30.718
12	116.976	33.757
13	120.621	37.179
14	123.905	40.950
15	126.793	45.031
16	129.256	49.383
17	131.270	53.959
18	132.814	58.715
19	133.542	62.075

Circle Center At X = 84.812 ; Y = 71.672 ; and Radius = 49.720

Factor of Safety = 1.739

Individual data on the 26 slices

Slice No.	Width (ft)	Weight (lbs)	Water Force Top (lbs)	Water Force Bot (lbs)	Tie Force Norm (lbs)	Tie Force Tan (lbs)	Earthquake Force Hor (lbs)	Surcharge Force Ver (lbs)	Surcharge Load (lbs)
1	4.7	525.5	0.0	0.0	0.0	0.0	0.0	0.0	0.0
2	4.8	1488.6	0.0	0.0	0.0	0.0	0.0	0.0	0.0
3	4.9	2199.4	0.0	0.0	0.0	0.0	0.0	0.0	0.0
4	5.0	2612.7	0.0	0.0	0.0	0.0	0.0	0.0	0.0
5	2.9	1590.3	0.0	0.0	0.0	0.0	0.0	0.0	0.0
6	0.0	16.5	0.0	0.0	0.0	0.0	0.0	0.0	0.0
7	0.0	27.5	0.0	0.0	0.0	0.0	0.0	0.0	0.0
8	2.0	5620.9	0.0	0.0	0.0	0.0	0.0	0.0	0.0
9	2.8	7670.7	0.0	0.0	0.0	0.0	0.0	0.0	0.0
10	2.1	5755.0	0.0	0.0	0.0	0.0	0.0	0.0	0.0
11	4.8	13651.8	0.0	0.0	0.0	0.0	0.0	0.0	0.0
12	1.0	2918.2	0.0	0.0	0.0	0.0	0.0	0.0	0.0
13	0.0	28.9	0.0	0.0	0.0	0.0	0.0	0.0	0.0
14	3.7	10668.1	0.0	0.0	0.0	0.0	0.0	0.0	0.0
15	4.5	13115.8	0.0	0.0	0.0	0.0	0.0	0.0	0.0
16	4.3	12195.4	0.0	0.0	0.0	0.0	0.0	0.0	0.0
17	4.0	10917.6	0.0	0.0	0.0	0.0	0.0	0.0	0.0

18	3.6	9365.3	0.0	0.0	0.	0.	0.0	0.0	0.0
19	3.3	7636.8	0.0	0.0	0.	0.	0.0	0.0	0.0
20	2.9	5841.3	0.0	0.0	0.	0.	0.0	0.0	0.0
21	2.5	4094.8	0.0	0.0	0.	0.	0.0	0.0	0.0
22	0.2	242.3	0.0	0.0	0.	0.	0.0	0.0	0.0
23	0.7	919.1	0.0	0.0	0.	0.	0.0	0.0	0.0
24	1.2	1317.4	0.0	0.0	0.	0.	0.0	0.0	0.0
25	1.5	1057.2	0.0	0.0	0.	0.	0.0	0.0	0.0
26	0.7	146.1	0.0	0.0	0.	0.	0.0	0.0	0.0

Failure Surface Specified By 19 Coordinate Points

Point No.	X-Surf (ft)	Y-Surf (ft)
1	65.918	25.956
2	70.646	24.329
3	75.507	23.158
4	80.457	22.452
5	85.452	22.218
6	90.446	22.458
7	95.395	23.170
8	100.254	24.347
9	104.980	25.979
10	109.531	28.052
11	113.864	30.546
12	117.942	33.439
13	121.728	36.705
14	125.187	40.315
15	128.289	44.237
16	131.006	48.435
17	133.313	52.871
18	135.189	57.505
19	136.572	62.142

Circle Center At X = 85.420 ; Y = 74.958 ; and Radius = 52.740

Factor of Safety  
\*\*\* 1.745 \*\*\*

Failure Surface Specified By 21 Coordinate Points

Point No.	X-Surf (ft)	Y-Surf (ft)
1	59.796	25.775
2	64.490	24.053
3	69.316	22.747
4	74.239	21.870
5	79.219	21.426
6	84.219	21.420
7	89.200	21.851
8	94.125	22.717
9	98.955	24.010
10	103.653	25.721
11	108.183	27.837
12	112.511	30.341
13	116.603	33.214
14	120.429	36.434
15	123.957	39.976
16	127.162	43.814
17	130.019	47.917
18	132.506	52.255
19	134.604	56.793
20	136.297	61.498
21	136.466	62.139

Circle Center At X = 81.789 ; Y = 78.451 ; and Radius = 57.083

Factor of Safety  
\*\*\* 1.745 \*\*\*

Failure Surface Specified By 19 Coordinate Points

Point No.	X-Surf (ft)	Y-Surf (ft)
1	64.082	25.902
2	68.761	24.139
3	73.593	22.854
4	78.529	22.058
5	83.520	21.760
6	88.516	21.962

7	93.467	22.663
8	98.322	23.855
9	103.035	25.527
10	107.556	27.662
11	111.841	30.238
12	115.847	33.229
13	119.534	36.607
14	122.865	40.336
15	125.806	44.379
16	128.329	48.696
17	130.406	53.244
18	132.019	57.977
19	132.968	62.063

Circle Center At X = 84.001 ; Y = 71.698 ; and Radius = 49.940

Factor of Safety  
\*\*\* 1.749 \*\*\*

Failure Surface Specified By 21 Coordinate Points

Point No.	X-Surf (ft)	Y-Surf (ft)
1	59.796	25.775
2	64.528	24.160
3	69.375	22.934
4	74.306	22.107
5	79.288	21.684
6	84.288	21.667
7	89.273	22.056
8	94.210	22.850
9	99.065	24.043
10	103.808	25.626
11	108.406	27.590
12	112.830	29.921
13	117.049	32.604
14	121.036	35.622
15	124.764	38.953
16	128.209	42.577
17	131.348	46.469
18	134.160	50.603
19	136.627	54.952
20	138.732	59.488
21	139.736	62.211

Circle Center At X = 81.996 ; Y = 83.063 ; and Radius = 61.439

Factor of Safety  
\*\*\* 1.749 \*\*\*

Failure Surface Specified By 19 Coordinate Points

Point No.	X-Surf (ft)	Y-Surf (ft)
1	68.980	26.047
2	73.726	24.475
3	78.606	23.386
4	83.570	22.790
5	88.570	22.694
6	93.553	23.099
7	98.471	24.000
8	103.274	25.389
9	107.915	27.252
10	112.345	29.569
11	116.522	32.318
12	120.402	35.471
13	123.948	38.996
14	127.123	42.858
15	129.896	47.019
16	132.239	51.436
17	134.128	56.065
18	135.545	60.861
19	135.784	62.124

Circle Center At X = 87.025 ; Y = 72.587 ; and Radius = 49.917

Factor of Safety  
\*\*\* 1.751 \*\*\*

Failure Surface Specified By 18 Coordinate Points

Point	X-Surf	Y-Surf
-------	--------	--------

No.	(ft)	(ft)
1	67.755	26.010
2	72.406	24.176
3	77.236	22.881
4	82.181	22.141
5	87.178	21.968
6	92.162	22.362
7	97.070	23.318
8	101.837	24.825
9	106.403	26.863
10	110.709	29.406
11	114.698	32.420
12	118.320	35.867
13	121.527	39.702
14	124.279	43.877
15	126.540	48.337
16	128.281	53.024
17	129.479	57.878
18	130.005	61.957

Circle Center At X = 86.208 ; Y = 65.928 ; and Radius = 43.977  
 Factor of Safety  
 \*\*\* 1.751 \*\*\*

Failure Surface Specified By 19 Coordinate Points

Point	X-Surf	Y-Surf
No.	(ft)	(ft)
1	65.918	25.956
2	70.575	24.136
3	75.399	22.818
4	80.334	22.016
5	85.326	21.740
6	90.320	21.992
7	95.259	22.769
8	100.088	24.064
9	104.754	25.861
10	109.205	28.140
11	113.389	30.877
12	117.262	34.040
13	120.779	37.593
14	123.902	41.499
15	126.594	45.711
16	128.828	50.185
17	130.576	54.869
18	131.821	59.712
19	132.163	62.045

Circle Center At X = 85.442 ; Y = 69.049 ; and Radius = 47.309  
 Factor of Safety  
 \*\*\* 1.754 \*\*\*

Failure Surface Specified By 18 Coordinate Points

Point	X-Surf	Y-Surf
No.	(ft)	(ft)
1	69.592	26.065
2	74.276	24.317
3	79.130	23.115
4	84.089	22.475
5	89.088	22.405
6	94.063	22.905
7	98.949	23.970
8	103.681	25.585
9	108.197	27.729
10	112.440	30.374
11	116.354	33.487
12	119.886	37.025
13	122.993	40.943
14	125.631	45.190
15	127.769	49.710
16	129.376	54.445
17	130.433	59.332
18	130.699	62.013

Circle Center At X = 87.208 ; Y = 66.031 ; and Radius = 43.676  
 Factor of Safety

\*\*\* 1.756 \*\*\*  
 Failure Surface Specified By 21 Coordinate Points

Point	X-Surf	Y-Surf
No.	(ft)	(ft)
1	59.184	25.757
2	63.851	23.963
3	68.658	22.588
4	73.568	21.643
5	78.542	21.135
6	83.542	21.068
7	88.527	21.443
8	93.461	22.257
9	98.303	23.503
10	103.016	25.172
11	107.564	27.250
12	111.910	29.722
13	116.021	32.568
14	119.865	35.765
15	123.411	39.290
16	126.633	43.114
17	129.504	47.207
18	132.002	51.538
19	134.109	56.073
20	135.806	60.776
21	136.164	62.133

Circle Center At X = 81.796 ; Y = 77.615 ; and Radius = 56.574  
 Factor of Safety

\*\*\* 1.758 \*\*\*  
 \*\*\*\*\* END OF GSTABL7 OUTPUT \*\*\*\*\*

# 12091-01 / John S. Gibson / Sec. D-D' MSE Wall "C" / Seismic

z:\2012\12091-01 howard industrial partners - john s gibson blvd\engineering\slope stability\sections\d-d'\dxle.pl2 Run By: SHH 3/14/2019 12:35PM

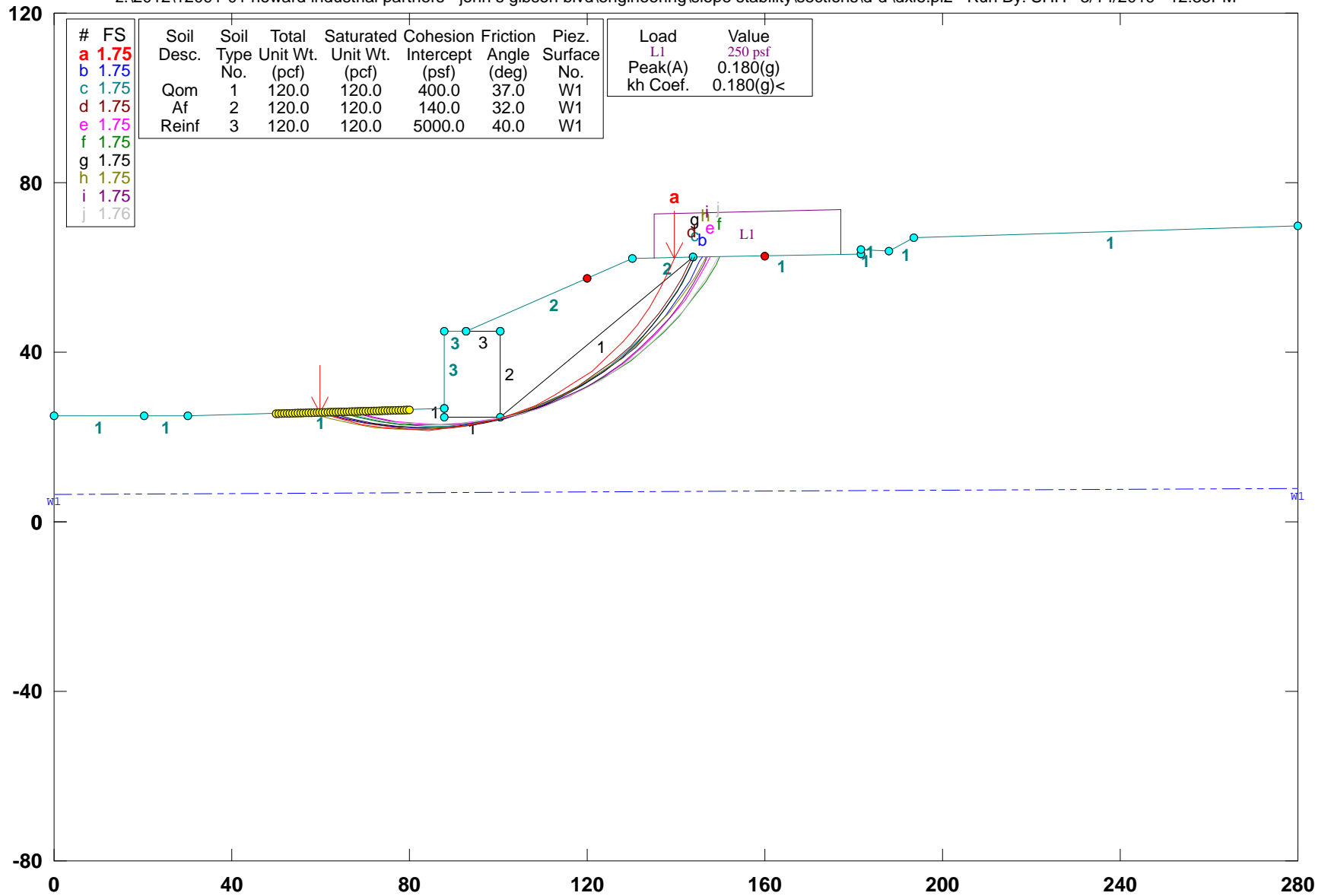

**GSTABL7 v.2 FSmin=1.75**  
**Safety Factors Are Calculated By The Modified Bishop Method**

\*\*\* GSTABL7 \*\*\*

\*\* GSTABL7 by Dr. Garry H. Gregory, Ph.D., P.E., D.GE \*\*

\*\* Original Version 1.0, January 1996; Current Ver. 2.005.3, Feb. 2013 \*\*  
(All Rights Reserved-Unauthorised Use Prohibited)

SLOPE STABILITY ANALYSIS SYSTEM

Modified Bishop, Simplified Janbu, or GLE Method of Slices.  
(Includes Spencer & Morgenstern-Price Type Analysis)  
Including Pier/Pile, Reinforcement, Soil Nail, Tieback,  
Nonlinear Undrained Shear Strength, Curved Phi Envelope,  
Anisotropic Soil, Fiber-Reinforced Soil, Boundary Loads, Water  
Surfaces, Pseudo-Static & Newmark Earthquake, and Applied Forces.

\*\*\*\*\*  
Analysis Run Date: 3/14/2019  
Time of Run: 12:35PM  
Run By: SHH  
Input Data Filename: z:\2012\12091-01 Howard Industrial Partners - John S Gibson  
Blvd\Engineering\Slope Stability\Sections\D-D'\dxle.in  
Output Filename: z:\2012\12091-01 Howard Industrial Partners - John S Gibson  
Blvd\Engineering\Slope Stability\Sections\D-D'\dxle.OUT  
Unit System: English  
Plotted Output Filename: z:\2012\12091-01 Howard Industrial Partners - John S Gibson  
Blvd\Engineering\Slope Stability\Sections\D-D'\dxle.PLT  
PROBLEM DESCRIPTION: 12091-01 / John S. Gibson / Sec. D-D'  
MSE Wall "C" / Seismic

BOUNDARY COORDINATES  
12 Top Boundaries  
17 Total Boundaries

Boundary No.	X-Left (ft)	Y-Left (ft)	X-Right (ft)	Y-Right (ft)	Soil Type Below Bnd
1	0.00	24.90	20.30	24.90	1
2	20.30	24.90	30.20	24.90	1
3	30.20	24.90	87.70	26.60	1
4	87.70	26.60	87.71	45.00	3
5	87.71	45.00	92.60	45.00	3
6	92.60	45.00	130.10	62.00	2
7	130.10	62.00	143.80	62.30	2
8	143.80	62.30	181.80	63.10	1
9	181.80	63.10	181.81	64.10	1
10	181.81	64.10	187.80	64.00	1
11	187.80	64.00	193.60	67.00	1
12	193.60	67.00	280.00	69.70	1
13	92.60	45.00	100.58	45.00	3
14	87.70	26.60	87.72	24.60	1
15	87.72	24.60	100.57	24.60	1
16	100.57	24.60	100.58	45.00	2
17	100.57	24.60	143.80	62.30	1

Default Y-Origin = 0.00(ft)  
Default X-Plus Value = 0.00(ft)  
Default Y-Plus Value = 0.00(ft)

ISOTROPIC SOIL PARAMETERS

Soil Type No.	Total Unit Wt. (pcf)	Saturated Unit Wt. (pcf)	Cohesion (psf)	Friction Angle (deg)	Pore Pressure Param. (psf)	Piez. Surface No.
1	120.0	120.0	400.0	37.0	0.00	0
2	120.0	120.0	140.0	32.0	0.00	0
3	120.0	120.0	5000.0	40.0	0.00	0

1 PIEZOMETRIC SURFACE(S) SPECIFIED

Unit Weight of Water = 62.40 (pcf)  
Piezometric Surface No. 1 Specified by 2 Coordinate Points  
Pore Pressure Inclination Factor = 0.50

Point No.	X-Water (ft)	Y-Water (ft)
1	0.00	6.30
2	280.00	8.00

BOUNDARY LOAD(S)

Load No.	X-Left (ft)	X-Right (ft)	Intensity (psf)	Deflection (deg)
1				

1 135.00 177.00 250.0 0.0  
NOTE - Intensity Is Specified As A Uniformly Distributed  
Force Acting On A Horizontally Projected Surface.  
Specified Peak Ground Acceleration Coefficient (A) = 0.180(g)  
Specified Horizontal Earthquake Coefficient (kh) = 0.180(g)  
Specified Vertical Earthquake Coefficient (kv) = 0.000(g)  
Specified Seismic Pore-Pressure Factor = 0.000  
A Critical Failure Surface Searching Method, Using A Random  
Technique For Generating Circular Surfaces, Has Been Specified.  
5000 Trial Surfaces Have Been Generated.  
100 Surface(s) Initiate(s) From Each Of 50 Points Equally Spaced  
Along The Ground Surface Between X = 50.00(ft)  
and X = 80.00(ft)  
Each Surface Terminates Between X = 120.00(ft)  
and X = 160.00(ft)

Unless Further Limitations Were Imposed, The Minimum Elevation  
At Which A Surface Extends Is Y = 0.00(ft)  
5.00(ft) Line Segments Define Each Trial Failure Surface.  
Following Are Displayed The Ten Most Critical Of The Trial  
Failure Surfaces Evaluated. They Are  
Ordered - Most Critical First.

\* \* Safety Factors Are Calculated By The Modified Bishop Method \* \*  
Total Number of Trial Surfaces Attempted = 5000  
Number of Trial Surfaces With Valid FS = 5000  
Statistical Data On All Valid FS Values:  
FS Max = 3.194 FS Min = 1.748 FS Ave = 2.245  
Standard Deviation = 0.264 Coefficient of Variation = 11.77 %

Point No.	X-Surf (ft)	Y-Surf (ft)	Circle Center At X =	Y =	and Radius =
1	59.796	25.775	81.996	83.063	61.439
2	64.528	24.160			
3	69.375	22.934			
4	74.306	22.107			
5	79.288	21.684			
6	84.288	21.667			
7	89.273	22.056			
8	94.210	22.850			
9	99.065	24.043			
10	103.808	25.626			
11	108.406	27.590			
12	112.830	29.921			
13	117.049	32.604			
14	121.036	35.622			
15	124.764	38.953			
16	128.209	42.577			
17	131.348	46.469			
18	134.160	50.603			
19	136.627	54.952			
20	138.732	59.488			
21	139.736	62.211			

Factor of Safety										
*** 1.748 ***										
Individual data on the 29 slices										
Slice No.	Width (ft)	Weight (lbs)	Water Top (lbs)	Water Bot (lbs)	Tie Force Norm (lbs)	Tie Force Tan (lbs)	Earthquake Hor (lbs)	Earthquake Ver (lbs)	Surcharge Load (lbs)	
1	4.7	498.4	0.0	0.0	0.0	0.0	89.7	0.0	0.0	
2	4.8	1419.2	0.0	0.0	0.0	0.0	255.5	0.0	0.0	
3	4.9	2136.5	0.0	0.0	0.0	0.0	384.6	0.0	0.0	
4	5.0	2620.0	0.0	0.0	0.0	0.0	471.6	0.0	0.0	
5	5.0	2850.0	0.0	0.0	0.0	0.0	513.0	0.0	0.0	
6	3.4	1944.4	0.0	0.0	0.0	0.0	350.0	0.0	0.0	
7	0.0	16.7	0.0	0.0	0.0	0.0	3.0	0.0	0.0	
8	0.0	27.7	0.0	0.0	0.0	0.0	5.0	0.0	0.0	
9	1.6	4287.5	0.0	0.0	0.0	0.0	771.8	0.0	0.0	
10	3.3	9052.8	0.0	0.0	0.0	0.0	1629.5	0.0	0.0	
11	1.6	4374.2	0.0	0.0	0.0	0.0	787.3	0.0	0.0	

12	4.9	13625.5	0.0	0.0	0.0	0.0	2452.6	0.0	0.0
13	1.5	4329.2	0.0	0.0	0.0	0.0	779.3	0.0	0.0
14	0.0	28.9	0.0	0.0	0.0	0.0	5.2	0.0	0.0
15	3.2	9398.4	0.0	0.0	0.0	0.0	1691.7	0.0	0.0
16	4.6	13527.1	0.0	0.0	0.0	0.0	2434.9	0.0	0.0
17	4.4	12958.0	0.0	0.0	0.0	0.0	2332.4	0.0	0.0
18	4.2	12082.2	0.0	0.0	0.0	0.0	2174.8	0.0	0.0
19	4.0	10943.6	0.0	0.0	0.0	0.0	1969.9	0.0	0.0
20	3.7	9596.1	0.0	0.0	0.0	0.0	1727.3	0.0	0.0
21	3.4	8101.5	0.0	0.0	0.0	0.0	1458.3	0.0	0.0
22	1.9	4044.2	0.0	0.0	0.0	0.0	728.0	0.0	0.0
23	1.2	2443.9	0.0	0.0	0.0	0.0	439.9	0.0	0.0
24	2.8	4563.2	0.0	0.0	0.0	0.0	821.4	0.0	0.0
25	0.8	1083.8	0.0	0.0	0.0	0.0	195.1	0.0	0.0
26	1.6	1680.4	0.0	0.0	0.0	0.0	302.5	0.0	406.7
27	0.9	642.0	0.0	0.0	0.0	0.0	115.6	0.0	212.9
28	1.3	607.3	0.0	0.0	0.0	0.0	109.3	0.0	313.3
29	1.0	162.7	0.0	0.0	0.0	0.0	29.3	0.0	250.9

Failure Surface Specified By 22 Coordinate Points

Point No.	X-Surf (ft)	Y-Surf (ft)
1	61.020	25.811
2	65.811	24.380
3	70.693	23.300
4	75.640	22.576
5	80.627	22.212
6	85.627	22.210
7	90.614	22.569
8	95.562	23.289
9	100.445	24.365
10	105.237	25.792
11	109.913	27.562
12	114.449	29.665
13	118.821	32.092
14	123.006	34.828
15	126.981	37.861
16	130.727	41.173
17	134.223	44.747
18	137.451	48.566
19	140.394	52.608
20	143.037	56.852
21	145.366	61.276
22	145.832	62.343

Circle Center At X = 83.160 ; Y = 91.128 ; and Radius = 68.966

Factor of Safety  
\*\*\* 1.749 \*\*\*

Failure Surface Specified By 21 Coordinate Points

Point No.	X-Surf (ft)	Y-Surf (ft)
1	64.082	25.902
2	68.882	24.504
3	73.776	23.481
4	78.735	22.838
5	83.728	22.580
6	88.727	22.709
7	93.700	23.222
8	98.619	24.118
9	103.454	25.391
10	108.177	27.034
11	112.759	29.036
12	117.172	31.385
13	121.391	34.069
14	125.391	37.070
15	129.146	40.370
16	132.636	43.951
17	135.839	47.790
18	138.736	51.865
19	141.311	56.152
20	143.546	60.624
21	144.231	62.309

Circle Center At X = 84.567 ; Y = 87.310 ; and Radius = 64.735

Factor of Safety  
\*\*\* 1.749 \*\*\*

Failure Surface Specified By 22 Coordinate Points

Point No.	X-Surf (ft)	Y-Surf (ft)
1	60.408	25.793
2	65.176	24.287
3	70.044	23.146
4	74.984	22.375
5	79.969	21.980
6	84.969	21.963
7	89.955	22.324
8	94.901	23.060
9	99.777	24.168
10	104.555	25.642
11	109.208	27.472
12	113.709	29.649
13	118.033	32.159
14	122.155	34.989
15	126.052	38.122
16	129.700	41.541
17	133.080	45.226
18	136.171	49.156
19	138.957	53.308
20	141.421	57.658
21	143.550	62.183
22	143.593	62.295

Circle Center At X = 82.695 ; Y = 88.039 ; and Radius = 66.115

Factor of Safety  
\*\*\* 1.751 \*\*\*

Failure Surface Specified By 21 Coordinate Points

Point No.	X-Surf (ft)	Y-Surf (ft)
1	67.143	25.992
2	71.973	24.700
3	76.886	23.773
4	81.855	23.217
5	86.852	23.035
6	91.848	23.228
7	96.816	23.795
8	101.727	24.733
9	106.554	26.036
10	111.270	27.697
11	115.849	29.707
12	120.263	32.054
13	124.490	34.726
14	128.504	37.707
15	132.284	40.980
16	135.807	44.527
17	139.055	48.329
18	142.009	52.363
19	144.652	56.608
20	146.970	61.038
21	147.548	62.379

Circle Center At X = 86.779 ; Y = 89.703 ; and Radius = 66.668

Factor of Safety  
\*\*\* 1.751 \*\*\*

Failure Surface Specified By 22 Coordinate Points

Point No.	X-Surf (ft)	Y-Surf (ft)
1	63.469	25.884
2	68.300	24.592
3	73.207	23.632
4	78.168	23.010
5	83.160	22.727
6	88.159	22.785
7	93.143	23.185
8	98.089	23.923
9	102.972	24.997

10	107.771	26.402
11	112.462	28.130
12	117.025	30.175
13	121.438	32.526
14	125.680	35.172
15	129.732	38.102
16	133.574	41.301
17	137.190	44.755
18	140.561	48.447
19	143.673	52.361
20	146.510	56.478
21	149.060	60.779
22	149.891	62.428

Circle Center At X = 84.808 ; Y = 95.881 ; and Radius = 73.178

Factor of Safety  
\*\*\* 1.752 \*\*\*

Failure Surface Specified By 21 Coordinate Points

Point No.	X-Surf (ft)	Y-Surf (ft)
1	62.245	25.847
2	67.016	24.350
3	71.887	23.224
4	76.831	22.475
5	81.817	22.108
6	86.817	22.125
7	91.801	22.525
8	96.740	23.307
9	101.603	24.466
10	106.364	25.994
11	110.993	27.884
12	115.464	30.123
13	119.749	32.699
14	123.824	35.597
15	127.664	38.798
16	131.248	42.285
17	134.553	46.037
18	137.560	50.032
19	140.252	54.245
20	142.612	58.653
21	144.222	62.309

Circle Center At X = 84.101 ; Y = 87.150 ; and Radius = 65.082

Factor of Safety  
\*\*\* 1.753 \*\*\*

Failure Surface Specified By 23 Coordinate Points

Point No.	X-Surf (ft)	Y-Surf (ft)
1	57.347	25.703
2	62.135	24.264
3	67.010	23.153
4	71.949	22.374
5	76.930	21.932
6	81.929	21.828
7	86.923	22.063
8	91.890	22.636
9	96.807	23.543
10	101.651	24.782
11	106.401	26.346
12	111.033	28.228
13	115.527	30.419
14	119.863	32.909
15	124.020	35.688
16	127.979	38.742
17	131.722	42.056
18	135.232	45.617
19	138.493	49.407
20	141.490	53.410
21	144.209	57.606
22	146.638	61.976
23	146.820	62.364

Circle Center At X = 80.962 ; Y = 95.608 ; and Radius = 73.787

Factor of Safety  
\*\*\* 1.753 \*\*\*

Failure Surface Specified By 21 Coordinate Points

Point No.	X-Surf (ft)	Y-Surf (ft)
1	66.531	25.974
2	71.348	24.635
3	76.253	23.664
4	81.217	23.067
5	86.212	22.849
6	91.210	23.009
7	96.181	23.547
8	101.096	24.461
9	105.929	25.744
10	110.650	27.389
11	115.234	29.388
12	119.652	31.728
13	123.881	34.395
14	127.896	37.376
15	131.673	40.652
16	135.191	44.205
17	138.430	48.014
18	141.371	52.057
19	143.997	56.312
20	146.294	60.753
21	146.979	62.367

Circle Center At X = 86.598 ; Y = 88.807 ; and Radius = 65.959

Factor of Safety  
\*\*\* 1.754 \*\*\*

Failure Surface Specified By 21 Coordinate Points

Point No.	X-Surf (ft)	Y-Surf (ft)
1	65.306	25.938
2	70.137	24.650
3	75.047	23.706
4	80.012	23.111
5	85.006	22.868
6	90.005	22.978
7	94.983	23.441
8	99.917	24.255
9	104.780	25.415
10	109.550	26.915
11	114.201	28.748
12	118.712	30.906
13	123.059	33.376
14	127.221	36.147
15	131.177	39.206
16	134.906	42.535
17	138.392	46.120
18	141.615	49.943
19	144.561	53.983
20	147.214	58.221
21	149.446	62.419

Circle Center At X = 85.944 ; Y = 93.625 ; and Radius = 70.763

Factor of Safety  
\*\*\* 1.755 \*\*\*

\*\*\*\* END OF GSTABL7 OUTPUT \*\*\*\*



# 12091-01 / John S. Gibson / Sec. E-E' / Static / Keyway 20'

z:\2012\12091-01 howard industrial partners - john s gibbon blvd\engineering\slope stability\sections\e-e'\exl2.pl2 Run By: SHH 3/14/2019 12:43PM

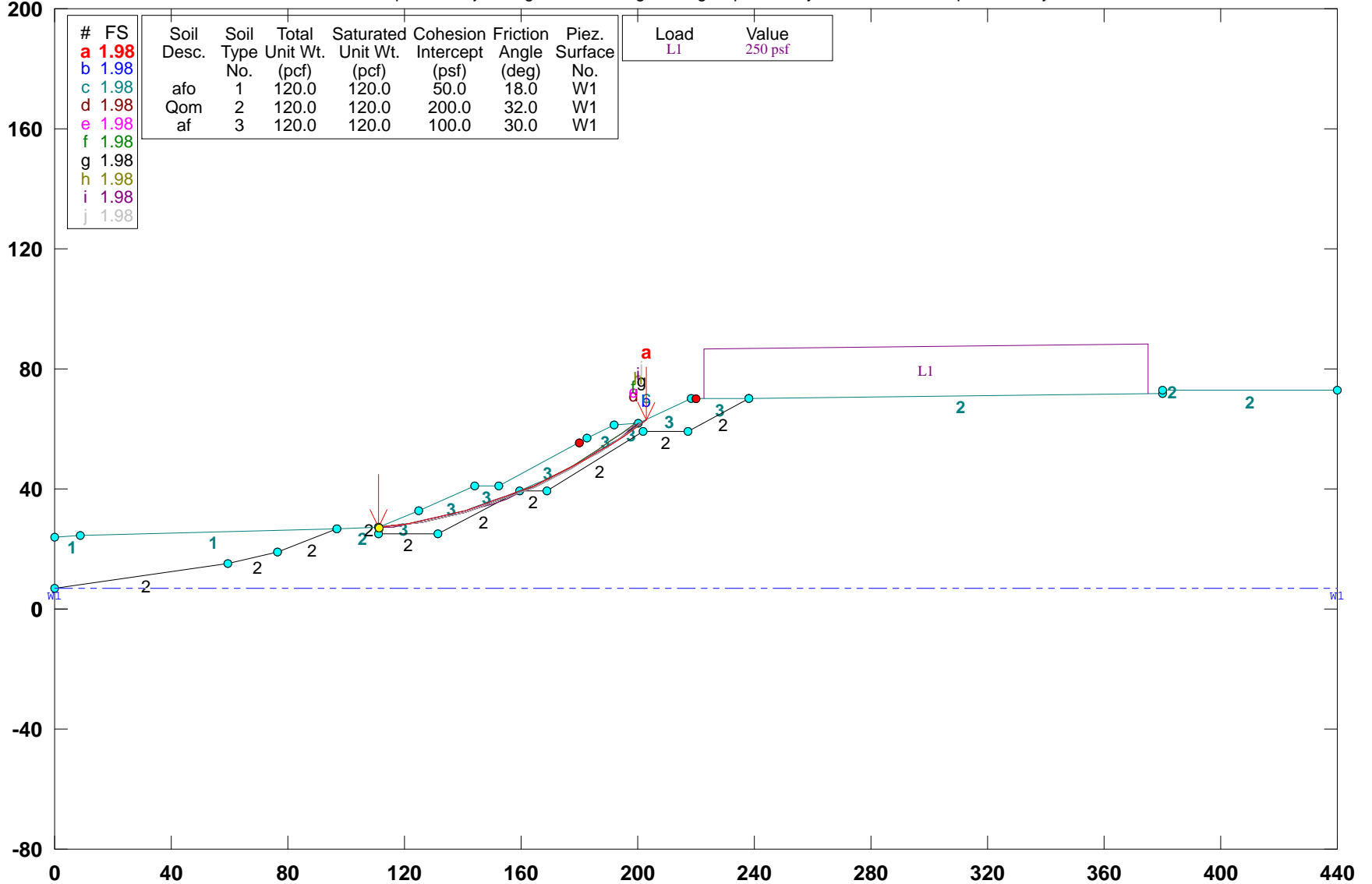

GSTABL7 v.2 FSmin=1.98  
Safety Factors Are Calculated By The Modified Bishop Method



10	4.8	3399.2	0.0	0.0	0.	0.	0.0	0.0	0.0
11	2.2	1242.3	0.0	0.0	0.	0.	0.0	0.0	0.0
12	2.6	1430.5	0.0	0.0	0.	0.	0.0	0.0	0.0
13	3.7	2266.5	0.0	0.0	0.	0.	0.0	0.0	0.0
14	1.0	646.1	0.0	0.0	0.	0.	0.0	0.0	0.0
15	0.1	40.0	0.0	0.0	0.	0.	0.0	0.0	0.0
16	0.3	214.5	0.0	0.0	0.	0.	0.0	0.0	0.0
17	4.2	2953.6	0.0	0.0	0.	0.	0.0	0.0	0.0
18	4.6	3416.0	0.0	0.0	0.	0.	0.0	0.0	0.0
19	4.5	3538.6	0.0	0.0	0.	0.	0.0	0.0	0.0
20	4.5	3578.0	0.0	0.0	0.	0.	0.0	0.0	0.0
21	4.4	3536.9	0.0	0.0	0.	0.	0.0	0.0	0.0
22	0.3	277.5	0.0	0.0	0.	0.	0.0	0.0	0.0
23	4.0	3158.8	0.0	0.0	0.	0.	0.0	0.0	0.0
24	4.3	3284.6	0.0	0.0	0.	0.	0.0	0.0	0.0
25	0.8	606.1	0.0	0.0	0.	0.	0.0	0.0	0.0
26	3.4	2088.5	0.0	0.0	0.	0.	0.0	0.0	0.0
27	4.1	1332.8	0.0	0.0	0.	0.	0.0	0.0	0.0
28	0.7	93.6	0.0	0.0	0.	0.	0.0	0.0	0.0
29	3.1	144.3	0.0	0.0	0.	0.	0.0	0.0	0.0

Failure Surface Specified By 21 Coordinate Points

Point No.	X-Surf (ft)	Y-Surf (ft)
1	111.300	27.000
2	116.256	27.663
3	121.193	28.453
4	126.109	29.368
5	130.999	30.409
6	135.862	31.574
7	140.693	32.862
8	145.489	34.274
9	150.248	35.807
10	154.967	37.461
11	159.641	39.236
12	164.269	41.129
13	168.847	43.139
14	173.373	45.265
15	177.842	47.507
16	182.253	49.861
17	186.602	52.328
18	190.887	54.904
19	195.105	57.589
20	199.253	60.381
21	203.064	63.090

Circle Center At X = 87.784 ; Y = 221.523 ; and Radius = 195.939

Factor of Safety  
\*\*\* 1.978 \*\*\*

Failure Surface Specified By 21 Coordinate Points

Point No.	X-Surf (ft)	Y-Surf (ft)
1	111.300	27.000
2	116.251	27.698
3	121.183	28.519
4	126.094	29.461
5	130.979	30.526
6	135.836	31.711
7	140.663	33.017
8	145.456	34.441
9	150.212	35.985
10	154.928	37.646
11	159.601	39.423
12	164.229	41.316
13	168.808	43.323
14	173.337	45.443
15	177.811	47.675
16	182.228	50.017
17	186.586	52.468
18	190.882	55.027
19	195.113	57.691
20	199.277	60.460

21 202.958 63.042  
Circle Center At X = 85.653 ; Y = 226.823 ; and Radius = 201.462  
Factor of Safety  
\*\*\* 1.978 \*\*\*

Failure Surface Specified By 21 Coordinate Points

Point No.	X-Surf (ft)	Y-Surf (ft)
1	111.300	27.000
2	116.270	27.543
3	121.222	28.234
4	126.152	29.073
5	131.053	30.059
6	135.924	31.191
7	140.758	32.468
8	145.552	33.889
9	150.301	35.452
10	155.001	37.157
11	159.649	39.002
12	164.239	40.984
13	168.768	43.103
14	173.231	45.356
15	177.625	47.742
16	181.946	50.258
17	186.190	52.902
18	190.353	55.671
19	194.431	58.564
20	198.421	61.578
21	198.552	61.683

Circle Center At X = 95.622 ; Y = 193.545 ; and Radius = 167.281

Factor of Safety  
\*\*\* 1.979 \*\*\*

Failure Surface Specified By 21 Coordinate Points

Point No.	X-Surf (ft)	Y-Surf (ft)
1	111.300	27.000
2	116.270	27.543
3	121.222	28.234
4	126.152	29.073
5	131.053	30.059
6	135.924	31.191
7	140.758	32.468
8	145.552	33.889
9	150.301	35.452
10	155.001	37.157
11	159.649	39.002
12	164.239	40.984
13	168.768	43.103
14	173.231	45.356
15	177.625	47.742
16	181.946	50.258
17	186.190	52.902
18	190.353	55.671
19	194.431	58.564
20	198.421	61.578
21	198.552	61.683

Circle Center At X = 95.623 ; Y = 193.541 ; and Radius = 167.278

Factor of Safety  
\*\*\* 1.979 \*\*\*

Failure Surface Specified By 21 Coordinate Points

Point No.	X-Surf (ft)	Y-Surf (ft)
1	111.300	27.000
2	116.271	27.541
3	121.223	28.230
4	126.152	29.068
5	131.054	30.052
6	135.925	31.183
7	140.759	32.459
8	145.553	33.879
9	150.303	35.442

10	155.003	37.147
11	159.651	38.991
12	164.241	40.974
13	168.769	43.093
14	173.233	45.347
15	177.626	47.733
16	181.947	50.250
17	186.190	52.895
18	190.352	55.666
19	194.429	58.560
20	198.418	61.574
21	198.553	61.683

Circle Center At X = 95.715 ; Y = 193.316 ; and Radius = 167.045  
Factor of Safety  
\*\*\* 1.979 \*\*\*

Failure Surface Specified By 21 Coordinate Points

Point No.	X-Surf (ft)	Y-Surf (ft)
1	111.300	27.000
2	116.269	27.559
3	121.220	28.258
4	126.149	29.096
5	131.053	30.072
6	135.927	31.186
7	140.768	32.437
8	145.572	33.823
9	150.335	35.345
10	155.053	36.999
11	159.723	38.786
12	164.340	40.704
13	168.902	42.751
14	173.404	44.926
15	177.844	47.226
16	182.217	49.651
17	186.519	52.198
18	190.749	54.865
19	194.901	57.650
20	198.974	60.551
21	201.238	62.262

Circle Center At X = 93.933 ; Y = 203.713 ; and Radius = 177.564  
Factor of Safety  
\*\*\* 1.983 \*\*\*

Failure Surface Specified By 21 Coordinate Points

Point No.	X-Surf (ft)	Y-Surf (ft)
1	111.300	27.000
2	116.274	27.511
3	121.231	28.168
4	126.166	28.970
5	131.075	29.917
6	135.955	31.009
7	140.800	32.243
8	145.607	33.620
9	150.371	35.137
10	155.088	36.794
11	159.755	38.590
12	164.367	40.521
13	168.919	42.588
14	173.410	44.788
15	177.833	47.119
16	182.186	49.579
17	186.465	52.166
18	190.665	54.878
19	194.784	57.712
20	198.818	60.667
21	200.347	61.857

Circle Center At X = 96.440 ; Y = 196.217 ; and Radius = 169.868  
Factor of Safety  
\*\*\* 1.984 \*\*\*

Failure Surface Specified By 21 Coordinate Points

Point No.	X-Surf (ft)	Y-Surf (ft)
1	111.300	27.000
2	116.274	27.509
3	121.231	28.164
4	126.166	28.964
5	131.076	29.910
6	135.956	31.000
7	140.801	32.234
8	145.608	33.610
9	150.373	35.127
10	155.090	36.783
11	159.757	38.578
12	164.369	40.510
13	168.921	42.577
14	173.411	44.777
15	177.834	47.109
16	182.187	49.570
17	186.465	52.158
18	190.665	54.871
19	194.783	57.706
20	198.816	60.662
21	200.353	61.860

Circle Center At X = 96.535 ; Y = 195.979 ; and Radius = 169.623  
Factor of Safety  
\*\*\* 1.984 \*\*\*

Failure Surface Specified By 21 Coordinate Points

Point No.	X-Surf (ft)	Y-Surf (ft)
1	111.300	27.000
2	116.271	27.542
3	121.224	28.225
4	126.155	29.049
5	131.061	30.013
6	135.938	31.117
7	140.781	32.360
8	145.587	33.740
9	150.351	35.256
10	155.071	36.908
11	159.741	38.693
12	164.359	40.611
13	168.920	42.660
14	173.420	44.838
15	177.857	47.143
16	182.226	49.574
17	186.525	52.129
18	190.748	54.805
19	194.894	57.600
20	198.958	60.513
21	201.285	62.283

Circle Center At X = 94.787 ; Y = 201.591 ; and Radius = 175.370  
Factor of Safety  
\*\*\* 1.984 \*\*\*

\*\*\*\* END OF GSTABL7 OUTPUT \*\*\*\*

# 12091-01 / John S. Gibson / Sec. E-E' / Seismic / Keyway 20'

z:\2012\12091-01 howard industrial partners - john s gibson blvd\engineering\slope stability\sections\le-e'\exl2e.pl2 Run By: SHH 3/14/2019 12:44PM

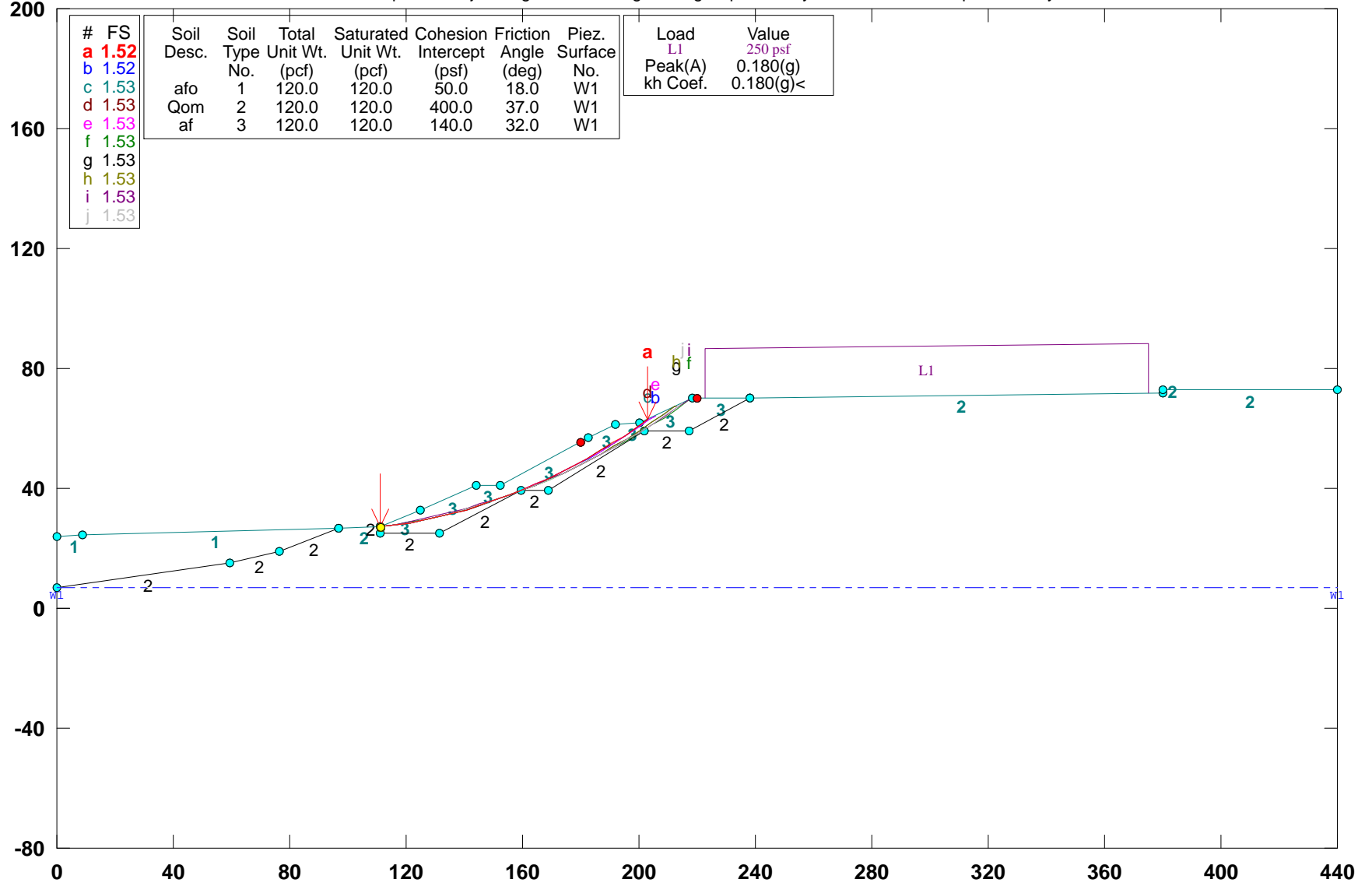

GSTABL7 v.2 FSmin=1.52

Safety Factors Are Calculated By The Modified Bishop Method

\*\*\* GSTABL7 \*\*\*

\*\* GSTABL7 by Dr. Garry H. Gregory, Ph.D., P.E., D.GE \*\*

\*\* Original Version 1.0, January 1996; Current Ver. 2.005.3, Feb. 2013 \*\*  
(All Rights Reserved-Unauthorised Use Prohibited)

\*\*\*\*\*

SLOPE STABILITY ANALYSIS SYSTEM

Modified Bishop, Simplified Janbu, or GLE Method of Slices.  
(Includes Spencer & Morgenstern-Price Type Analysis)  
Including Pier/Pile, Reinforcement, Soil Nail, Tieback,  
Nonlinear Undrained Shear Strength, Curved Phi Envelope,  
Anisotropic Soil, Fiber-Reinforced Soil, Boundary Loads, Water  
Surfaces, Pseudo-Static & Newmark Earthquake, and Applied Forces.

\*\*\*\*\*

Analysis Run Date: 3/14/2019

Time of Run: 12:44PM

Run By: SHH

Input Data Filename: z:\2012\12091-01 Howard Industrial Partners - John S Gibson

Blvd\Engineering\Slope Stability\Sections\E-E'\exl2e.in

Output Filename: z:\2012\12091-01 Howard Industrial Partners - John S Gibson

Blvd\Engineering\Slope Stability\Sections\E-E'\exl2e.OUT

Unit System: English

Plotted Output Filename: z:\2012\12091-01 Howard Industrial Partners - John S Gibson

Blvd\Engineering\Slope Stability\Sections\E-E'\exl2e.PLT

PROBLEM DESCRIPTION: 12091-01 / John S. Gibson / Sec. E-E' /  
Seismic / Keyway 20'

BOUNDARY COORDINATES

14 Top Boundaries

24 Total Boundaries

Boundary No.	X-Left (ft)	Y-Left (ft)	X-Right (ft)	Y-Right (ft)	Soil Type Below Bnd
1	0.00	24.00	9.00	24.50	1
2	9.00	24.50	96.60	26.50	1
3	96.60	26.50	111.30	27.00	2
4	111.30	27.00	125.00	32.80	3
5	125.00	32.80	144.30	41.00	3
6	144.30	41.00	152.40	41.00	3
7	152.40	41.00	182.60	56.70	3
8	182.60	56.70	191.70	61.60	3
9	191.70	61.60	200.00	61.70	3
10	200.00	61.70	218.30	70.00	3
11	218.30	70.00	238.30	70.20	3
12	238.30	70.20	379.90	72.00	2
13	379.90	72.00	379.91	73.00	2
14	379.91	73.00	440.00	73.00	2
15	0.00	7.00	59.20	15.10	2
16	59.20	15.10	76.30	19.10	2
17	76.30	19.10	96.60	26.50	2
18	111.30	27.00	111.31	25.00	2
19	111.31	25.00	131.30	25.00	2
20	131.30	25.00	159.70	39.40	2
21	159.70	39.40	169.10	39.40	2
22	169.10	39.40	201.80	59.30	2
23	201.80	59.30	217.30	59.30	2
24	217.30	59.30	238.30	70.20	2

Default Y-Origin = 0.00(ft)

Default X-Plus Value = 0.00(ft)

Default Y-Plus Value = 0.00(ft)

ISOTROPIC SOIL PARAMETERS

3 Type(s) of Soil

Soil Type No.	Total Wt. (pcf)	Saturated Wt. (pcf)	Cohesion (psf)	Friction Angle (deg)	Pore Pressure Param. (psf)	Pressure Constant	Piez. Surface
1	120.0	120.0	50.0	18.0	0.00	0.0	1
2	120.0	120.0	400.0	37.0	0.00	0.0	1
3	120.0	120.0	140.0	32.0	0.00	0.0	1

1 PIEZOMETRIC SURFACE(S) SPECIFIED

Unit Weight of Water = 62.00 (pcf)

Piezometric Surface No. 1 Specified by 2 Coordinate Points

Pore Pressure Inclination Factor = 0.50

Point X-Water Y-Water

No.	(ft)	(ft)
1	0.00	7.00
2	440.00	7.00

BOUNDARY LOAD(S)

1 Load(s) Specified

Load No.	X-Left (ft)	X-Right (ft)	Intensity (psf)	Deflection (deg)
1	223.00	375.00	250.0	0.0

NOTE - Intensity Is Specified As A Uniformly Distributed Force Acting On A Horizontally Projected Surface.

Specified Peak Ground Acceleration Coefficient (A) = 0.180(g)

Specified Horizontal Earthquake Coefficient (kh) = 0.180(g)

Specified Vertical Earthquake Coefficient (kv) = 0.000(g)

Specified Seismic Pore-Pressure Factor = 0.000

A Critical Failure Surface Searching Method, Using A Random Technique For Generating Circular Surfaces, Has Been Specified.

5000 Trial Surfaces Have Been Generated.

250 Surface(s) Initiate(s) From Each Of 20 Points Equally Spaced

Along The Ground Surface Between X = 111.30(ft)

and X = 111.30(ft)

Each Surface Terminates Between X = 180.00(ft)

and X = 220.00(ft)

Unless Further Limitations Were Imposed, The Minimum Elevation

At Which A Surface Extends Is Y = 0.00(ft)

5.00(ft) Line Segments Define Each Trial Failure Surface.

Following Are Displayed The Ten Most Critical Of The Trial

Failure Surfaces Evaluated. They Are

Ordered - Most Critical First.

\* \* Safety Factors Are Calculated By The Modified Bishop Method \* \*

Total Number of Trial Surfaces Attempted = 5000

Number of Trial Surfaces With Valid FS = 5000

Statistical Data On All Valid FS Values:

FS Max = 3.116 FS Min = 1.520 FS Ave = 2.286

Standard Deviation = 0.372 Coefficient of Variation = 16.26 %

Failure Surface Specified By 21 Coordinate Points

Point No. X-Surf (ft) Y-Surf (ft)

1	111.300	27.000
2	116.251	27.698
3	121.183	28.519
4	126.094	29.461
5	130.979	30.526
6	135.836	31.711
7	140.663	33.017
8	145.456	34.441
9	150.212	35.985
10	154.928	37.646
11	159.601	39.423
12	164.229	41.316
13	168.808	43.323
14	173.337	45.443
15	177.811	47.675
16	182.228	50.017
17	186.586	52.468
18	190.882	55.027
19	195.113	57.691
20	199.277	60.460
21	202.958	63.042

Circle Center At X = 85.653 ; Y = 226.823 ; and Radius = 201.462

Factor of Safety

\*\*\* 1.520 \*\*\*

Individual data on the 26 slices

Slice No.	Width (ft)	Weight (lbs)	Water Force		Tie Force		Earthquake Force		Surcharge Load (lbs)
			Top (lbs)	Bot (lbs)	Norm (lbs)	Tan (lbs)	Hor (lbs)	Ver (lbs)	
1	5.0	415.3	0.0	0.0	0.0	0.0	74.8	0.0	0.0
2	4.9	1202.5	0.0	0.0	0.0	0.0	216.5	0.0	0.0
3	3.8	1423.0	0.0	0.0	0.0	0.0	256.1	0.0	0.0
4	1.1	482.4	0.0	0.0	0.0	0.0	86.8	0.0	0.0

5	4.9	2526.0	0.0	0.0	0.	0.	454.7	0.0	0.0
6	4.9	3062.4	0.0	0.0	0.	0.	551.2	0.0	0.0
7	4.8	3513.1	0.0	0.0	0.	0.	632.4	0.0	0.0
8	3.6	2911.1	0.0	0.0	0.	0.	524.0	0.0	0.0
9	1.2	933.4	0.0	0.0	0.	0.	168.0	0.0	0.0
10	4.8	3302.6	0.0	0.0	0.	0.	594.5	0.0	0.0
11	2.2	1215.9	0.0	0.0	0.	0.	218.9	0.0	0.0
12	2.5	1351.7	0.0	0.0	0.	0.	243.3	0.0	0.0
13	4.7	2800.9	0.0	0.0	0.	0.	504.2	0.0	0.0
14	4.6	3097.2	0.0	0.0	0.	0.	557.5	0.0	0.0
15	4.6	3308.4	0.0	0.0	0.	0.	595.5	0.0	0.0
16	4.5	3436.4	0.0	0.0	0.	0.	618.6	0.0	0.0
17	4.5	3483.5	0.0	0.0	0.	0.	627.0	0.0	0.0
18	4.4	3452.2	0.0	0.0	0.	0.	621.4	0.0	0.0
19	0.4	289.1	0.0	0.0	0.	0.	52.0	0.0	0.0
20	4.0	3073.8	0.0	0.0	0.	0.	553.3	0.0	0.0
21	4.3	3224.6	0.0	0.0	0.	0.	580.4	0.0	0.0
22	0.8	598.3	0.0	0.0	0.	0.	107.7	0.0	0.0
23	3.4	2049.5	0.0	0.0	0.	0.	368.9	0.0	0.0
24	4.2	1294.4	0.0	0.0	0.	0.	233.0	0.0	0.0
25	0.7	85.3	0.0	0.0	0.	0.	15.3	0.0	0.0
26	3.0	130.1	0.0	0.0	0.	0.	23.4	0.0	0.0

Failure Surface Specified By 22 Coordinate Points

Point No.	X-Surf (ft)	Y-Surf (ft)
1	111.300	27.000
2	116.248	27.722
3	121.177	28.561
4	126.084	29.517
5	130.968	30.589
6	135.825	31.776
7	140.653	33.078
8	145.448	34.494
9	150.209	36.023
10	154.932	37.664
11	159.614	39.417
12	164.254	41.280
13	168.849	43.253
14	173.395	45.334
15	177.891	47.522
16	182.334	49.816
17	186.721	52.214
18	191.050	54.716
19	195.318	57.319
20	199.524	60.023
21	203.665	62.826
22	205.738	64.302

Circle Center At X = 83.352 ; Y = 235.949 ; and Radius = 210.810

Factor of Safety  
\*\*\* 1.524 \*\*\*

Failure Surface Specified By 21 Coordinate Points

Point No.	X-Surf (ft)	Y-Surf (ft)
1	111.300	27.000
2	116.256	27.663
3	121.193	28.453
4	126.108	29.372
5	130.998	30.414
6	135.860	31.579
7	140.691	32.869
8	145.488	34.281
9	150.247	35.815
10	154.965	37.469
11	159.640	39.243
12	164.268	41.136
13	168.846	43.147
14	173.371	45.273
15	177.841	47.514
16	182.252	49.868
17	186.602	52.333

18	190.887	54.909
19	195.106	57.593
20	199.254	60.384
21	203.060	63.088

Circle Center At X = 87.697 ; Y = 221.739 ; and Radius = 196.164

Factor of Safety  
\*\*\* 1.526 \*\*\*

Failure Surface Specified By 21 Coordinate Points

Point No.	X-Surf (ft)	Y-Surf (ft)
1	111.300	27.000
2	116.256	27.663
3	121.193	28.453
4	126.109	29.368
5	130.999	30.409
6	135.862	31.574
7	140.693	32.862
8	145.489	34.274
9	150.248	35.807
10	154.967	37.461
11	159.641	39.236
12	164.269	41.129
13	168.847	43.139
14	173.373	45.265
15	177.842	47.507
16	182.253	49.861
17	186.602	52.328
18	190.887	54.904
19	195.105	57.589
20	199.253	60.381
21	203.064	63.090

Circle Center At X = 87.784 ; Y = 221.523 ; and Radius = 195.939

Factor of Safety  
\*\*\* 1.527 \*\*\*

Failure Surface Specified By 22 Coordinate Points

Point No.	X-Surf (ft)	Y-Surf (ft)
1	111.300	27.000
2	116.246	27.733
3	121.173	28.581
4	126.080	29.545
5	130.962	30.624
6	135.817	31.818
7	140.643	33.125
8	145.438	34.545
9	150.197	36.077
10	154.919	37.721
11	159.601	39.475
12	164.241	41.338
13	168.836	43.310
14	173.383	45.389
15	177.880	47.574
16	182.325	49.865
17	186.714	52.259
18	191.047	54.756
19	195.319	57.353
20	199.529	60.050
21	203.675	62.846
22	205.715	64.292

Circle Center At X = 82.636 ; Y = 237.734 ; and Radius = 212.675

Factor of Safety  
\*\*\* 1.527 \*\*\*

Failure Surface Specified By 25 Coordinate Points

Point No.	X-Surf (ft)	Y-Surf (ft)
1	111.300	27.000
2	116.239	27.780
3	121.161	28.660
4	126.064	29.641
5	130.945	30.722

6	135.804	31.902
7	140.638	33.182
8	145.444	34.560
9	150.221	36.036
10	154.967	37.609
11	159.680	39.279
12	164.358	41.045
13	168.998	42.906
14	173.600	44.862
15	178.161	46.911
16	182.678	49.054
17	187.152	51.288
18	191.578	53.613
19	195.956	56.028
20	200.284	58.532
21	204.560	61.124
22	208.781	63.803
23	212.948	66.568
24	217.056	69.417
25	217.126	69.468

Circle Center At X = 75.636 ; Y = 268.966 ; and Radius = 244.580  
 Factor of Safety  
 \*\*\* 1.529 \*\*\*

Failure Surface Specified By 24 Coordinate Points

Point No.	X-Surf (ft)	Y-Surf (ft)
1	111.300	27.000
2	116.242	27.757
3	121.167	28.620
4	126.072	29.590
5	130.955	30.666
6	135.814	31.847
7	140.645	33.133
8	145.448	34.523
9	150.220	36.017
10	154.958	37.614
11	159.661	39.312
12	164.326	41.112
13	168.950	43.013
14	173.533	45.013
15	178.071	47.112
16	182.563	49.308
17	187.006	51.601
18	191.398	53.990
19	195.738	56.473
20	200.023	59.050
21	204.252	61.718
22	208.421	64.478
23	212.530	67.327
24	212.738	67.477

Circle Center At X = 78.800 ; Y = 255.788 ; and Radius = 231.084  
 Factor of Safety  
 \*\*\* 1.529 \*\*\*

Failure Surface Specified By 24 Coordinate Points

Point No.	X-Surf (ft)	Y-Surf (ft)
1	111.300	27.000
2	116.243	27.755
3	121.168	28.617
4	126.073	29.586
5	130.956	30.661
6	135.815	31.841
7	140.647	33.126
8	145.450	34.515
9	150.222	36.009
10	154.960	37.605
11	159.663	39.303
12	164.328	41.103
13	168.952	43.004
14	173.535	45.004

15	178.073	47.103
16	182.564	49.300
17	187.007	51.594
18	191.399	53.983
19	195.739	56.467
20	200.023	59.045
21	204.251	61.714
22	208.420	64.475
23	212.528	67.325
24	212.737	67.477

Circle Center At X = 78.922 ; Y = 255.483 ; and Radius = 230.766  
 Factor of Safety  
 \*\*\* 1.529 \*\*\*

Failure Surface Specified By 25 Coordinate Points

Point No.	X-Surf (ft)	Y-Surf (ft)
1	111.300	27.000
2	116.233	27.815
3	121.149	28.727
4	126.046	29.737
5	130.922	30.843
6	135.776	32.045
7	140.604	33.344
8	145.406	34.737
9	150.179	36.226
10	154.922	37.808
11	159.633	39.485
12	164.309	41.254
13	168.950	43.115
14	173.553	45.068
15	178.116	47.112
16	182.638	49.245
17	187.117	51.468
18	191.551	53.779
19	195.938	56.177
20	200.277	58.662
21	204.566	61.232
22	208.803	63.886
23	212.987	66.624
24	217.116	69.444
25	217.187	69.495

Circle Center At X = 72.613 ; Y = 276.571 ; and Radius = 252.552  
 Factor of Safety  
 \*\*\* 1.531 \*\*\*

Failure Surface Specified By 24 Coordinate Points

Point No.	X-Surf (ft)	Y-Surf (ft)
1	111.300	27.000
2	116.242	27.758
3	121.167	28.620
4	126.073	29.587
5	130.957	30.658
6	135.817	31.831
7	140.652	33.108
8	145.458	34.487
9	150.234	35.967
10	154.977	37.548
11	159.686	39.229
12	164.358	41.010
13	168.991	42.890
14	173.584	44.867
15	178.133	46.941
16	182.638	49.111
17	187.095	51.376
18	191.504	53.735
19	195.861	56.187
20	200.166	58.731
21	204.416	61.365
22	208.608	64.089
23	212.743	66.901



24            214.983        68.496  
Circle Center At X =    78.075 ; Y =   260.298 ; and Radius =   235.652  
Factor of Safety  
\*\*\*    1.532    \*\*\*  
      \*\*\*\* END OF GSTABL7 OUTPUT \*\*\*\*

# 12091-01 / John S. Gibson / Sec. E-E' / Mid Slope / Static / Keyway 20'

z:\2012\12091-01 howard industrial partners - john s gibson blvd\engineering\slope stability\sections\le-e'\exl.pl2 Run By: SHH 3/14/2019 12:45PM

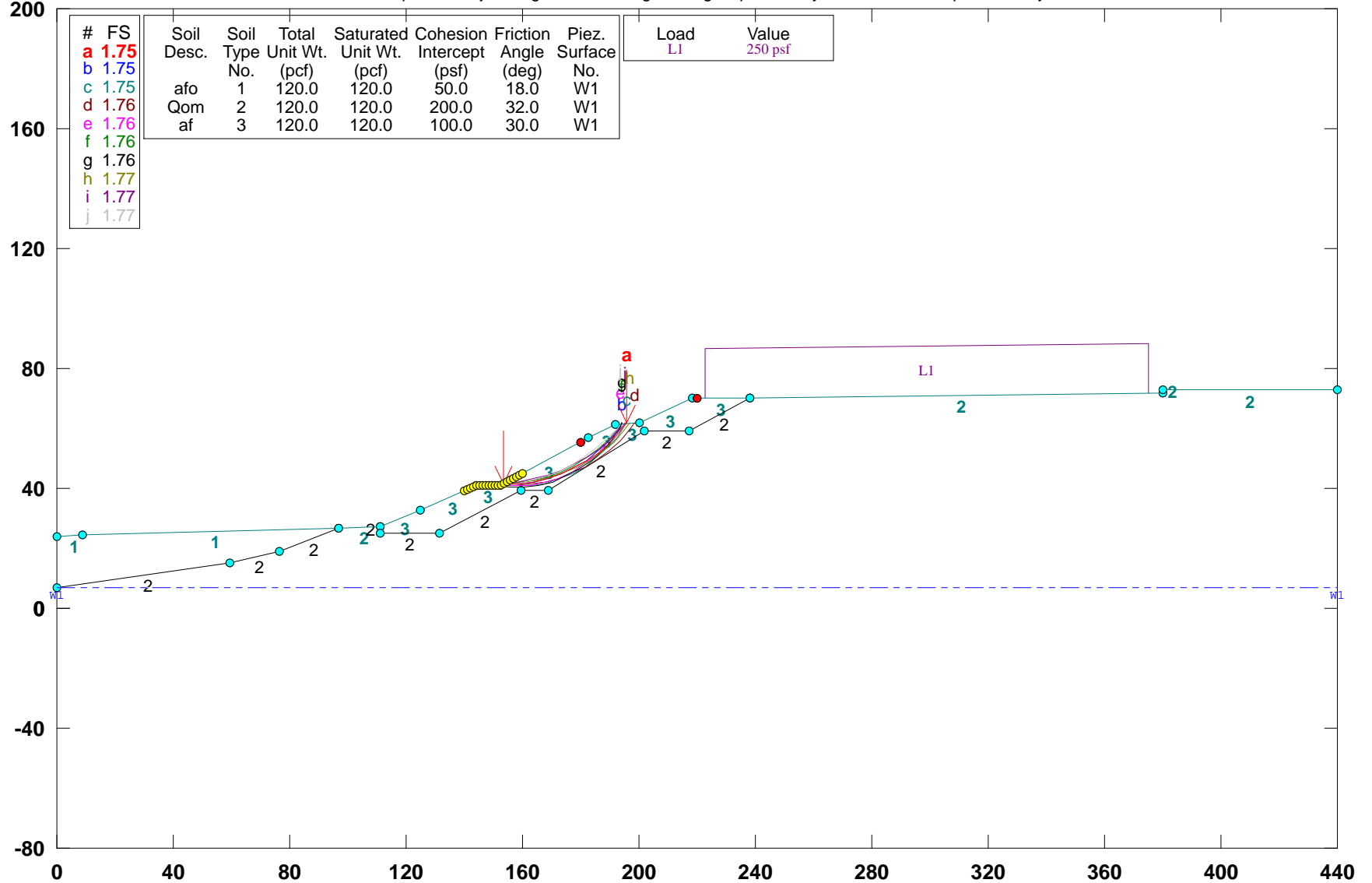

GSTABL7 v.2 FSmin=1.75  
Safety Factors Are Calculated By The Modified Bishop Method

\*\*\* GSTABL7 \*\*\*

\*\* GSTABL7 by Dr. Garry H. Gregory, Ph.D., P.E., D.GE \*\*
\*\* Original Version 1.0, January 1996; Current Ver. 2.005.3, Feb. 2013 \*\*
(All Rights Reserved-Unauthorized Use Prohibited)

SLOPE STABILITY ANALYSIS SYSTEM

Modified Bishop, Simplified Janbu, or GLE Method of Slices.
(Includes Spencer & Morgenstern-Price Type Analysis)
Including Pier/Pile, Reinforcement, Soil Nail, Tieback,
Nonlinear Undrained Shear Strength, Curved Phi Envelope,
Anisotropic Soil, Fiber-Reinforced Soil, Boundary Loads, Water
Surfaces, Pseudo-Static & Newmark Earthquake, and Applied Forces.

Analysis Run Date: 3/14/2019
Time of Run: 12:45PM
Run By: SHH

Input Data Filename: z:\2012\12091-01 Howard Industrial Partners - John S Gibson
Blvd\Engineering\Slope Stability\Sections\E-E'\exl.in
Output Filename: z:\2012\12091-01 Howard Industrial Partners - John S Gibson
Blvd\Engineering\Slope Stability\Sections\E-E'\exl.OUT
Unit System: English
Plotted Output Filename: z:\2012\12091-01 Howard Industrial Partners - John S Gibson
Blvd\Engineering\Slope Stability\Sections\E-E'\exl.PLT
PROBLEM DESCRIPTION: 12091-01 / John S. Gibson / Sec. E-E' /
Mid Slope / Static / Keyway 20'

BOUNDARY COORDINATES

14 Top Boundaries
24 Total Boundaries

Table with 6 columns: Boundary No., X-Left (ft), Y-Left (ft), X-Right (ft), Y-Right (ft), Soil Type Below Bnd. Contains 24 rows of boundary data.

Default Y-Origin = 0.00(ft)
Default X-Plus Value = 0.00(ft)
Default Y-Plus Value = 0.00(ft)

ISOTROPIC SOIL PARAMETERS

Table with 7 columns: No., Total Unit Wt. (pcf), Saturated Unit Wt. (pcf), Cohesion (psf), Friction Angle (deg), Pore Pressure Param. (psf), Piez. Surface No. Contains 3 rows of soil parameters.

1 PIEZOMETRIC SURFACE(S) SPECIFIED

Unit Weight of Water = 62.40 (pcf)
Piezometric Surface No. 1 Specified by 2 Coordinate Points
Pore Pressure Inclination Factor = 0.50
Point X-Water Y-Water
No. (ft) (ft)

Table with 2 columns: Load No., Load (psf). Values: 1, 0.00; 2, 440.00.

BOUNDARY LOAD(S)

Table with 4 columns: Load No., X-Left (ft), X-Right (ft), Intensity (psf), Deflection (deg). Values: 1, 223.00, 375.00, 250.0, 0.0.

NOTE - Intensity Is Specified As A Uniformly Distributed Force Acting On A Horizontally Projected Surface.
A Critical Failure Surface Searching Method, Using A Random Technique For Generating Circular Surfaces, Has Been Specified.
5000 Trial Surfaces Have Been Generated.
250 Surface(s) Initiate(s) From Each Of 20 Points Equally Spaced Along The Ground Surface Between X = 140.00(ft) and X = 160.00(ft).
Each Surface Terminates Between X = 180.00(ft) and X = 220.00(ft).

Unless Further Limitations Were Imposed, The Minimum Elevation At Which A Surface Extends Is Y = 0.00(ft).
5.00(ft) Line Segments Define Each Trial Failure Surface.
Following Are Displayed The Ten Most Critical Of The Trial Failure Surfaces Evaluated. They Are Ordered - Most Critical First.

\*\* Safety Factors Are Calculated By The Modified Bishop Method \*\*
Total Number of Trial Surfaces Attempted = 5000
Number of Trial Surfaces With Valid FS = 5000
Statistical Data On All Valid FS Values:
FS Max = 4.656 FS Min = 1.747 FS Ave = 2.575
Standard Deviation = 0.396 Coefficient of Variation = 15.38 %
Failure Surface Specified By 11 Coordinate Points

Table with 4 columns: Point No., X-Surf (ft), Y-Surf (ft), Circle Center At X = 155.375 ; Y = 92.624 ; and Radius = 50.984. Contains 11 rows of failure surface data.

Table with 10 columns: Slice No., Width (ft), Weight (lbs), Water Force Top (lbs), Water Force Bot (lbs), Tie Norm (lbs), Tie Tan (lbs), Earthquake Hor (lbs), Earthquake Ver (lbs), Earthquake Surcharge (lbs). Contains 12 rows of slice data.

Failure Surface Specified By 11 Coordinate Points

Table with 4 columns: Point No., X-Surf (ft), Y-Surf (ft), Circle Center At X = 155.375 ; Y = 92.624 ; and Radius = 50.984. Contains 4 rows of failure surface data.

5	173.280	44.855
6	177.820	46.950
7	182.106	49.524
8	186.089	52.547
9	189.721	55.983
10	192.960	59.792
11	194.207	61.630

Circle Center At X = 156.251 ; Y = 87.722 ; and Radius = 46.126  
 Factor of Safety  
 \*\*\* 1.752 \*\*\*

Failure Surface Specified By 12 Coordinate Points

Point No.	X-Surf (ft)	Y-Surf (ft)
1	152.632	41.120
2	157.617	40.740
3	162.613	40.932
4	167.555	41.692
5	172.378	43.011
6	177.019	44.871
7	181.417	47.249
8	185.516	50.114
9	189.260	53.427
10	192.603	57.145
11	195.499	61.221
12	195.734	61.649

Circle Center At X = 158.456 ; Y = 84.406 ; and Radius = 43.676  
 Factor of Safety  
 \*\*\* 1.753 \*\*\*

Failure Surface Specified By 12 Coordinate Points

Point No.	X-Surf (ft)	Y-Surf (ft)
1	152.632	41.120
2	157.630	40.997
3	162.618	41.341
4	167.552	42.150
5	172.389	43.417
6	177.086	45.132
7	181.602	47.278
8	185.897	49.837
9	189.935	52.786
10	193.678	56.101
11	197.096	59.751
12	198.592	61.683

Circle Center At X = 156.491 ; Y = 94.139 ; and Radius = 53.159  
 Factor of Safety  
 \*\*\* 1.757 \*\*\*

Failure Surface Specified By 11 Coordinate Points

Point No.	X-Surf (ft)	Y-Surf (ft)
1	152.632	41.120
2	157.620	40.783
3	162.613	41.056
4	167.535	41.934
5	172.313	43.406
6	176.877	45.449
7	181.158	48.032
8	185.093	51.117
9	188.622	54.659
10	191.694	58.604
11	193.500	61.622

Circle Center At X = 157.886 ; Y = 81.759 ; and Radius = 40.977  
 Factor of Safety  
 \*\*\* 1.758 \*\*\*

Failure Surface Specified By 11 Coordinate Points

Point No.	X-Surf (ft)	Y-Surf (ft)
1	153.684	41.668
2	158.677	41.926
3	163.623	42.665
4	168.474	43.876

5	173.186	45.549
6	177.715	47.667
7	182.019	50.212
8	186.058	53.159
9	189.794	56.482
10	193.193	60.149
11	194.323	61.632

Circle Center At X = 153.499 ; Y = 93.536 ; and Radius = 51.869  
 Factor of Safety  
 \*\*\* 1.758 \*\*\*

Failure Surface Specified By 12 Coordinate Points

Point No.	X-Surf (ft)	Y-Surf (ft)
1	150.526	41.000
2	155.497	40.459
3	160.497	40.504
4	165.457	41.134
5	170.309	42.340
6	174.987	44.107
7	179.425	46.409
8	183.564	49.215
9	187.345	52.486
10	190.717	56.178
11	193.633	60.239
12	194.404	61.633

Circle Center At X = 157.639 ; Y = 82.846 ; and Radius = 42.447  
 Factor of Safety  
 \*\*\* 1.762 \*\*\*

Failure Surface Specified By 11 Coordinate Points

Point No.	X-Surf (ft)	Y-Surf (ft)
1	154.737	42.215
2	159.737	42.239
3	164.710	42.751
4	169.610	43.746
5	174.390	45.214
6	179.003	47.143
7	183.406	49.512
8	187.556	52.300
9	191.415	55.480
10	194.944	59.022
11	197.108	61.665

Circle Center At X = 156.993 ; Y = 93.315 ; and Radius = 51.150  
 Factor of Safety  
 \*\*\* 1.765 \*\*\*

Failure Surface Specified By 11 Coordinate Points

Point No.	X-Surf (ft)	Y-Surf (ft)
1	153.684	41.668
2	158.664	42.121
3	163.588	42.986
4	168.424	44.258
5	173.137	45.927
6	177.695	47.983
7	182.066	50.411
8	186.220	53.193
9	190.128	56.312
10	193.764	59.744
11	195.468	61.645

Circle Center At X = 150.736 ; Y = 101.676 ; and Radius = 60.081  
 Factor of Safety  
 \*\*\* 1.766 \*\*\*

Failure Surface Specified By 11 Coordinate Points

Point No.	X-Surf (ft)	Y-Surf (ft)
1	152.632	41.120
2	157.613	41.551
3	162.536	42.423
4	167.363	43.728
5	172.054	45.457

6	176.574	47.596
7	180.885	50.128
8	184.955	53.033
9	188.750	56.288
10	192.241	59.868
11	193.673	61.624

Circle Center At X = 150.284 ; Y = 97.298 ; and Radius = 56.227  
Factor of Safety  
\*\*\* 1.767 \*\*\*  
\*\*\*\* END OF GSTABL7 OUTPUT \*\*\*\*

# 12091-01 / John S. Gibson / Sec. E-E' / Mid Slope / Seismic / Keyway 20'

z:\2012\12091-01 howard industrial partners - john s gibson blvd\engineering\slope stability\sections\l-e-e'\exle.pl2 Run By: SHH 3/14/2019 12:47PM

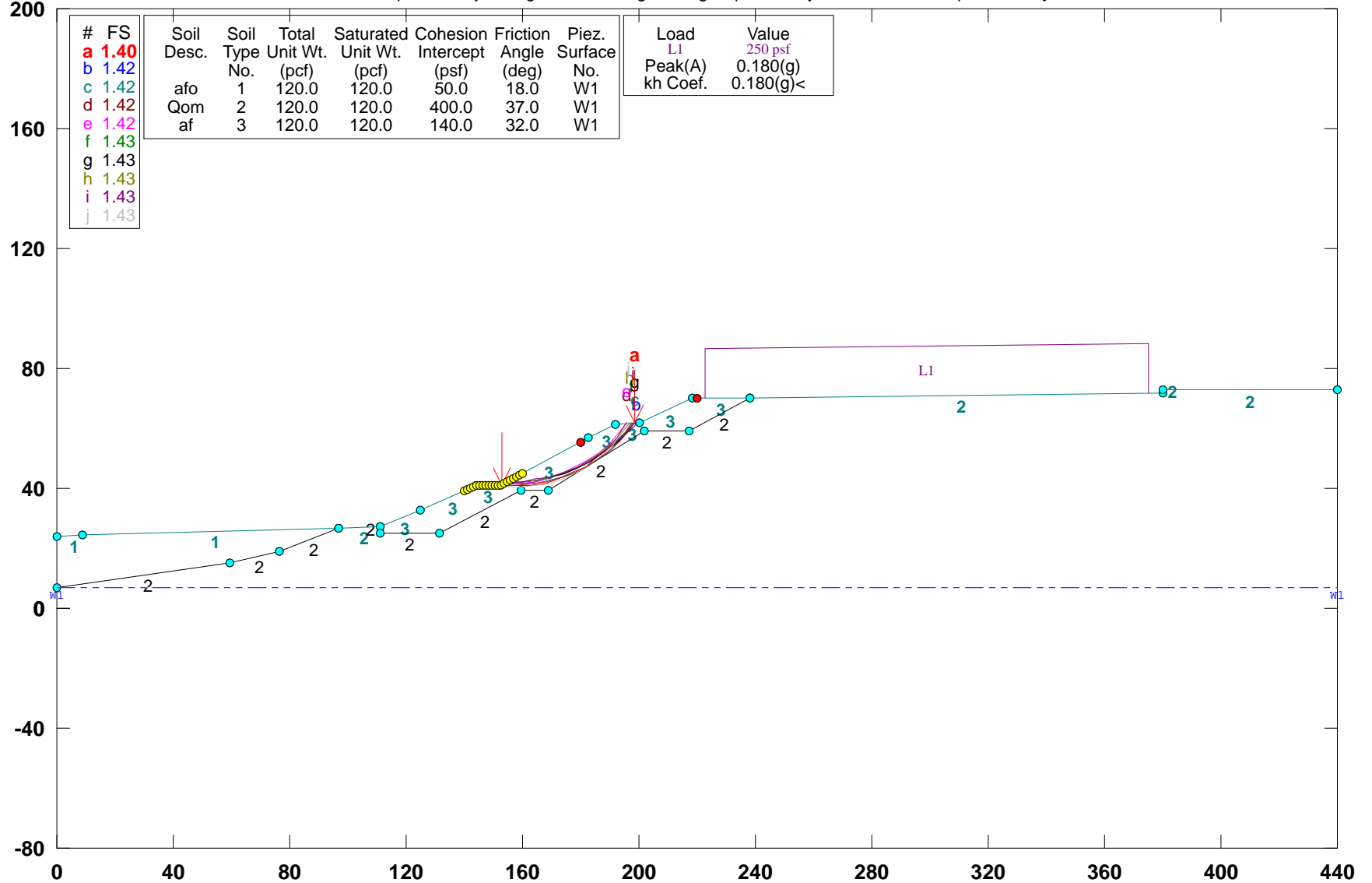

GSTABL7 v.2 FSmin=1.40  
Safety Factors Are Calculated By The Modified Bishop Method

\*\*\* GSTABL7 \*\*\*

\*\* GSTABL7 by Dr. Garry H. Gregory, Ph.D., P.E., D.GE \*\*

\*\* Original Version 1.0, January 1996; Current Ver. 2.005.3, Feb. 2013 \*\*  
(All Rights Reserved-Unauthorized Use Prohibited)

\*\*\*\*\*

SLOPE STABILITY ANALYSIS SYSTEM

Modified Bishop, Simplified Janbu, or GLE Method of Slices.  
(Includes Spencer & Morgenstern-Price Type Analysis)  
Including Pier/Pile, Reinforcement, Soil Nail, Tieback,  
Nonlinear Undrained Shear Strength, Curved Phi Envelope,  
Anisotropic Soil, Fiber-Reinforced Soil, Boundary Loads, Water  
Surfaces, Pseudo-Static & Newmark Earthquake, and Applied Forces.

\*\*\*\*\*

Analysis Run Date: 3/14/2019

Time of Run: 12:47PM

Run By: SHH

Input Data Filename: z:\2012\12091-01 Howard Industrial Partners - John S Gibson

Blvd\Engineering\Slope Stability\Sections\E-E'\exle.in

Output Filename: z:\2012\12091-01 Howard Industrial Partners - John S Gibson

Blvd\Engineering\Slope Stability\Sections\E-E'\exle.OUT

Unit System: English

Plotted Output Filename: z:\2012\12091-01 Howard Industrial Partners - John S Gibson

Blvd\Engineering\Slope Stability\Sections\E-E'\exle.PLT

PROBLEM DESCRIPTION: 12091-01 / John S. Gibson / Sec. E-E' /  
Mid Slope / Seismic / Keyway 20'

BOUNDARY COORDINATES

14 Top Boundaries

24 Total Boundaries

Boundary No.	X-Left (ft)	Y-Left (ft)	X-Right (ft)	Y-Right (ft)	Soil Type Below Bnd
1	0.00	24.00	9.00	24.50	1
2	9.00	24.50	96.60	26.50	1
3	96.60	26.50	111.30	27.00	2
4	111.30	27.00	125.00	32.80	3
5	125.00	32.80	144.30	41.00	3
6	144.30	41.00	152.40	41.00	3
7	152.40	41.00	182.60	56.70	3
8	182.60	56.70	191.70	61.60	3
9	191.70	61.60	200.00	61.70	3
10	200.00	61.70	218.30	70.00	3
11	218.30	70.00	238.30	70.20	3
12	238.30	70.20	379.90	72.00	2
13	379.90	72.00	379.91	73.00	2
14	379.91	73.00	440.00	73.00	2
15	0.00	7.00	59.20	15.10	2
16	59.20	15.10	76.30	19.10	2
17	76.30	19.10	96.60	26.50	2
18	111.30	27.00	111.31	25.00	2
19	111.31	25.00	131.30	25.00	2
20	131.30	25.00	159.70	39.40	2
21	159.70	39.40	169.10	39.40	2
22	169.10	39.40	201.80	59.30	2
23	201.80	59.30	217.30	59.30	2
24	217.30	59.30	238.30	70.20	2

Default Y-Origin = 0.00(ft)

Default X-Plus Value = 0.00(ft)

Default Y-Plus Value = 0.00(ft)

ISOTROPIC SOIL PARAMETERS

3 Type(s) of Soil

Soil Type No.	Total Unit Wt. (pcf)	Saturated Unit Wt. (pcf)	Cohesion (psf)	Friction Angle (deg)	Pore Pressure Param. (psf)	Pressure Constant	Piez. Surface No.
1	120.0	120.0	50.0	18.0	0.00	0.0	1
2	120.0	120.0	400.0	37.0	0.00	0.0	1
3	120.0	120.0	140.0	32.0	0.00	0.0	1

1 PIEZOMETRIC SURFACE(S) SPECIFIED

Unit Weight of Water = 62.40 (pcf)

Piezometric Surface No. 1 Specified by 2 Coordinate Points

Pore Pressure Inclination Factor = 0.50

Point X-Water Y-Water

No.	(ft)	(ft)
1	0.00	7.00
2	440.00	7.00

BOUNDARY LOAD(S)

Load No.	X-Left (ft)	X-Right (ft)	Intensity (psf)	Deflection (deg)
1	223.00	375.00	250.0	0.0

NOTE - Intensity Is Specified As A Uniformly Distributed Force Acting On A Horizontally Projected Surface.

Specified Peak Ground Acceleration Coefficient (A) = 0.180(g)

Specified Horizontal Earthquake Coefficient (kh) = 0.180(g)

Specified Vertical Earthquake Coefficient (kv) = 0.000(g)

Specified Seismic Pore-Pressure Factor = 0.000

A Critical Failure Surface Searching Method, Using A Random Technique For Generating Circular Surfaces, Has Been Specified.

5000 Trial Surfaces Have Been Generated.

250 Surface(s) Initiate(s) From Each Of 20 Points Equally Spaced

Along The Ground Surface Between X = 140.00(ft)

and X = 160.00(ft)

Each Surface Terminates Between X = 180.00(ft)

and X = 220.00(ft)

Unless Further Limitations Were Imposed, The Minimum Elevation

At Which A Surface Extends Is Y = 0.00(ft)

5.00(ft) Line Segments Define Each Trial Failure Surface.

Following Are Displayed The Ten Most Critical Of The Trial

Failure Surfaces Evaluated. They Are

Ordered - Most Critical First.

\* \* Safety Factors Are Calculated By The Modified Bishop Method \* \*

Total Number of Trial Surfaces Attempted = 5000

Number of Trial Surfaces With Valid FS = 5000

Statistical Data On All Valid FS Values:

FS Max = 4.494 FS Min = 1.402 FS Ave = 2.314

Standard Deviation = 0.403 Coefficient of Variation = 17.40 %

Failure Surface Specified By 12 Coordinate Points

Point No.	X-Surf (ft)	Y-Surf (ft)
1	152.632	41.120
2	157.630	40.997
3	162.618	41.341
4	167.552	42.150
5	172.389	43.417
6	177.086	45.132
7	181.602	47.278
8	185.897	49.837
9	189.935	52.786
10	193.678	56.101
11	197.096	59.751
12	198.592	61.683

Circle Center At X = 156.491 ; Y = 94.139 ; and Radius = 53.159

Factor of Safety \*\*\* = 1.402 \*\*\*

Slice No.	Width (ft)	Weight (lbs)	Water Force (lbs)		Tie Force Norm (lbs)	Tie Force Tan (lbs)	Earthquake Force (lbs)		Surcharge Load (lbs)
			Top	Bot			Hor	Ver	
1	5.0	816.5	0.0	0.0	0.0	0.0	147.0	0.0	0.0
2	5.0	2302.6	0.0	0.0	0.0	0.0	414.5	0.0	0.0
3	4.9	3463.2	0.0	0.0	0.0	0.0	623.4	0.0	0.0
4	4.8	4266.3	0.0	0.0	0.0	0.0	767.9	0.0	0.0
5	4.7	4699.6	0.0	0.0	0.0	0.0	845.9	0.0	0.0
6	4.5	4770.3	0.0	0.0	0.0	0.0	858.7	0.0	0.0
7	1.0	1061.8	0.0	0.0	0.0	0.0	191.1	0.0	0.0
8	3.3	3455.7	0.0	0.0	0.0	0.0	622.0	0.0	0.0
9	4.0	3997.4	0.0	0.0	0.0	0.0	719.5	0.0	0.0
10	1.8	1600.8	0.0	0.0	0.0	0.0	288.1	0.0	0.0
11	2.0	1516.4	0.0	0.0	0.0	0.0	272.9	0.0	0.0
12	3.4	1525.0	0.0	0.0	0.0	0.0	274.5	0.0	0.0
13	1.5	171.8	0.0	0.0	0.0	0.0	30.9	0.0	0.0

## Failure Surface Specified By 12 Coordinate Points

Point No.	X-Surf (ft)	Y-Surf (ft)
1	153.684	41.668
2	158.682	41.802
3	163.652	42.356
4	168.556	43.327
5	173.362	44.707
6	178.035	46.487
7	182.541	48.654
8	186.848	51.193
9	190.927	54.085
10	194.747	57.310
11	198.283	60.846
12	198.994	61.688

Circle Center At X = 154.630 ; Y = 100.810 ; and Radius = 59.150  
Factor of Safety  
\*\*\* 1.416 \*\*\*

## Failure Surface Specified By 12 Coordinate Points

Point No.	X-Surf (ft)	Y-Surf (ft)
1	153.684	41.668
2	158.678	41.412
3	163.671	41.665
4	168.613	42.425
5	173.452	43.683
6	178.138	45.428
7	182.622	47.640
8	186.858	50.296
9	190.801	53.370
10	194.412	56.829
11	197.652	60.638
12	198.370	61.680

Circle Center At X = 158.719 ; Y = 90.319 ; and Radius = 48.912  
Factor of Safety  
\*\*\* 1.416 \*\*\*

## Failure Surface Specified By 12 Coordinate Points

Point No.	X-Surf (ft)	Y-Surf (ft)
1	152.632	41.120
2	157.617	40.740
3	162.613	40.932
4	167.555	41.692
5	172.378	43.011
6	177.019	44.871
7	181.417	47.249
8	185.516	50.114
9	189.260	53.427
10	192.603	57.145
11	195.499	61.221
12	195.734	61.649

Circle Center At X = 158.456 ; Y = 84.406 ; and Radius = 43.676  
Factor of Safety  
\*\*\* 1.416 \*\*\*

## Failure Surface Specified By 11 Coordinate Points

Point No.	X-Surf (ft)	Y-Surf (ft)
1	153.684	41.668
2	158.684	41.747
3	163.651	42.316
4	168.539	43.368
5	173.300	44.894
6	177.889	46.880
7	182.262	49.305
8	186.376	52.147
9	190.191	55.378
10	193.672	58.967
11	195.806	61.649

Circle Center At X = 155.375 ; Y = 92.624 ; and Radius = 50.984  
Factor of Safety

\*\*\* 1.423 \*\*\*

## Failure Surface Specified By 11 Coordinate Points

Point No.	X-Surf (ft)	Y-Surf (ft)
1	154.737	42.215
2	159.736	42.157
3	164.717	42.594
4	169.630	43.523
5	174.427	44.933
6	179.061	46.811
7	183.486	49.139
8	187.659	51.893
9	191.539	55.047
10	195.087	58.570
11	197.647	61.672

Circle Center At X = 157.820 ; Y = 92.562 ; and Radius = 50.441  
Factor of Safety  
\*\*\* 1.425 \*\*\*

## Failure Surface Specified By 11 Coordinate Points

Point No.	X-Surf (ft)	Y-Surf (ft)
1	154.737	42.215
2	159.737	42.265
3	164.711	42.767
4	169.620	43.718
5	174.423	45.108
6	179.080	46.928
7	183.553	49.162
8	187.806	51.792
9	191.803	54.795
10	195.512	58.148
11	198.775	61.685

Circle Center At X = 156.686 ; Y = 97.369 ; and Radius = 55.188  
Factor of Safety  
\*\*\* 1.426 \*\*\*

## Failure Surface Specified By 11 Coordinate Points

Point No.	X-Surf (ft)	Y-Surf (ft)
1	154.737	42.215
2	159.737	42.239
3	164.710	42.751
4	169.610	43.746
5	174.390	45.214
6	179.003	47.143
7	183.406	49.512
8	187.556	52.300
9	191.415	55.480
10	194.944	59.022
11	197.108	61.665

Circle Center At X = 156.993 ; Y = 93.315 ; and Radius = 51.150  
Factor of Safety  
\*\*\* 1.427 \*\*\*

## Failure Surface Specified By 11 Coordinate Points

Point No.	X-Surf (ft)	Y-Surf (ft)
1	154.737	42.215
2	159.735	42.348
3	164.702	42.925
4	169.597	43.942
5	174.383	45.391
6	179.020	47.259
7	183.473	49.533
8	187.706	52.194
9	191.686	55.221
10	195.380	58.591
11	198.213	61.678

Circle Center At X = 155.743 ; Y = 98.341 ; and Radius = 56.135  
Factor of Safety  
\*\*\* 1.428 \*\*\*

## Failure Surface Specified By 12 Coordinate Points



Point No.	X-Surf (ft)	Y-Surf (ft)
1	149.474	41.000
2	154.435	40.381
3	159.435	40.307
4	164.412	40.780
5	169.308	41.794
6	174.064	43.337
7	178.624	45.389
8	182.931	47.928
9	186.936	50.922
10	190.589	54.335
11	193.848	58.127
12	196.264	61.655

Circle Center At X = 157.616 ; Y = 85.881 ; and Radius = 45.614  
Factor of Safety  
\*\*\* 1.429 \*\*\*  
\*\*\*\* END OF GSTABL7 OUTPUT \*\*\*\*

# 12091-01 / John S. Gibson / Sec. F-F' MSE Wall "D" / Static

z:\2012\12091-01 howard industrial partners - john s gibson blvd\engineering\slope stability\sections\l-f'\fxsx.pl2 Run By: LGC Geotechnical 3/14/2019 08:41AM

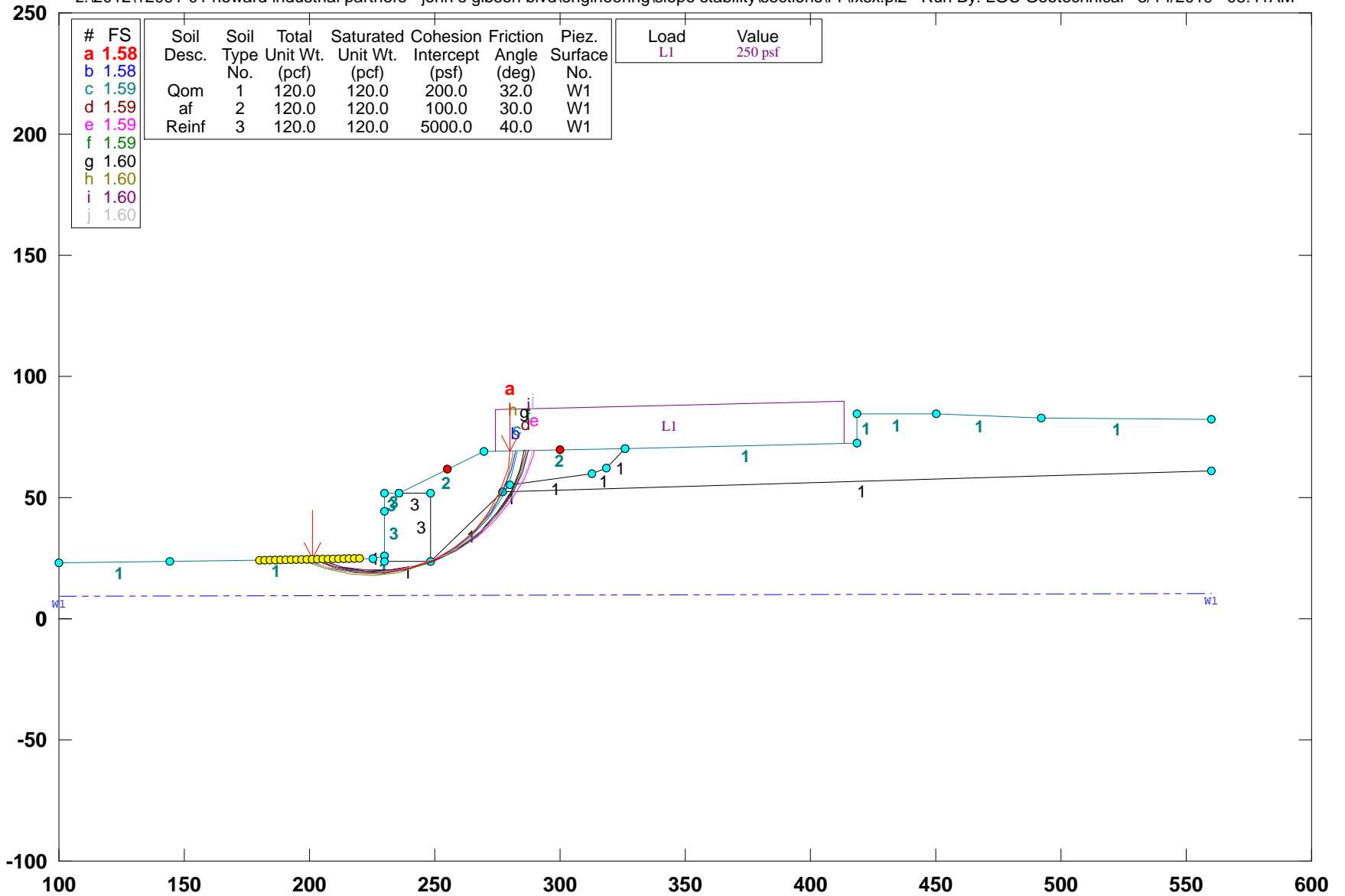

GSTABL7 v.2 FSmin=1.58  
 Safety Factors Are Calculated By The Modified Bishop Method

\*\*\* GSTABL7 \*\*\*

\*\* GSTABL7 by Dr. Garry H. Gregory, Ph.D., P.E., D.GE \*\*

\*\* Original Version 1.0, January 1996; Current Ver. 2.005.3, Feb. 2013 \*\*  
(All Rights Reserved-Unauthorized Use Prohibited)

\*\*\*\*\*

SLOPE STABILITY ANALYSIS SYSTEM

Modified Bishop, Simplified Janbu, or GLE Method of Slices.

(Includes Spencer & Morgenstern-Price Type Analysis)

Including Pier/Pile, Reinforcement, Soil Nail, Tieback,

Nonlinear Undrained Shear Strength, Curved Phi Envelope,

Anisotropic Soil, Fiber-Reinforced Soil, Boundary Loads, Water

Surfaces, Pseudo-Static & Newmark Earthquake, and Applied Forces.

\*\*\*\*\*

Analysis Run Date: 3/14/2019

Time of Run: 08:41AM

Run By: LGC Geotechnical

Input Data Filename: Z:\2012\12091-01 Howard Industrial Partners - John S Gibson

Blvd\Engineering\Slope Stability\Sections\F-F'\fxsx.in

Output Filename: Z:\2012\12091-01 Howard Industrial Partners - John S Gibson

Blvd\Engineering\Slope Stability\Sections\F-F'\fxsx.OUT

Unit System: English

Plotted Output Filename: Z:\2012\12091-01 Howard Industrial Partners - John S Gibson

Blvd\Engineering\Slope Stability\Sections\F-F'\fxsx.PLT

PROBLEM DESCRIPTION: 12091-01 / John S. Gibson / Sec. F-F'

MSE Wall "D" / Static

BOUNDARY COORDINATES

13 Top Boundaries

23 Total Boundaries

Boundary No.	X-Left (ft)	Y-Left (ft)	X-Right (ft)	Y-Right (ft)	Soil Type Below Bnd
1	100.00	23.00	144.10	23.40	1
2	144.10	23.40	225.50	25.00	1
3	225.50	25.00	230.20	25.90	1
4	230.20	25.90	230.21	44.30	3
5	230.21	44.30	230.22	52.00	3
6	230.22	52.00	235.60	52.00	3
7	235.60	52.00	269.50	69.00	2
8	269.50	69.00	325.70	70.40	2
9	325.70	70.40	418.50	72.60	1
10	418.50	72.60	418.51	84.70	1
11	418.51	84.70	450.00	84.80	1
12	450.00	84.80	492.10	82.90	1
13	492.10	82.90	560.00	82.00	1
14	235.60	52.00	248.40	52.00	3
15	248.40	52.00	248.41	23.90	3
16	230.20	25.90	230.21	23.90	1
17	230.21	23.90	248.41	23.90	1
18	248.41	23.90	276.90	52.10	1
19	276.90	52.10	280.10	55.20	1
20	280.10	55.20	312.70	60.00	1
21	312.70	60.00	318.50	62.40	1
22	318.50	62.40	325.70	70.40	1
23	276.90	52.10	560.00	60.80	1

Default Y-Origin = 0.00(ft)

Default X-Plus Value = 0.00(ft)

Default Y-Plus Value = 0.00(ft)

ISOTROPIC SOIL PARAMETERS

3 Type(s) of Soil

Soil Type	Total Unit Wt. (pcf)	Saturated Unit Wt. (pcf)	Cohesion (psf)	Friction Angle (deg)	Pore Pressure Param. (psf)	Pressure Constant (psf)	Piez. Surface No.
1	120.0	120.0	200.0	32.0	0.00	0.0	1
2	120.0	120.0	100.0	30.0	0.00	0.0	1
3	120.0	120.0	5000.0	40.0	0.00	0.0	1

1 PIEZOMETRIC SURFACE(S) SPECIFIED

Unit Weight of Water = 62.40 (pcf)

Piezometric Surface No. 1 Specified by 2 Coordinate Points

Pore Pressure Inclination Factor = 0.50

Point No.	X-Water (ft)	Y-Water (ft)
1		
2		

1	100.00	9.00
2	560.00	10.20

BOUNDARY LOAD(S)

1 Load(s) Specified

Load No.	X-Left (ft)	X-Right (ft)	Intensity (psf)	Deflection (deg)
1	274.50	413.60	250.0	0.0

NOTE - Intensity Is Specified As A Uniformly Distributed

Force Acting On A Horizontally Projected Surface.

A Critical Failure Surface Searching Method, Using A Random

Technique For Generating Circular Surfaces, Has Been Specified.

5000 Trial Surfaces Have Been Generated.

250 Surface(s) Initiate(s) From Each Of 20 Points Equally Spaced

Along The Ground Surface Between X = 180.00(ft)

and X = 220.00(ft)

Each Surface Terminates Between X = 255.00(ft)

and X = 300.00(ft)

Unless Further Limitations Were Imposed, The Minimum Elevation

At Which A Surface Extends Is Y = 0.00(ft)

10.00(ft) Line Segments Define Each Trial Failure Surface.

Following Are Displayed The Ten Most Critical Of The Trial

Failure Surfaces Evaluated. They Are

Ordered - Most Critical First.

\* \* Safety Factors Are Calculated By The Modified Bishop Method \* \*

Total Number of Trial Surfaces Attempted = 5000

Number of Trial Surfaces With Valid FS = 5000

Statistical Data On All Valid FS Values:

FS Max = 4.475 FS Min = 1.579 FS Ave = 2.031

Standard Deviation = 0.314 Coefficient of Variation = 15.45 %

Failure Surface Specified By 12 Coordinate Points

Point No.	X-Surf (ft)	Y-Surf (ft)
1	201.053	24.519
2	210.346	20.827
3	220.158	18.895
4	230.157	18.788
5	240.008	20.510
6	249.378	24.003
7	257.952	29.149
8	265.442	35.775
9	271.595	43.658
10	276.204	52.532
11	279.115	62.099
12	279.917	69.259

Circle Center At X = 225.735 ; Y = 72.889 ; and Radius = 54.303

Factor of Safety \*\*\* = 1.579 \*\*\*

Slice No.	Width (ft)	Weight (lbs)	Water Force (lbs)		Tie Force (lbs)		Earthquake Force (lbs)		Surcharge Load (lbs)
			Top	Bot	Norm	Tan	Hor	Ver	
1	9.3	2160.6	0.0	0.0	0.0	0.0	0.0	0.0	0.0
2	9.8	5813.1	0.0	0.0	0.0	0.0	0.0	0.0	0.0
3	5.3	3898.2	0.0	0.0	0.0	0.0	0.0	0.0	0.0
4	4.7	3706.7	0.0	0.0	0.0	0.0	0.0	0.0	0.0
5	0.0	36.5	0.0	0.0	0.0	0.0	0.0	0.0	0.0
6	0.0	19.5	0.0	0.0	0.0	0.0	0.0	0.0	0.0
7	0.0	35.3	0.0	0.0	0.0	0.0	0.0	0.0	0.0
8	5.4	21130.7	0.0	0.0	0.0	0.0	0.0	0.0	0.0
9	4.4	17444.3	0.0	0.0	0.0	0.0	0.0	0.0	0.0
10	8.4	34482.0	0.0	0.0	0.0	0.0	0.0	0.0	0.0
11	0.0	42.1	0.0	0.0	0.0	0.0	0.0	0.0	0.0
12	1.0	4047.2	0.0	0.0	0.0	0.0	0.0	0.0	0.0
13	8.6	35480.3	0.0	0.0	0.0	0.0	0.0	0.0	0.0
14	7.5	29322.5	0.0	0.0	0.0	0.0	0.0	0.0	0.0
15	4.1	14417.6	0.0	0.0	0.0	0.0	0.0	0.0	0.0
16	2.1	6715.7	0.0	0.0	0.0	0.0	0.0	0.0	0.0
17	2.9	7889.7	0.0	0.0	0.0	0.0	0.0	0.0	0.0
18	0.5	1178.8	0.0	0.0	0.0	0.0	0.0	0.0	126.6

19	1.2	2554.9	0.0	0.0	0.	0.	0.0	0.0	299.5
20	2.9	4151.4	0.0	0.0	0.	0.	0.0	0.0	727.6
21	0.8	343.6	0.0	0.0	0.	0.	0.0	0.0	200.5

Failure Surface Specified By 12 Coordinate Points

Point No.	X-Surf (ft)	Y-Surf (ft)
1	201.053	24.519
2	210.436	21.062
3	220.278	19.292
4	230.278	19.265
5	240.130	20.981
6	249.532	24.387
7	258.196	29.380
8	265.858	35.807
9	272.282	43.470
10	277.273	52.136
11	280.676	61.538
12	282.028	69.312

Circle Center At X = 225.433 ; Y = 76.035 ; and Radius = 56.993  
 Factor of Safety  
 \*\*\* 1.580 \*\*\*

Failure Surface Specified By 13 Coordinate Points

Point No.	X-Surf (ft)	Y-Surf (ft)
1	198.947	24.478
2	208.275	20.873
3	218.079	18.901
4	228.075	18.619
5	237.974	20.036
6	247.489	23.110
7	256.346	27.752
8	264.288	33.829
9	271.085	41.164
10	276.540	49.545
11	280.496	58.729
12	282.838	68.451
13	282.896	69.334

Circle Center At X = 224.727 ; Y = 77.305 ; and Radius = 58.782  
 Factor of Safety  
 \*\*\* 1.589 \*\*\*

Failure Surface Specified By 13 Coordinate Points

Point No.	X-Surf (ft)	Y-Surf (ft)
1	201.053	24.519
2	210.480	21.183
3	220.324	19.423
4	230.323	19.288
5	240.211	20.779
6	249.725	23.858
7	258.612	28.443
8	266.635	34.412
9	273.582	41.605
10	279.266	49.832
11	283.538	58.874
12	286.283	68.490
13	286.390	69.421

Circle Center At X = 226.153 ; Y = 80.454 ; and Radius = 61.308  
 Factor of Safety  
 \*\*\* 1.590 \*\*\*

Failure Surface Specified By 13 Coordinate Points

Point No.	X-Surf (ft)	Y-Surf (ft)
1	201.053	24.519
2	210.567	21.440
3	220.438	19.838
4	230.437	19.752
5	240.334	21.184
6	249.900	24.099
7	258.912	28.432
8	267.164	34.082

9	274.463	40.917
10	280.641	48.780
11	285.555	57.490
12	289.091	66.843
13	289.656	69.502

Circle Center At X = 226.001 ; Y = 85.351 ; and Radius = 65.749  
 Factor of Safety  
 \*\*\* 1.593 \*\*\*

Failure Surface Specified By 13 Coordinate Points

Point No.	X-Surf (ft)	Y-Surf (ft)
1	201.053	24.519
2	210.493	21.221
3	220.340	19.478
4	230.339	19.334
5	240.232	20.794
6	249.763	23.820
7	258.686	28.334
8	266.771	34.219
9	273.810	41.323
10	279.619	49.462
11	284.049	58.427
12	286.986	67.986
13	287.187	69.441

Circle Center At X = 226.230 ; Y = 81.422 ; and Radius = 62.224  
 Factor of Safety  
 \*\*\* 1.593 \*\*\*

Failure Surface Specified By 12 Coordinate Points

Point No.	X-Surf (ft)	Y-Surf (ft)
1	203.158	24.561
2	212.649	21.411
3	222.530	19.874
4	232.529	19.994
5	242.371	21.766
6	251.784	25.141
7	260.509	30.028
8	268.305	36.290
9	274.958	43.756
10	280.284	52.220
11	284.136	61.448
12	285.994	69.411

Circle Center At X = 226.815 ; Y = 79.790 ; and Radius = 60.082  
 Factor of Safety  
 \*\*\* 1.595 \*\*\*

Failure Surface Specified By 13 Coordinate Points

Point No.	X-Surf (ft)	Y-Surf (ft)
1	196.842	24.437
2	206.097	20.649
3	215.863	18.496
4	225.852	18.041
5	235.773	19.298
6	245.334	22.228
7	254.255	26.747
8	262.274	32.721
9	269.156	39.977
10	274.699	48.300
11	278.741	57.447
12	281.162	67.149
13	281.320	69.294

Circle Center At X = 223.505 ; Y = 76.387 ; and Radius = 58.393  
 Factor of Safety  
 \*\*\* 1.595 \*\*\*

Failure Surface Specified By 12 Coordinate Points

Point No.	X-Surf (ft)	Y-Surf (ft)
1	203.158	24.561
2	212.661	21.449
3	222.544	19.918

4	232.543	20.010
5	242.396	21.721
6	251.840	25.007
7	260.628	29.780
8	268.525	35.914
9	275.324	43.248
10	280.844	51.586
11	284.939	60.709
12	287.254	69.442

Circle Center At X = 226.983 ; Y = 81.147 ; and Radius = 61.397

Factor of Safety

\*\*\* 1.596 \*\*\*

Failure Surface Specified By 13 Coordinate Points

Point No.	X-Surf (ft)	Y-Surf (ft)
1	196.842	24.437
2	206.312	21.224
3	216.149	19.428
4	226.144	19.088
5	236.080	20.212
6	245.746	22.774
7	254.935	26.721
8	263.448	31.967
9	271.104	38.400
10	277.739	45.882
11	283.209	54.253
12	287.399	63.333
13	289.208	69.491

Circle Center At X = 223.460 ; Y = 87.328 ; and Radius = 68.293

Factor of Safety

\*\*\* 1.597 \*\*\*

\*\*\*\* END OF GSTABL7 OUTPUT \*\*\*\*

# 12091-01 / John S. Gibson / Sec. F-F' MSE Wall "D" / Seismic

z:\2012\12091-01 howard industrial partners - john s gibson blvd\engineering\slope stability\sections\f-f'\fxsxe.pl2 Run By: LGC Geotechnical 3/14/2019 08:45AM

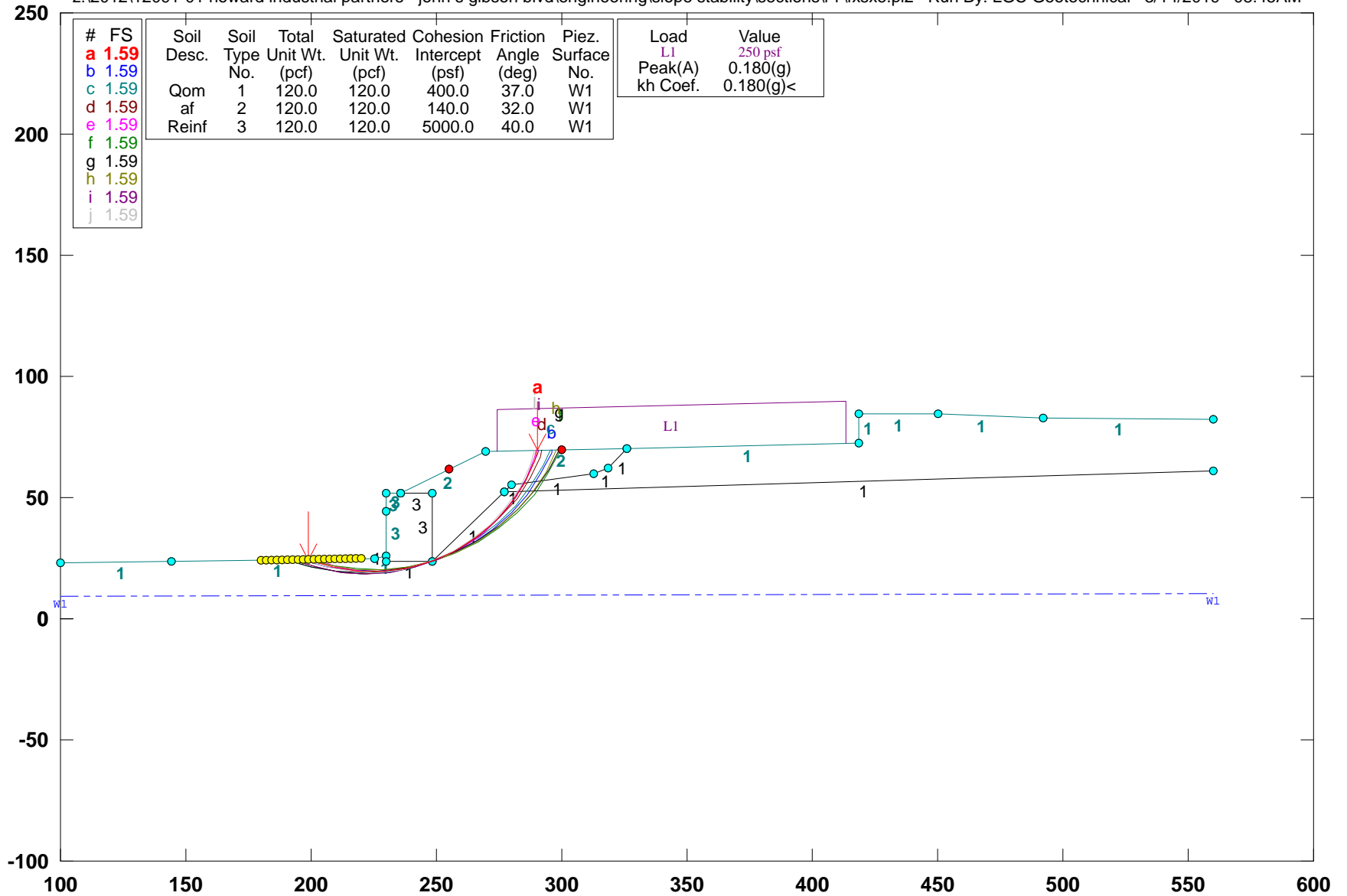

**GSTABL7 v.2 FSmin=1.59**  
**Safety Factors Are Calculated By The Modified Bishop Method**

\*\*\* GSTABL7 \*\*\*

\*\* GSTABL7 by Dr. Garry H. Gregory, Ph.D., P.E., D.GE \*\*

\*\* Original Version 1.0, January 1996; Current Ver. 2.005.3, Feb. 2013 \*\*  
(All Rights Reserved-Unauthorizd Use Prohibited)

\*\*\*\*\*

SLOPE STABILITY ANALYSIS SYSTEM

Modified Bishop, Simplified Janbu, or GLE Method of Slices.  
(Includes Spencer & Morgenstern-Price Type Analysis)  
Including Pier/Pile, Reinforcement, Soil Nail, Tieback,  
Nonlinear Undrained Shear Strength, Curved Phi Envelope,  
Anisotropic Soil, Fiber-Reinforced Soil, Boundary Loads, Water  
Surfaces, Pseudo-Static & Newmark Earthquake, and Applied Forces.

\*\*\*\*\*

Analysis Run Date: 3/14/2019

Time of Run: 08:45AM

Run By: LGC Geotechnical

Input Data Filename: Z:\2012\12091-01 Howard Industrial Partners - John S Gibson

Blvd\Engineering\Slope Stability\Sections\F-F'\fxsxe.in

Output Filename: Z:\2012\12091-01 Howard Industrial Partners - John S Gibson

Blvd\Engineering\Slope Stability\Sections\F-F'\fxsxe.OUT

Unit System: English

Plotted Output Filename: Z:\2012\12091-01 Howard Industrial Partners - John S Gibson

Blvd\Engineering\Slope Stability\Sections\F-F'\fxsxe.PLT

PROBLEM DESCRIPTION: 12091-01 / John S. Gibson / Sec. F-F'  
MSE Wall "D" / Seismic

BOUNDARY COORDINATES

13 Top Boundaries  
23 Total Boundaries

Boundary No.	X-Left (ft)	Y-Left (ft)	X-Right (ft)	Y-Right (ft)	Soil Type Below Bnd
1	100.00	23.00	144.10	23.40	1
2	144.10	23.40	225.50	25.00	1
3	225.50	25.00	230.20	25.90	1
4	230.20	25.90	230.21	44.30	3
5	230.21	44.30	230.22	52.00	3
6	230.22	52.00	235.60	52.00	3
7	235.60	52.00	269.50	69.00	2
8	269.50	69.00	325.70	70.40	2
9	325.70	70.40	418.50	72.60	1
10	418.50	72.60	418.51	84.70	1
11	418.51	84.70	450.00	84.80	1
12	450.00	84.80	492.10	82.90	1
13	492.10	82.90	560.00	82.00	1
14	235.60	52.00	248.40	52.00	3
15	248.40	52.00	248.41	23.90	3
16	230.20	25.90	230.21	23.90	1
17	230.21	23.90	248.41	23.90	1
18	248.41	23.90	276.90	52.10	1
19	276.90	52.10	280.10	55.20	1
20	280.10	55.20	312.70	60.00	1
21	312.70	60.00	318.50	62.40	1
22	318.50	62.40	325.70	70.40	1
23	276.90	52.10	560.00	60.80	1

Default Y-Origin = 0.00(ft)

Default X-Plus Value = 0.00(ft)

Default Y-Plus Value = 0.00(ft)

ISOTROPIC SOIL PARAMETERS

3 Type(s) of Soil

Soil Type No.	Total Unit Wt. (pcf)	Saturated Unit Wt. (pcf)	Cohesion (psf)	Friction Angle (deg)	Pore Pressure Param. (psf)	Pressure Constant	Piez. Surface
1	120.0	120.0	400.0	37.0	0.00	0.0	1
2	120.0	120.0	140.0	32.0	0.00	0.0	1
3	120.0	120.0	5000.0	40.0	0.00	0.0	1

1 PIEZOMETRIC SURFACE(S) SPECIFIED

Unit Weight of Water = 62.40 (pcf)

Piezometric Surface No. 1 Specified by 2 Coordinate Points

Pore Pressure Inclination Factor = 0.50

Point No.	X-Water (ft)	Y-Water (ft)
1		
2		

1	100.00	9.00
2	560.00	10.20

BOUNDARY LOAD(S)

1 Load(s) Specified

Load No.	X-Left (ft)	X-Right (ft)	Intensity (psf)	Deflection (deg)
1	274.50	413.60	250.0	0.0

NOTE - Intensity Is Specified As A Uniformly Distributed Force Acting On A Horizontally Projected Surface.

Specified Peak Ground Acceleration Coefficient (A) = 0.180(g)

Specified Horizontal Earthquake Coefficient (kh) = 0.180(g)

Specified Vertical Earthquake Coefficient (kv) = 0.000(g)

Specified Seismic Pore-Pressure Factor = 0.000

A Critical Failure Surface Searching Method, Using A Random Technique For Generating Circular Surfaces, Has Been Specified.

5000 Trial Surfaces Have Been Generated.

250 Surface(s) Initiate(s) From Each Of 20 Points Equally Spaced

Along The Ground Surface Between X = 180.00(ft)

and X = 220.00(ft)

Each Surface Terminates Between X = 255.00(ft)

and X = 300.00(ft)

Unless Further Limitations Were Imposed, The Minimum Elevation

At Which A Surface Extends Is Y = 0.00(ft)

10.00(ft) Line Segments Define Each Trial Failure Surface.

Following Are Displayed The Ten Most Critical Of The Trial

Failure Surfaces Evaluated. They Are

Ordered - Most Critical First.

\* \* Safety Factors Are Calculated By The Modified Bishop Method \* \*

Total Number of Trial Surfaces Attempted = 5000

Number of Trial Surfaces With Valid FS = 5000

Statistical Data On All Valid FS Values:

FS Max = 3.855 FS Min = 1.586 FS Ave = 1.932

Standard Deviation = 0.226 Coefficient of Variation = 11.68 %

Failure Surface Specified By 13 Coordinate Points

Point No.	X-Surf (ft)	Y-Surf (ft)
1	198.947	24.478
2	208.485	21.474
3	218.358	19.880
4	228.357	19.731
5	238.272	21.029
6	247.895	23.748
7	257.025	27.829
8	265.468	33.188
9	273.047	39.711
10	279.604	47.261
11	285.000	55.680
12	289.121	64.792
13	290.481	69.523

Circle Center At X = 224.384 ; Y = 88.590 ; and Radius = 68.974

Factor of Safety = 1.586

\*\*\* 1.586 \*\*\*

Slice No.	Width (ft)	Weight (lbs)	Water Force (lbs)		Tie Force (lbs)		Earthquake Force (lbs)		Surcharge Load (lbs)	
			Top	Bot	Norm	Tan	Hor	Ver		
1	9.5	1826.6	0.0	0.0	0.0	0.0	0.0	328.8	0.0	0.0
2	9.9	4840.0	0.0	0.0	0.0	0.0	0.0	871.2	0.0	0.0
3	7.1	4373.5	0.0	0.0	0.0	0.0	0.0	787.2	0.0	0.0
4	2.9	1892.6	0.0	0.0	0.0	0.0	0.0	340.7	0.0	0.0
5	1.8	1298.9	0.0	0.0	0.0	0.0	0.0	233.8	0.0	0.0
6	0.0	18.1	0.0	0.0	0.0	0.0	0.0	3.3	0.0	0.0
7	0.0	33.8	0.0	0.0	0.0	0.0	0.0	6.1	0.0	0.0
8	5.4	20447.9	0.0	0.0	0.0	0.0	0.0	3680.6	0.0	0.0
9	2.7	10201.2	0.0	0.0	0.0	0.0	0.0	1836.2	0.0	0.0
10	9.6	38529.6	0.0	0.0	0.0	0.0	0.0	6935.3	0.0	0.0
11	0.3	1407.8	0.0	0.0	0.0	0.0	0.0	253.4	0.0	0.0
12	0.2	677.1	0.0	0.0	0.0	0.0	0.0	121.9	0.0	0.0
13	0.0	41.2	0.0	0.0	0.0	0.0	0.0	7.4	0.0	0.0

14	0.1	592.1	0.0	0.0	0.	0.	106.6	0.0	0.0
15	8.5	35259.3	0.0	0.0	0.	0.	6346.7	0.0	0.0
16	8.4	34805.2	0.0	0.0	0.	0.	6264.9	0.0	0.0
17	4.0	15999.8	0.0	0.0	0.	0.	2880.0	0.0	0.0
18	3.5	13136.2	0.0	0.0	0.	0.	2364.5	0.0	0.0
19	1.5	4978.7	0.0	0.0	0.	0.	896.2	0.0	0.0
20	2.4	7600.0	0.0	0.0	0.	0.	1368.0	0.0	600.0
21	2.7	7629.4	0.0	0.0	0.	0.	1373.3	0.0	676.0
22	0.5	1286.5	0.0	0.0	0.	0.	231.6	0.0	124.0
23	2.7	6250.9	0.0	0.0	0.	0.	1125.2	0.0	680.4
24	2.2	4019.3	0.0	0.0	0.	0.	723.5	0.0	544.5
25	0.1	190.3	0.0	0.0	0.	0.	34.3	0.0	29.2
26	4.0	4360.8	0.0	0.0	0.	0.	784.9	0.0	1001.2
27	1.4	383.0	0.0	0.0	0.	0.	68.9	0.0	339.8

Failure Surface Specified By 14 Coordinate Points

Point No.	X-Surf (ft)	Y-Surf (ft)
-----------	-------------	-------------

1	196.842	24.437
2	206.434	21.608
3	216.309	20.032
4	226.304	19.733
5	236.256	20.717
6	245.999	22.968
7	255.374	26.448
8	264.226	31.100
9	272.409	36.848
10	279.789	43.597
11	286.243	51.235
12	291.666	59.637
13	295.968	68.664
14	296.296	69.668

Circle Center At X = 223.633 ; Y = 97.486 ; and Radius = 77.807

Factor of Safety  
\*\*\* 1.588 \*\*\*

Failure Surface Specified By 14 Coordinate Points

Point No.	X-Surf (ft)	Y-Surf (ft)
-----------	-------------	-------------

1	190.526	24.313
2	200.035	21.216
3	209.852	19.315
4	219.829	18.638
5	229.814	19.195
6	239.654	20.979
7	249.198	23.961
8	258.303	28.098
9	266.828	33.324
10	274.645	39.561
11	281.633	46.714
12	287.687	54.674
13	292.713	63.319
14	295.411	69.645

Circle Center At X = 220.313 ; Y = 99.398 ; and Radius = 80.777

Factor of Safety  
\*\*\* 1.589 \*\*\*

Failure Surface Specified By 14 Coordinate Points

Point No.	X-Surf (ft)	Y-Surf (ft)
-----------	-------------	-------------

1	192.632	24.354
2	202.102	21.144
3	211.916	19.222
4	221.898	18.622
5	231.871	19.355
6	241.658	21.408
7	251.085	24.745
8	259.985	29.305
9	268.198	35.009
10	275.581	41.754
11	282.001	49.421
12	287.344	57.874
13	291.515	66.963

14 292.312 69.568  
Circle Center At X = 221.398 ; Y = 93.421 ; and Radius = 74.818

Factor of Safety

\*\*\* 1.589 \*\*\*

Failure Surface Specified By 13 Coordinate Points

Point No.	X-Surf (ft)	Y-Surf (ft)
-----------	-------------	-------------

1	201.053	24.519
2	210.567	21.440
3	220.438	19.838
4	230.437	19.752
5	240.334	21.184
6	249.900	24.099
7	258.912	28.432
8	267.164	34.082
9	274.463	40.917
10	280.641	48.780
11	285.555	57.490
12	289.091	66.843
13	289.656	69.502

Circle Center At X = 226.001 ; Y = 85.351 ; and Radius = 65.749

Factor of Safety  
\*\*\* 1.590 \*\*\*

Failure Surface Specified By 14 Coordinate Points

Point No.	X-Surf (ft)	Y-Surf (ft)
-----------	-------------	-------------

1	198.947	24.478
2	208.611	21.907
3	218.517	20.536
4	228.516	20.387
5	238.458	21.461
6	248.194	23.743
7	257.578	27.199
8	266.469	31.776
9	274.734	37.405
10	282.248	44.003
11	288.900	51.471
12	294.588	59.695
13	299.228	68.553
14	299.679	69.752

Circle Center At X = 224.738 ; Y = 101.793 ; and Radius = 81.503

Factor of Safety  
\*\*\* 1.591 \*\*\*

Failure Surface Specified By 14 Coordinate Points

Point No.	X-Surf (ft)	Y-Surf (ft)
-----------	-------------	-------------

1	190.526	24.313
2	200.098	21.416
3	209.939	19.644
4	219.920	19.020
5	229.906	19.553
6	239.763	21.234
7	249.361	24.043
8	258.570	27.941
9	267.267	32.876
10	275.337	38.782
11	282.671	45.580
12	289.171	53.179
13	294.750	61.478
14	299.009	69.735

Circle Center At X = 220.316 ; Y = 105.421 ; and Radius = 86.406

Factor of Safety  
\*\*\* 1.591 \*\*\*

Failure Surface Specified By 14 Coordinate Points

Point No.	X-Surf (ft)	Y-Surf (ft)
-----------	-------------	-------------

1	198.947	24.478
2	208.576	21.777
3	218.469	20.320
4	228.467	20.131



5	238.408	21.213
6	248.132	23.549
7	257.480	27.101
8	266.301	31.812
9	274.452	37.604
10	281.802	44.385
11	288.232	52.044
12	293.637	60.457
13	297.929	69.489
14	298.001	69.710

Circle Center At X = 224.950 ; Y = 98.610 ; and Radius = 78.560

Factor of Safety

\*\*\* 1.592 \*\*\*

Failure Surface Specified By 14 Coordinate Points

Point No.	X-Surf (ft)	Y-Surf (ft)
1	192.632	24.354
2	202.071	21.053
3	211.873	19.072
4	221.853	18.449
5	231.826	19.195
6	241.602	21.296
7	251.000	24.713
8	259.843	29.382
9	267.966	35.215
10	275.215	42.104
11	281.455	49.918
12	286.570	58.511
13	290.462	67.722
14	290.950	69.534

Circle Center At X = 221.405 ; Y = 91.306 ; and Radius = 72.873

Factor of Safety

\*\*\* 1.592 \*\*\*

Failure Surface Specified By 13 Coordinate Points

Point No.	X-Surf (ft)	Y-Surf (ft)
1	196.842	24.437
2	206.312	21.224
3	216.149	19.428
4	226.144	19.088
5	236.080	20.212
6	245.746	22.774
7	254.935	26.721
8	263.448	31.967
9	271.104	38.400
10	277.739	45.882
11	283.209	54.253
12	287.399	63.333
13	289.208	69.491

Circle Center At X = 223.460 ; Y = 87.328 ; and Radius = 68.293

Factor of Safety

\*\*\* 1.593 \*\*\*

\*\*\*\* END OF GSTABL7 OUTPUT \*\*\*\*

# 12091-01 / John S. Gibson / Sec. F-F' MSE Wall "D" / Static / Along Bedding

z:\2012\12091-01 howard industrial partners - john s gibson blvd\engineering\slope stability\sections\l-f'\vxsx2.pl2 Run By: SHH 3/14/2019 01:22PM

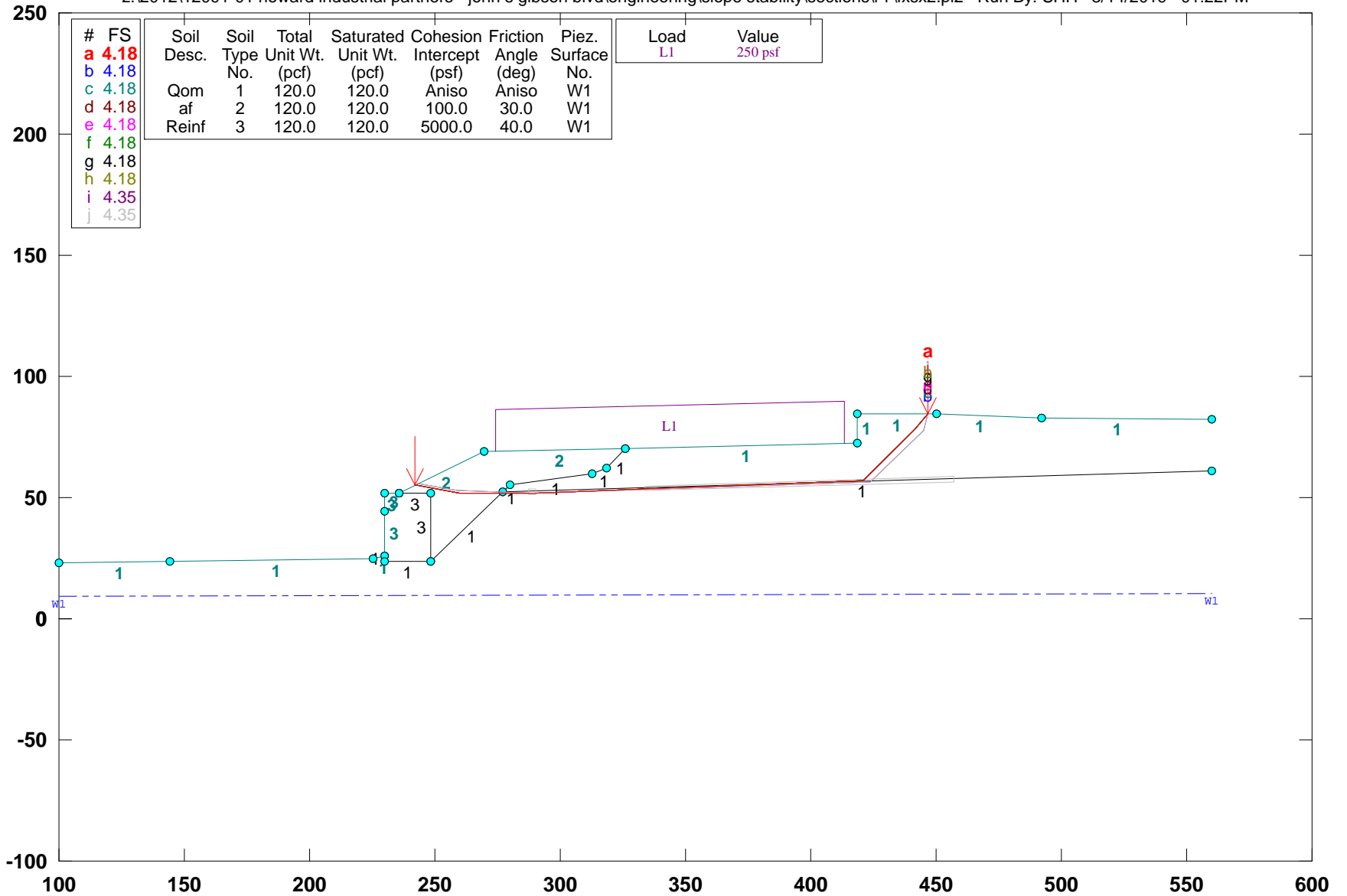

GSTABL7 v.2 FSmin=4.18

Safety Factors Are Calculated By The Simplified Janbu Method for the case of c & phi both > 0

\*\*\* GSTABL7 \*\*\*

\*\* GSTABL7 by Dr. Garry H. Gregory, Ph.D., P.E., D.GE \*\*

\*\* Original Version 1.0, January 1996; Current Ver. 2.005.3, Feb. 2013 \*\*  
 (All Rights Reserved-Unauthorized Use Prohibited)

SLOPE STABILITY ANALYSIS SYSTEM

Modified Bishop, Simplified Janbu, or GLE Method of Slices.  
 (Includes Spencer & Morgenstern-Price Type Analysis)  
 Including Pier/Pile, Reinforcement, Soil Nail, Tieback,  
 Nonlinear Undrained Shear Strength, Curved Phi Envelope,  
 Anisotropic Soil, Fiber-Reinforced Soil, Boundary Loads, Water  
 Surfaces, Pseudo-Static & Newmark Earthquake, and Applied Forces.

Analysis Run Date: 3/14/2019

Time of Run: 01:22PM

Run By: SHH

Input Data Filename: Z:\2012\12091-01 Howard Industrial Partners - John S Gibson

Blvd\Engineering\Slope Stability\Sections\F-F'\fxsx2.in

Output Filename: Z:\2012\12091-01 Howard Industrial Partners - John S Gibson

Blvd\Engineering\Slope Stability\Sections\F-F'\fxsx2.OUT

Unit System: English

Plotted Output Filename: Z:\2012\12091-01 Howard Industrial Partners - John S Gibson

Blvd\Engineering\Slope Stability\Sections\F-F'\fxsx2.PLT

PROBLEM DESCRIPTION: 12091-01 / John S. Gibson / Sec. F-F'  
 MSE Wall "D" / Static / Along Bedding

BOUNDARY COORDINATES

13 Top Boundaries

23 Total Boundaries

Boundary No.	X-Left (ft)	Y-Left (ft)	X-Right (ft)	Y-Right (ft)	Soil Type Below Bnd
1	100.00	23.00	144.10	23.40	1
2	144.10	23.40	225.50	25.00	1
3	225.50	25.00	230.20	25.90	1
4	230.20	25.90	230.21	44.30	3
5	230.21	44.30	230.22	52.00	3
6	230.22	52.00	235.60	52.00	3
7	235.60	52.00	269.50	69.00	2
8	269.50	69.00	325.70	70.40	2
9	325.70	70.40	418.50	72.60	1
10	418.50	72.60	418.51	84.70	1
11	418.51	84.70	450.00	84.80	1
12	450.00	84.80	492.10	82.90	1
13	492.10	82.90	560.00	82.00	1
14	235.60	52.00	248.40	52.00	3
15	248.40	52.00	248.41	23.90	3
16	230.20	25.90	230.21	23.90	1
17	230.21	23.90	248.41	23.90	1
18	248.41	23.90	276.90	52.10	1
19	276.90	52.10	280.10	55.20	1
20	280.10	55.20	312.70	60.00	1
21	312.70	60.00	318.50	62.40	1
22	318.50	62.40	325.70	70.40	1
23	276.90	52.10	560.00	60.80	1

Default Y-Origin = 0.00(ft)  
 Default X-Plus Value = 0.00(ft)  
 Default Y-Plus Value = 0.00(ft)

ISOTROPIC SOIL PARAMETERS

3 Type(s) of Soil

Soil Type No.	Total Unit Wt. (pcf)	Saturated Unit Wt. (pcf)	Cohesion (psf)	Friction Angle (deg)	Pore Pressure Param. (psf)	Pressure Constant (psf)	Piez. Surface No.
1	120.0	120.0	200.0	32.0	0.00	0.0	1
2	120.0	120.0	100.0	30.0	0.00	0.0	1
3	120.0	120.0	5000.0	40.0	0.00	0.0	1

ANISOTROPIC STRENGTH PARAMETERS

1 soil type(s)

Soil Type 1 Is Anisotropic  
 Number Of Direction Ranges Specified = 3  
 Direction Counter-clockwise Range  
 Friction Cohesion Intercept Angle

No.	(deg)	(psf)	(deg)
1	0.0	200.00	32.00
2	4.0	0.00	20.00
3	90.0	200.00	32.00

ANISOTROPIC SOIL NOTES:

- (1) An input value of 0.01 for C and/or Phi will cause Aniso C and/or Phi to be ignored in that range.
- (2) An input value of 0.02 for Phi will set both Phi and C equal to zero, with no water weight in the tension crack.
- (3) An input value of 0.03 for Phi will set both Phi and C equal to zero, with water weight in the tension crack.

1 PIEZOMETRIC SURFACE(S) SPECIFIED

Unit Weight of Water = 62.40 (pcf)

Piezometric Surface No. 1 Specified by 2 Coordinate Points

Pore Pressure Inclination Factor = 0.50

Point No.	X-Water (ft)	Y-Water (ft)
1	100.00	9.00
2	560.00	10.20

BOUNDARY LOAD(S)

1 Load(s) Specified

Load No.	X-Left (ft)	X-Right (ft)	Intensity (psf)	Deflection (deg)
1	274.50	413.60	250.0	0.0

NOTE - Intensity Is Specified As A Uniformly Distributed Force Acting On A Horizontally Projected Surface.

Janbus Empirical Coef is being used for the case of c & phi both > 0

A Critical Failure Surface Searching Method, Using A Random

Technique For Generating Sliding Block Surfaces, Has Been

Specified.

4999 Trial Surfaces Have Been Generated.

2 Boxes Specified For Generation Of Central Block Base

Length Of Line Segments For Active And Passive Portions Of

Sliding Block Is 30.0

Box No.	X-Left (ft)	Y-Left (ft)	X-Right (ft)	Y-Right (ft)	Height (ft)
1	287.70	52.40	290.20	52.50	2.00
2	334.30	53.80	456.90	57.60	2.00

Following Are Displayed The Ten Most Critical Of The Trial

Failure Surfaces Evaluated. They Are

Ordered - Most Critical First.

\* \* Safety Factors Are Calculated By The Simplified Janbu Method \* \*

Total Number of Trial Surfaces Attempted = 4999

Number of Trial Surfaces With Valid FS = 4999

Statistical Data On All Valid FS Values:

FS Max = 98.072 FS Min = 4.183 FS Ave = 14.904

Standard Deviation = 11.155 Coefficient of Variation = 74.85 %

Failure Surface Specified by 6 Coordinate Points

Point No.	X-Surf (ft)	Y-Surf (ft)
1	242.026	55.222
2	260.068	51.993
3	290.066	51.624
4	420.795	56.695
5	441.631	78.279
6	446.982	84.790

Factor of Safety

\*\*\* 4.183 \*\*\*

Slice No.	Width (ft)	Weight (lbs)	Individual data on the		18 slices		Earthquake		
			Water Top (lbs)	Water Bot (lbs)	Tie Force Norm (lbs)	Tie Force Tan (lbs)	Hor Force (lbs)	Ver Force (lbs)	Surcharge Load (lbs)
1	6.4	1658.4	0.0	0.0	0.0	0.0	0.0	0.0	0.0
2	11.7	11631.2	0.0	0.0	0.0	0.0	0.0	0.0	0.0
3	9.4	16637.9	0.0	0.0	0.0	0.0	0.0	0.0	0.0
4	5.0	10329.5	0.0	0.0	0.0	0.0	0.0	0.0	0.0
5	2.1	4344.1	0.0	0.0	0.0	0.0	0.0	0.0	521.7
6	0.3	653.7	0.0	0.0	0.0	0.0	0.0	0.0	78.3
7	3.2	6703.8	0.0	0.0	0.0	0.0	0.0	0.0	800.0

8	10.0	21170.4	0.0	0.0	0.	0.	0.0	0.0	2491.4
9	22.6	48160.6	0.0	0.0	0.	0.	0.0	0.0	5658.6
10	5.8	12203.6	0.0	0.0	0.	0.	0.0	0.0	1450.0
11	7.2	15071.4	0.0	0.0	0.	0.	0.0	0.0	1800.0
12	73.6	148761.8	0.0	0.0	0.	0.	0.0	0.0	18405.5
13	14.3	27714.4	0.0	0.0	0.	0.	0.0	0.0	3569.5
14	4.9	9426.1	0.0	0.0	0.	0.	0.0	0.0	0.0
15	0.0	26.5	0.0	0.0	0.	0.	0.0	0.0	0.0
16	2.3	7691.9	0.0	0.0	0.	0.	0.0	0.0	0.0
17	20.8	43138.2	0.0	0.0	0.	0.	0.0	0.0	0.0
18	5.4	2085.3	0.0	0.0	0.	0.	0.0	0.0	0.0

Failure Surface Specified By 6 Coordinate Points

Point No.	X-Surf (ft)	Y-Surf (ft)
1	242.026	55.222
2	260.068	51.993
3	290.066	51.624
4	420.795	56.695
5	441.631	78.279
6	446.982	84.790

Factor of Safety  
\*\*\* 4.183 \*\*\*

Failure Surface Specified By 6 Coordinate Points

Point No.	X-Surf (ft)	Y-Surf (ft)
1	242.026	55.222
2	260.068	51.993
3	290.066	51.624
4	420.795	56.695
5	441.631	78.279
6	446.982	84.790

Factor of Safety  
\*\*\* 4.183 \*\*\*

Failure Surface Specified By 6 Coordinate Points

Point No.	X-Surf (ft)	Y-Surf (ft)
1	242.026	55.222
2	260.068	51.993
3	290.066	51.624
4	420.795	56.695
5	441.631	78.279
6	446.982	84.790

Factor of Safety  
\*\*\* 4.183 \*\*\*

Failure Surface Specified By 6 Coordinate Points

Point No.	X-Surf (ft)	Y-Surf (ft)
1	242.026	55.222
2	260.068	51.993
3	290.066	51.624
4	420.795	56.695
5	441.631	78.279
6	446.982	84.790

Factor of Safety  
\*\*\* 4.183 \*\*\*

Failure Surface Specified By 6 Coordinate Points

Point No.	X-Surf (ft)	Y-Surf (ft)
1	242.026	55.222
2	260.068	51.993
3	290.066	51.624
4	420.795	56.695
5	441.631	78.279
6	446.982	84.790

Factor of Safety  
\*\*\* 4.183 \*\*\*

Failure Surface Specified By 6 Coordinate Points

Point No.	X-Surf (ft)	Y-Surf (ft)
1	242.026	55.222

2	260.068	51.993
3	290.066	51.624
4	420.795	56.695
5	441.631	78.279
6	446.982	84.790

Factor of Safety  
\*\*\* 4.183 \*\*\*

Failure Surface Specified By 6 Coordinate Points

Point No.	X-Surf (ft)	Y-Surf (ft)
1	242.026	55.222
2	260.068	51.993
3	290.066	51.624
4	420.795	56.695
5	441.631	78.279
6	446.982	84.790

Factor of Safety  
\*\*\* 4.183 \*\*\*

Failure Surface Specified By 6 Coordinate Points

Point No.	X-Surf (ft)	Y-Surf (ft)
1	243.269	55.846
2	258.835	53.125
3	288.813	51.986
4	423.549	56.302
5	444.745	77.532
6	447.003	84.790

Factor of Safety  
\*\*\* 4.354 \*\*\*

Failure Surface Specified By 6 Coordinate Points

Point No.	X-Surf (ft)	Y-Surf (ft)
1	243.269	55.846
2	258.835	53.125
3	288.813	51.986
4	423.549	56.302
5	444.745	77.532
6	447.003	84.790

Factor of Safety  
\*\*\* 4.354 \*\*\*

\*\*\*\* END OF GSTABL7 OUTPUT \*\*\*\*

# 12091-01 / John S. Gibson / Sec. F-F' MSE Wall "D" / Seismic / Along Bedding

z:\2012\12091-01 howard industrial partners - john s gibson blvd\engineering\slope stability\sections\f-f'\fxx2e.pl2 Run By: SHH 3/14/2019 01:42PM

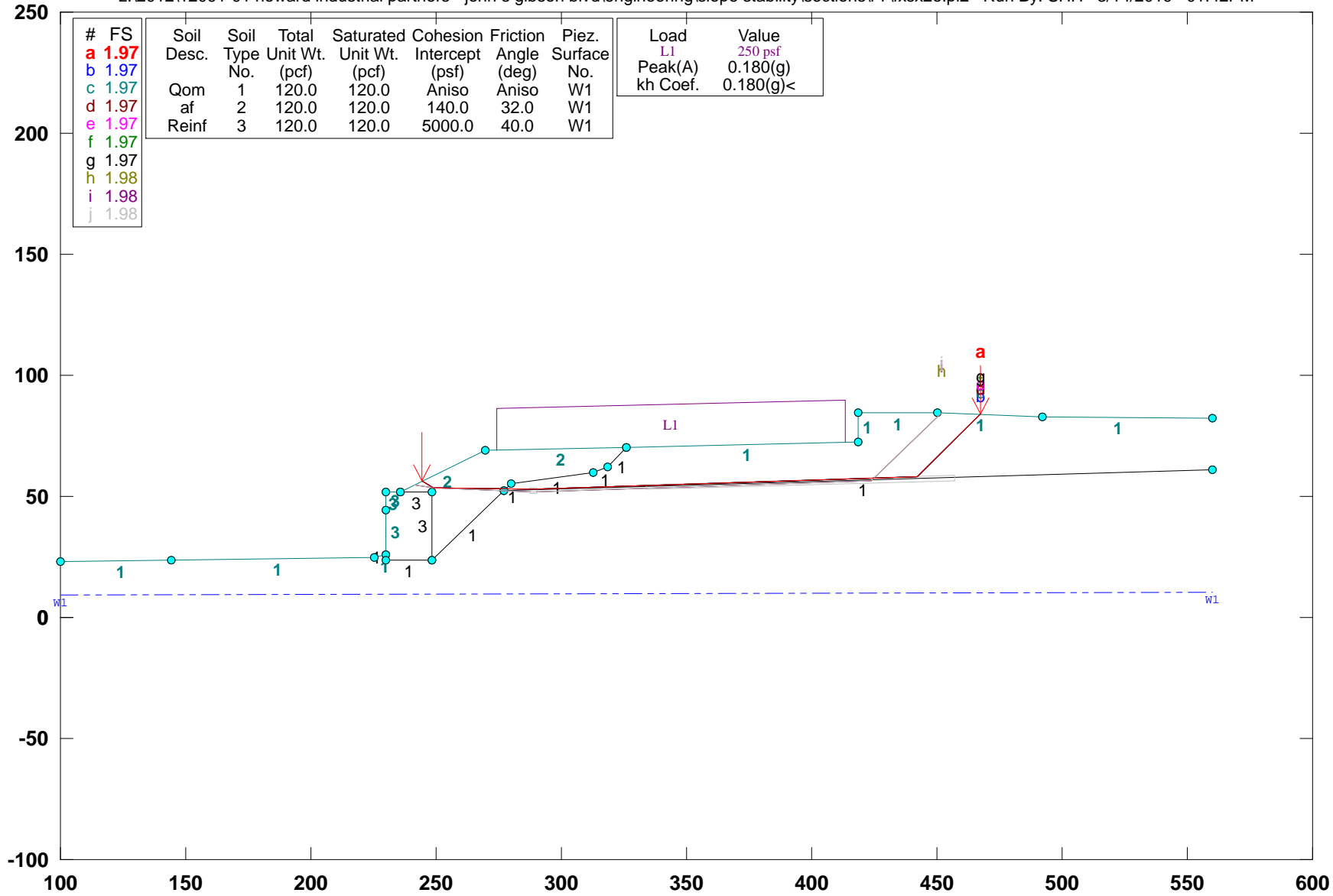

GSTABL7 v.2 FSmin=1.97

Safety Factors Are Calculated By The Simplified Janbu Method for the case of c & phi both > 0

\*\*\* GSTABL7 \*\*\*

\*\* GSTABL7 by Dr. Garry H. Gregory, Ph.D., P.E., D.GE \*\*  
 \*\* Original Version 1.0, January 1996; Current Ver. 2.005.3, Feb. 2013 \*\*  
 (All Rights Reserved-Unauthorized Use Prohibited)

\*\*\*\*\*  
 SLOPE STABILITY ANALYSIS SYSTEM  
 Modified Bishop, Simplified Janbu, or GLE Method of Slices.  
 (Includes Spencer & Morgenstern-Price Type Analysis)  
 Including Pier/Pile, Reinforcement, Soil Nail, Tieback,  
 Nonlinear Undrained Shear Strength, Curved Phi Envelope,  
 Anisotropic Soil, Fiber-Reinforced Soil, Boundary Loads, Water  
 Surfaces, Pseudo-Static & Newmark Earthquake, and Applied Forces.  
 \*\*\*\*\*

Analysis Run Date: 3/14/2019  
 Time of Run: 01:42PM  
 Run By: SHH  
 Input Data Filename: Z:\2012\12091-01 Howard Industrial Partners - John S Gibson  
 Blvd\Engineering\Slope Stability\Sections\F-F'\fxsx2e.in  
 Output Filename: Z:\2012\12091-01 Howard Industrial Partners - John S Gibson  
 Blvd\Engineering\Slope Stability\Sections\F-F'\fxsx2e.OUT  
 Unit System: English  
 Plotted Output Filename: Z:\2012\12091-01 Howard Industrial Partners - John S Gibson  
 Blvd\Engineering\Slope Stability\Sections\F-F'\fxsx2e.PLT  
 PROBLEM DESCRIPTION: 12091-01 / John S. Gibson / Sec. F-F'  
 MSE Wall "D" / Seismic / Along Bedding

BOUNDARY COORDINATES  
 13 Top Boundaries  
 23 Total Boundaries

Boundary No.	X-Left (ft)	Y-Left (ft)	X-Right (ft)	Y-Right (ft)	Soil Type Below	Bnd
1	100.00	23.00	144.10	23.40	1	1
2	144.10	23.40	225.50	25.00	1	1
3	225.50	25.00	230.20	25.90	3	1
4	230.20	25.90	230.21	44.30	3	1
5	230.21	44.30	230.22	52.00	3	3
6	230.22	52.00	235.60	52.00	3	3
7	235.60	52.00	269.50	69.00	2	2
8	269.50	69.00	325.70	70.40	2	2
9	325.70	70.40	418.50	72.60	1	1
10	418.50	72.60	418.51	84.70	1	1
11	418.51	84.70	450.00	84.80	1	1
12	450.00	84.80	492.10	82.90	1	1
13	492.10	82.90	560.00	82.00	1	1
14	235.60	52.00	248.40	52.00	3	3
15	248.40	52.00	248.41	23.90	3	3
16	230.20	25.90	230.21	23.90	1	1
17	230.21	23.90	248.41	23.90	1	1
18	248.41	23.90	276.90	52.10	1	1
19	276.90	52.10	280.10	55.20	1	1
20	280.10	55.20	312.70	60.00	1	1
21	312.70	60.00	318.50	62.40	1	1
22	318.50	62.40	325.70	70.40	1	1
23	276.90	52.10	560.00	60.80	1	1

Default Y-Origin = 0.00(ft)  
 Default X-Plus Value = 0.00(ft)  
 Default Y-Plus Value = 0.00(ft)

ISOTROPIC SOIL PARAMETERS  
 3 Type(s) of Soil

Soil Type	Total Unit Wt. (pcf)	Saturated Unit Wt. (pcf)	Cohesion (psf)	Friction Angle (deg)	Pore Pressure Param. (psf)	Pressure Constant	Piez. Surface
1	120.0	120.0	400.0	37.0	0.00	0.0	1
2	120.0	120.0	140.0	32.0	0.00	0.0	1
3	120.0	120.0	5000.0	40.0	0.00	0.0	1

ANISOTROPIC STRENGTH PARAMETERS  
 1 soil type(s)

Soil Type	1 Is Anisotropic
1	1

Number Of Direction Ranges Specified = 3  
 Direction Counter-clockwise  
 Range Direction Limit Cohesion Intercept Friction Angle

No.	(deg)	(psf)	(deg)
1	0.0	400.00	37.00
2	4.0	0.00	20.00
3	90.0	400.00	37.00

ANISOTROPIC SOIL NOTES:  
 (1) An input value of 0.01 for C and/or Phi will cause Aniso C and/or Phi to be ignored in that range.  
 (2) An input value of 0.02 for Phi will set both Phi and C equal to zero, with no water weight in the tension crack.  
 (3) An input value of 0.03 for Phi will set both Phi and C equal to zero, with water weight in the tension crack.

1 PIEZOMETRIC SURFACE(S) SPECIFIED  
 Unit Weight of Water = 62.40 (pcf)  
 Piezometric Surface No. 1 Specified by 2 Coordinate Points  
 Pore Pressure Inclination Factor = 0.50

Point No.	X-Water (ft)	Y-Water (ft)
1	100.00	9.00
2	560.00	10.20

BOUNDARY LOAD(S)  
 1 Load(s) Specified

Load No.	X-Left (ft)	X-Right (ft)	Intensity (psf)	Deflection (deg)
1	274.50	413.60	250.0	0.0

NOTE - Intensity Is Specified As A Uniformly Distributed Force Acting On A Horizontally Projected Surface.  
 Specified Peak Ground Acceleration Coefficient (A) = 0.180(g)  
 Specified Horizontal Earthquake Coefficient (kh) = 0.180(g)  
 Specified Vertical Earthquake Coefficient (kv) = 0.000(g)  
 Specified Seismic Pore-Pressure Factor = 0.000  
 Janbus Empirical Coef is being used for the case of c & phi both > 0  
 A Critical Failure Surface Searching Method, Using A Random Technique For Generating Sliding Block Surfaces, Has Been Specified.  
 4999 Trial Surfaces Have Been Generated.  
 2 Boxes Specified For Generation Of Central Block Base  
 Length Of Line Segments For Active And Passive Portions Of Sliding Block Is 40.0

Box No.	X-Left (ft)	Y-Left (ft)	X-Right (ft)	Y-Right (ft)	Height (ft)
1	287.70	52.40	290.20	52.50	2.00
2	334.30	53.80	456.90	57.60	2.00

Following Are Displayed The Ten Most Critical Of The Trial Failure Surfaces Evaluated. They Are Ordered - Most Critical First.  
 \* \* Safety Factors Are Calculated By The Simplified Janbu Method \* \*  
 Total Number of Trial Surfaces Attempted = 4999  
 Number of Trial Surfaces With Valid FS = 4999  
 Statistical Data On All Valid FS Values:  
 FS Max = 22.016 FS Min = 1.971 FS Ave = 3.231  
 Standard Deviation = 1.379 Coefficient of Variation = 42.67 %

Failure Surface Specified By 5 Coordinate Points

Point No.	X-Surf (ft)	Y-Surf (ft)
1	244.359	56.392
2	248.744	53.305
3	288.742	52.924
4	442.106	58.000
5	467.663	84.003

Factor of Safety  
 \*\*\* 1.971 \*\*\*

Individual data on the 16 slices

Slice No.	Width (ft)	Weight (lbs)	Water Force		Tie Force		Earthquake Force		Surcharge Load (lbs)
			Top (lbs)	Bot (lbs)	Norm (lbs)	Tan (lbs)	Hor (lbs)	Ver (lbs)	
1	4.0	1180.9	0.0	0.0	0.0	0.0	212.6	0.0	0.0
2	0.3	210.0	0.0	0.0	0.0	0.0	37.8	0.0	0.0
3	20.8	26368.7	0.0	0.0	0.0	0.0	4746.4	0.0	0.0
4	5.0	9583.7	0.0	0.0	0.0	0.0	1725.1	0.0	0.0

5	3.4	6508.1	0.0	0.0	0.	0.	1171.5	0.0	841.3
6	2.2	4347.4	0.0	0.0	0.	0.	782.5	0.0	558.7
7	8.6	17005.4	0.0	0.0	0.	0.	3061.0	0.0	2160.6
8	24.0	47286.2	0.0	0.0	0.	0.	8511.5	0.0	5989.4
9	5.8	11363.6	0.0	0.0	0.	0.	2045.4	0.0	1450.0
10	7.2	14060.9	0.0	0.0	0.	0.	2531.0	0.0	1800.0
11	87.9	167028.6	0.0	0.0	0.	0.	30065.1	0.0	21975.0
12	4.9	9056.6	0.0	0.0	0.	0.	1630.2	0.0	0.0
13	0.0	25.7	0.0	0.0	0.	0.	4.6	0.0	0.0
14	23.6	76811.4	0.0	0.0	0.	0.	13826.1	0.0	0.0
15	7.9	21570.2	0.0	0.0	0.	0.	3882.6	0.0	0.0
16	17.7	19890.5	0.0	0.0	0.	0.	3580.3	0.0	0.0

Failure Surface Specified By 5 Coordinate Points

Point No.	X-Surf (ft)	Y-Surf (ft)
1	244.359	56.392
2	248.744	53.305
3	288.742	52.934
4	442.106	58.000
5	467.663	84.003

Factor of Safety  
\*\*\* 1.971 \*\*\*

Failure Surface Specified By 5 Coordinate Points

Point No.	X-Surf (ft)	Y-Surf (ft)
1	244.359	56.392
2	248.744	53.305
3	288.742	52.934
4	442.106	58.000
5	467.663	84.003

Factor of Safety  
\*\*\* 1.971 \*\*\*

Failure Surface Specified By 5 Coordinate Points

Point No.	X-Surf (ft)	Y-Surf (ft)
1	244.359	56.392
2	248.744	53.305
3	288.742	52.934
4	442.106	58.000
5	467.663	84.003

Factor of Safety  
\*\*\* 1.971 \*\*\*

Failure Surface Specified By 5 Coordinate Points

Point No.	X-Surf (ft)	Y-Surf (ft)
1	244.359	56.392
2	248.744	53.305
3	288.742	52.934
4	442.106	58.000
5	467.663	84.003

Factor of Safety  
\*\*\* 1.971 \*\*\*

Failure Surface Specified By 5 Coordinate Points

Point No.	X-Surf (ft)	Y-Surf (ft)
1	244.359	56.392
2	248.744	53.305
3	288.742	52.934
4	442.106	58.000
5	467.663	84.003

Factor of Safety  
\*\*\* 1.971 \*\*\*

Failure Surface Specified By 5 Coordinate Points

Point No.	X-Surf (ft)	Y-Surf (ft)
1	244.359	56.392
2	248.744	53.305
3	288.742	52.934
4	442.106	58.000
5	467.663	84.003

Factor of Safety

\*\*\* 1.971 \*\*\*

Failure Surface Specified By 6 Coordinate Points

Point No.	X-Surf (ft)	Y-Surf (ft)
1	241.247	54.832
2	248.842	53.505
3	288.813	51.986
4	423.549	56.302
5	451.811	84.609
6	451.844	84.717

Factor of Safety

\*\*\* 1.983 \*\*\*

Failure Surface Specified By 6 Coordinate Points

Point No.	X-Surf (ft)	Y-Surf (ft)
1	241.247	54.832
2	248.842	53.505
3	288.813	51.986
4	423.549	56.302
5	451.811	84.609
6	451.844	84.717

Factor of Safety

\*\*\* 1.983 \*\*\*

Failure Surface Specified By 6 Coordinate Points

Point No.	X-Surf (ft)	Y-Surf (ft)
1	241.247	54.832
2	248.842	53.505
3	288.813	51.986
4	423.549	56.302
5	451.811	84.609
6	451.844	84.717

Factor of Safety

\*\*\* 1.983 \*\*\*

\*\*\*\* END OF GSTABL7 OUTPUT \*\*\*\*

# 12091-01 / John S. Gibson / Sec. G-G' MSE Wall "E" / Static

z:\2012\12091-01 howard industrial partners - john s gibson blvd\engineering\slope stability\sections\g-g'\gx2s.pl2 Run By: LGC Geotechnical 3/14/2019 07:45AM

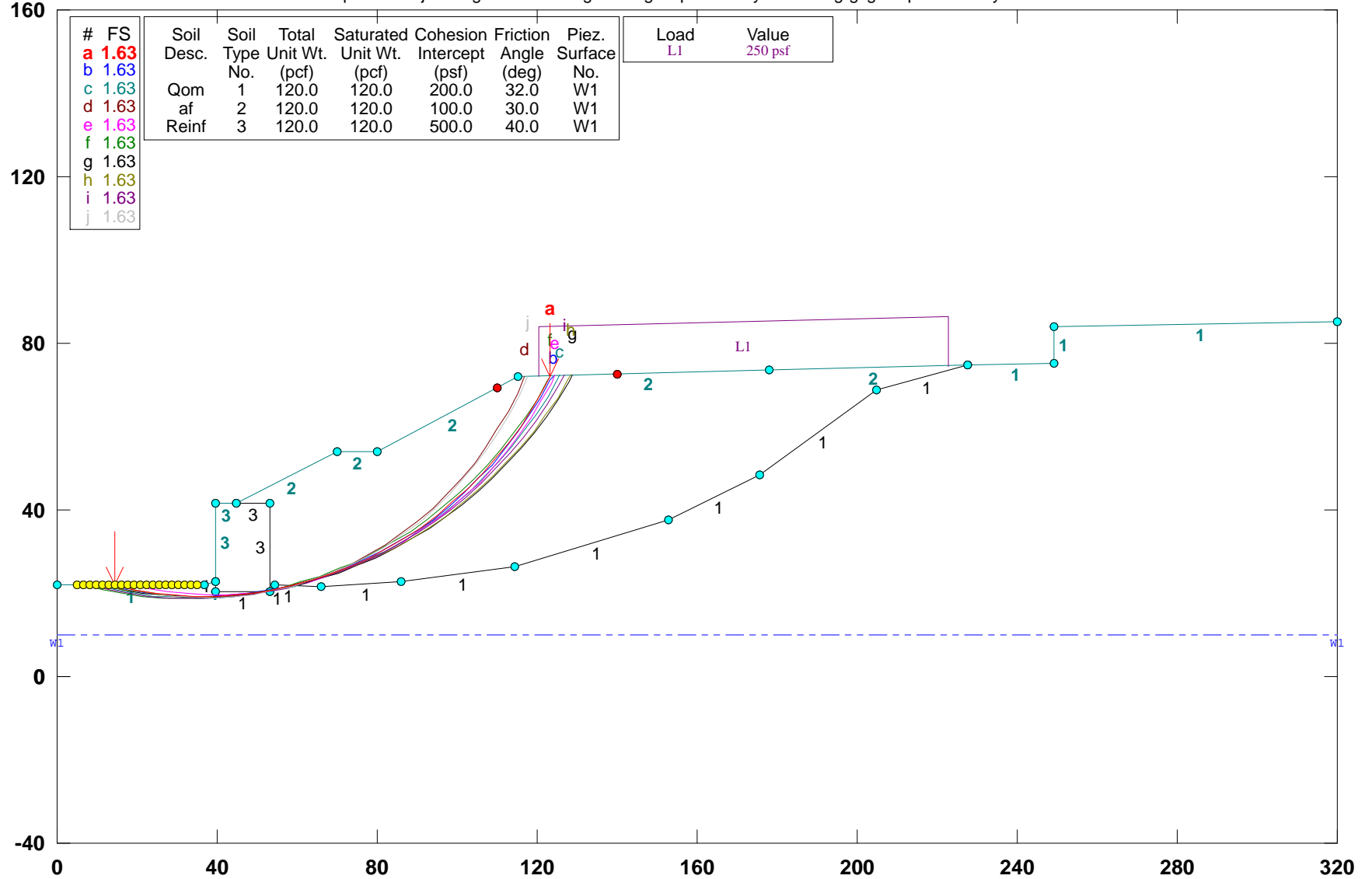

GSTABL7 v.2 FSmin=1.63  
 Safety Factors Are Calculated By The Modified Bishop Method



\*\*\* GSTABL7 \*\*\*

\*\* GSTABL7 by Dr. Garry H. Gregory, Ph.D., P.E., D.GE \*\*  
 \*\* Original Version 1.0, January 1996; Current Ver. 2.005.3, Feb. 2013 \*\*  
 (All Rights Reserved-Unauthorized Use Prohibited)

\*\*\*\*\*

SLOPE STABILITY ANALYSIS SYSTEM

Modified Bishop, Simplified Janbu, or GLE Method of Slices.  
 (Includes Spencer & Morgenstern-Price Type Analysis)  
 Including Pier/Pile, Reinforcement, Soil Nail, Tieback,  
 Nonlinear Undrained Shear Strength, Curved Phi Envelope,  
 Anisotropic Soil, Fiber-Reinforced Soil, Boundary Loads, Water  
 Surfaces, Pseudo-Static & Newmark Earthquake, and Applied Forces.

\*\*\*\*\*

Analysis Run Date: 3/14/2019  
 Time of Run: 07:45AM  
 Run By: LGC Geotechnical  
 Input Data Filename: Z:\2012\12091-01 Howard Industrial Partners - John S Gibson  
 Blvd\Engineering\Slope Stability\Sections\G-G'\gx2s.in  
 Output Filename: Z:\2012\12091-01 Howard Industrial Partners - John S Gibson  
 Blvd\Engineering\Slope Stability\Sections\G-G'\gx2s.OUT  
 Unit System: English  
 Plotted Output Filename: Z:\2012\12091-01 Howard Industrial Partners - John S Gibson  
 Blvd\Engineering\Slope Stability\Sections\G-G'\gx2s.PLT  
 PROBLEM DESCRIPTION: 12091-01 / John S. Gibson / Sec. G-G'  
 MSE Wall "E" / Static

BOUNDARY COORDINATES  
 12 Top Boundaries  
 24 Total Boundaries

Boundary No.	X-Left (ft)	Y-Left (ft)	X-Right (ft)	Y-Right (ft)	Soil Type Below Bnd
1	0.00	22.00	36.70	22.00	1
2	36.70	22.00	39.70	22.60	1
3	39.70	22.60	39.71	41.50	3
4	39.71	41.50	44.70	41.50	3
5	44.70	41.50	70.10	54.00	2
6	70.10	54.00	80.00	54.00	2
7	80.00	54.00	115.30	72.00	2
8	115.30	72.00	177.80	73.40	2
9	177.80	73.40	227.60	74.60	2
10	227.60	74.60	249.10	75.00	1
11	249.10	75.00	249.11	83.90	1
12	249.11	83.90	320.00	85.20	1
13	44.70	41.50	53.00	41.50	3
14	53.00	41.50	53.01	20.60	3
15	39.70	22.60	39.71	20.60	1
16	39.71	20.60	53.01	20.60	1
17	53.01	20.60	54.40	22.00	1
18	54.40	22.00	66.00	21.70	1
19	66.00	21.70	86.20	22.60	1
20	86.20	22.60	114.30	26.40	1
21	114.30	26.40	152.60	37.80	1
22	152.60	37.80	175.80	48.50	1
23	175.80	48.50	204.90	68.70	1
24	204.90	68.70	227.60	74.60	1

Default Y-Origin = 0.00(ft)  
 Default X-Plus Value = 0.00(ft)  
 Default Y-Plus Value = 0.00(ft)

ISOTROPIC SOIL PARAMETERS

Soil Type	Total Unit Wt. (pcf)	Saturated Unit Wt. (pcf)	Cohesion (psf)	Friction Angle (deg)	Pore Pressure Param. (psf)	Pressure Constant (psf)	Piez. Surface
1	120.0	120.0	200.0	32.0	0.00	0.0	1
2	120.0	120.0	100.0	30.0	0.00	0.0	1
3	120.0	120.0	500.0	40.0	0.00	0.0	1

1 PIEZOMETRIC SURFACE(S) SPECIFIED

Unit Weight of Water = 62.40 (pcf)  
 Piezometric Surface No. 1 Specified by 2 Coordinate Points  
 Pore Pressure Inclination Factor = 0.50  
 Point X-Water Y-Water

No.	(ft)	(ft)
1	0.00	10.10
2	320.00	10.10

BOUNDARY LOAD(S)

Load No.	X-Left (ft)	X-Right (ft)	Intensity (psf)	Deflection (deg)
1	120.30	222.60	250.0	0.0

NOTE - Intensity Is Specified As A Uniformly Distributed Force Acting On A Horizontally Projected Surface.

A Critical Failure Surface Searching Method, Using A Random Technique For Generating Circular Surfaces, Has Been Specified.  
 5000 Trial Surfaces Have Been Generated.

250 Surface(s) Initiate(s) From Each Of 20 Points Equally Spaced Along The Ground Surface Between X = 5.00(ft) and X = 35.00(ft)

Each Surface Terminates Between X = 110.00(ft) and X = 140.00(ft)

Unless Further Limitations Were Imposed, The Minimum Elevation At Which A Surface Extends Is Y = 0.00(ft)

5.00(ft) Line Segments Define Each Trial Failure Surface. Following Are Displayed The Ten Most Critical Of The Trial Failure Surfaces Evaluated. They Are Ordered - Most Critical First.

\*\* Safety Factors Are Calculated By The Modified Bishop Method \*\*  
 Total Number of Trial Surfaces Attempted = 5000  
 Number of Trial Surfaces With Valid FS = 5000

Statistical Data On All Valid FS Values:  
 FS Max = 2.914 FS Min = 1.626 FS Ave = 2.259  
 Standard Deviation = 0.336 Coefficient of Variation = 14.88 %  
 Failure Surface Specified By 27 Coordinate Points

Point No.	X-Surf (ft)	Y-Surf (ft)
1	14.474	22.000
2	19.363	20.955
3	24.301	20.165
4	29.272	19.632
5	34.264	19.358
6	39.264	19.342
7	44.259	19.586
8	49.233	20.088
9	54.175	20.847
10	59.071	21.862
11	63.908	23.129
12	68.673	24.644
13	73.353	26.405
14	77.935	28.406
15	82.407	30.642
16	86.758	33.106
17	90.974	35.793
18	95.046	38.694
19	98.963	41.803
20	102.712	45.111
21	106.286	48.608
22	109.673	52.286
23	112.865	56.134
24	115.830	60.143
25	118.630	64.301
26	121.187	68.598
27	123.072	72.174

Circle Center At X = 37.063 ; Y = 115.759 ; and Radius = 96.442

Factor of Safety

1.626 \*\*\*

Individual data on the 40 slices

Slice No.	Width (ft)	Weight (lbs)	Water Force		Tie Force Norm (lbs)	Tie Force Tan (lbs)	Earthquake Force (lbs)	Surcharge Load (lbs)
			Top	Bot				
1	4.9	306.5	0.0	0.0	0.	0.	0.0	0.0
2	4.9	853.0	0.0	0.0	0.	0.	0.0	0.0

3	5.0	1253.5	0.0	0.0	0.	0.	0.0	0.0	0.0
4	5.0	1500.7	0.0	0.0	0.	0.	0.0	0.0	0.0
5	2.4	773.3	0.0	0.0	0.	0.	0.0	0.0	0.0
6	2.6	895.6	0.0	0.0	0.	0.	0.0	0.0	0.0
7	0.4	167.4	0.0	0.0	0.	0.	0.0	0.0	0.0
8	0.0	15.2	0.0	0.0	0.	0.	0.0	0.0	0.0
9	4.5	12021.8	0.0	0.0	0.	0.	0.0	0.0	0.0
10	0.4	1159.7	0.0	0.0	0.	0.	0.0	0.0	0.0
11	4.5	12379.1	0.0	0.0	0.	0.	0.0	0.0	0.0
12	3.3	9677.3	0.0	0.0	0.	0.	0.0	0.0	0.0
13	0.4	1297.6	0.0	0.0	0.	0.	0.0	0.0	0.0
14	0.0	29.8	0.0	0.0	0.	0.	0.0	0.0	0.0
15	0.1	239.9	0.0	0.0	0.	0.	0.0	0.0	0.0
16	1.1	3272.5	0.0	0.0	0.	0.	0.0	0.0	0.0
17	0.2	683.6	0.0	0.0	0.	0.	0.0	0.0	0.0
18	4.7	14599.6	0.0	0.0	0.	0.	0.0	0.0	0.0
19	0.1	192.9	0.0	0.0	0.	0.	0.0	0.0	0.0
20	4.8	15633.7	0.0	0.0	0.	0.	0.0	0.0	0.0
21	4.8	16145.8	0.0	0.0	0.	0.	0.0	0.0	0.0
22	1.4	4921.3	0.0	0.0	0.	0.	0.0	0.0	0.0
23	3.3	11009.3	0.0	0.0	0.	0.	0.0	0.0	0.0
24	4.6	14623.3	0.0	0.0	0.	0.	0.0	0.0	0.0
25	2.1	6215.0	0.0	0.0	0.	0.	0.0	0.0	0.0
26	2.4	7098.1	0.0	0.0	0.	0.	0.0	0.0	0.0
27	4.4	12770.8	0.0	0.0	0.	0.	0.0	0.0	0.0
28	4.2	12180.8	0.0	0.0	0.	0.	0.0	0.0	0.0
29	4.1	11429.5	0.0	0.0	0.	0.	0.0	0.0	0.0
30	3.9	10537.0	0.0	0.0	0.	0.	0.0	0.0	0.0
31	3.7	9525.2	0.0	0.0	0.	0.	0.0	0.0	0.0
32	3.6	8418.6	0.0	0.0	0.	0.	0.0	0.0	0.0
33	3.4	7243.3	0.0	0.0	0.	0.	0.0	0.0	0.0
34	3.2	6027.1	0.0	0.0	0.	0.	0.0	0.0	0.0
35	2.4	3977.5	0.0	0.0	0.	0.	0.0	0.0	0.0
36	0.6	812.1	0.0	0.0	0.	0.	0.0	0.0	0.0
37	2.8	3272.4	0.0	0.0	0.	0.	0.0	0.0	0.0
38	1.7	1280.6	0.0	0.0	0.	0.	0.0	0.0	0.0
39	0.9	454.4	0.0	0.0	0.	0.	0.0	0.0	221.8
40	1.9	399.7	0.0	0.0	0.	0.	0.0	0.0	471.2

Failure Surface Specified By 28 Coordinate Points

Point No.	X-Surf (ft)	Y-Surf (ft)
1	12.895	22.000
2	17.785	20.960
3	22.722	20.167
4	27.692	19.623
5	32.684	19.329
6	37.684	19.287
7	42.679	19.497
8	47.658	19.957
9	52.607	20.667
10	57.515	21.625
11	62.368	22.829
12	67.154	24.275
13	71.861	25.960
14	76.478	27.879
15	80.993	30.028
16	85.394	32.402
17	89.670	34.993
18	93.810	37.797
19	97.804	40.805
20	101.642	44.010
21	105.313	47.404
22	108.810	50.978
23	112.122	54.723
24	115.242	58.631
25	118.161	62.690
26	120.873	66.891
27	123.370	71.222
28	125.665	75.679

Circle Center At X = 36.023 ; Y = 118.635 ; and Radius = 99.365

Factor of Safety  
\*\*\* 1.627 \*\*\*

Failure Surface Specified By 29 Coordinate Points

Point No.	X-Surf (ft)	Y-Surf (ft)
1	9.737	22.000
2	14.613	20.893
3	19.536	20.023
4	24.496	19.391
5	29.481	19.000
6	34.479	18.851
7	39.478	18.943
8	44.467	19.277
9	49.434	19.851
10	54.367	20.665
11	59.255	21.716
12	64.087	23.002
13	68.851	24.520
14	73.536	26.267
15	78.131	28.238
16	82.626	30.429
17	87.009	32.834
18	91.271	35.448
19	95.402	38.266
20	99.392	41.279
21	103.231	44.482
22	106.911	47.867
23	110.424	51.425
24	113.760	55.149
25	116.912	59.031
26	119.874	63.059
27	122.637	67.227
28	125.195	71.522
29	125.571	72.230

Circle Center At X = 35.072 ; Y = 122.285 ; and Radius = 103.436

Factor of Safety  
\*\*\* 1.630 \*\*\*

Failure Surface Specified By 26 Coordinate Points

Point No.	X-Surf (ft)	Y-Surf (ft)
1	14.474	22.000
2	19.338	20.842
3	24.260	19.966
4	29.225	19.376
5	34.216	19.073
6	39.216	19.059
7	44.209	19.334
8	49.177	19.896
9	54.105	20.745
10	58.975	21.876
11	63.772	23.286
12	68.479	24.971
13	73.082	26.925
14	77.564	29.141
15	81.911	31.612
16	86.107	34.330
17	90.140	37.285
18	93.996	40.469
19	97.661	43.869
20	101.125	47.476
21	104.374	51.276
22	107.398	55.258
23	110.188	59.407
24	112.733	63.711
25	115.026	68.154
26	116.751	72.033

Circle Center At X = 36.961 ; Y = 105.586 ; and Radius = 86.558

Factor of Safety  
\*\*\* 1.630 \*\*\*

Failure Surface Specified By 27 Coordinate Points

Point No.	X-Surf (ft)	Y-Surf (ft)
1	17.632	22.000
2	22.535	21.023
3	27.483	20.303
4	32.462	19.842
5	37.458	19.641
6	42.457	19.700
7	47.447	20.020
8	52.414	20.599
9	57.343	21.436
10	62.222	22.529
11	67.038	23.874
12	71.777	25.468
13	76.426	27.307
14	80.974	29.386
15	85.407	31.699
16	89.713	34.240
17	93.881	37.001
18	97.900	39.976
19	101.758	43.156
20	105.446	46.533
21	108.952	50.097
22	112.268	53.839
23	115.385	57.749
24	118.294	61.816
25	120.987	66.029
26	123.457	70.376
27	124.372	72.203

Circle Center At X = 38.820 ; Y = 115.585 ; and Radius = 95.954  
 Factor of Safety  
 \*\*\* 1.631 \*\*\*

Failure Surface Specified By 29 Coordinate Points

Point No.	X-Surf (ft)	Y-Surf (ft)
1	6.579	22.000
2	11.448	20.862
3	16.366	19.960
4	21.321	19.296
5	26.303	18.872
6	31.300	18.690
7	36.300	18.748
8	41.291	19.047
9	46.262	19.587
10	51.200	20.366
11	56.096	21.383
12	60.937	22.634
13	65.712	24.118
14	70.409	25.830
15	75.019	27.767
16	79.530	29.924
17	83.931	32.296
18	88.213	34.878
19	92.366	37.663
20	96.379	40.645
21	100.243	43.818
22	103.950	47.173
23	107.491	50.703
24	110.858	54.400
25	114.042	58.255
26	117.036	62.260
27	119.834	66.403
28	122.429	70.678
29	123.243	72.178

Circle Center At X = 32.591 ; Y = 122.289 ; and Radius = 103.608  
 Factor of Safety  
 \*\*\* 1.632 \*\*\*

Failure Surface Specified By 29 Coordinate Points

Point No.	X-Surf (ft)	Y-Surf (ft)
-----------	-------------	-------------

1	11.316	22.000
2	16.211	20.984
3	21.149	20.195
4	26.117	19.634
5	31.106	19.303
6	36.105	19.203
7	41.104	19.334
8	46.091	19.695
9	51.056	20.285
10	55.988	21.104
11	60.877	22.150
12	65.713	23.421
13	70.485	24.913
14	75.184	26.623
15	79.798	28.549
16	84.319	30.685
17	88.736	33.028
18	93.040	35.572
19	97.223	38.312
20	101.274	41.242
21	105.187	44.356
22	108.951	47.646
23	112.559	51.108
24	116.004	54.731
25	119.278	58.510
26	122.375	62.436
27	125.286	66.501
28	128.007	70.696
29	128.949	72.306

Circle Center At X = 35.777 ; Y = 127.548 ; and Radius = 108.345  
 Factor of Safety  
 \*\*\* 1.632 \*\*\*

Failure Surface Specified By 29 Coordinate Points

Point No.	X-Surf (ft)	Y-Surf (ft)
1	11.316	22.000
2	16.212	20.988
3	21.150	20.204
4	26.120	19.650
5	31.109	19.327
6	36.108	19.236
7	41.106	19.377
8	46.093	19.750
9	51.056	20.353
10	55.986	21.186
11	60.872	22.247
12	65.704	23.533
13	70.471	25.042
14	75.162	26.771
15	79.769	28.715
16	84.280	30.871
17	88.687	33.234
18	92.979	35.799
19	97.147	38.560
20	101.183	41.511
21	105.078	44.647
22	108.823	47.960
23	112.410	51.443
24	115.832	55.088
25	119.082	58.889
26	122.151	62.836
27	125.034	66.921
28	127.724	71.135
29	128.390	72.293

Circle Center At X = 35.571 ; Y = 126.997 ; and Radius = 107.763  
 Factor of Safety  
 \*\*\* 1.632 \*\*\*

Failure Surface Specified By 29 Coordinate Points

Point No.	X-Surf (ft)	Y-Surf (ft)
-----------	-------------	-------------

1	8.158	22.000
2	13.035	20.896
3	17.957	20.022
4	22.916	19.378
5	27.899	18.967
6	32.896	18.789
7	37.895	18.844
8	42.887	19.134
9	47.860	19.656
10	52.802	20.410
11	57.705	21.394
12	62.555	22.607
13	67.344	24.044
14	72.061	25.704
15	76.694	27.583
16	81.235	29.676
17	85.673	31.979
18	89.999	34.486
19	94.203	37.193
20	98.275	40.094
21	102.208	43.182
22	105.992	46.450
23	109.619	49.892
24	113.082	53.499
25	116.372	57.264
26	119.482	61.179
27	122.406	65.234
28	125.137	69.422
29	126.803	72.258

Circle Center At X = 34.203 ; Y = 125.744 ; and Radius = 106.964  
 Factor of Safety  
 \*\*\* 1.633 \*\*\*

Failure Surface Specified By 26 Coordinate Points

Point No.	X-Surf (ft)	Y-Surf (ft)
1	14.474	22.000
2	19.335	20.832
3	24.256	19.944
4	29.219	19.340
5	34.209	19.022
6	39.209	18.990
7	44.202	19.246
8	49.173	19.787
9	54.104	20.613
10	58.980	21.720
11	63.785	23.105
12	68.501	24.764
13	73.115	26.690
14	77.611	28.878
15	81.974	31.320
16	86.190	34.009
17	90.245	36.935
18	94.125	40.088
19	97.817	43.459
20	101.310	47.037
21	104.593	50.809
22	107.653	54.763
23	110.482	58.886
24	113.069	63.164
25	115.407	67.584
26	117.450	72.048

Circle Center At X = 37.257 ; Y = 106.085 ; and Radius = 87.117  
 Factor of Safety  
 \*\*\* 1.634 \*\*\*  
 \*\*\*\*\* END OF GSTABL7 OUTPUT \*\*\*\*\*

# 12091-01 / John S. Gibson / Sec. G-G' MSE Wall "E" / Seismic

z:\2012\12091-01 howard industrial partners - john s gibson blvd\engineering\slope stability\sections\g-g'\gx2se.pl2 Run By: LGC Geotechnical 3/14/2019 08:01AM

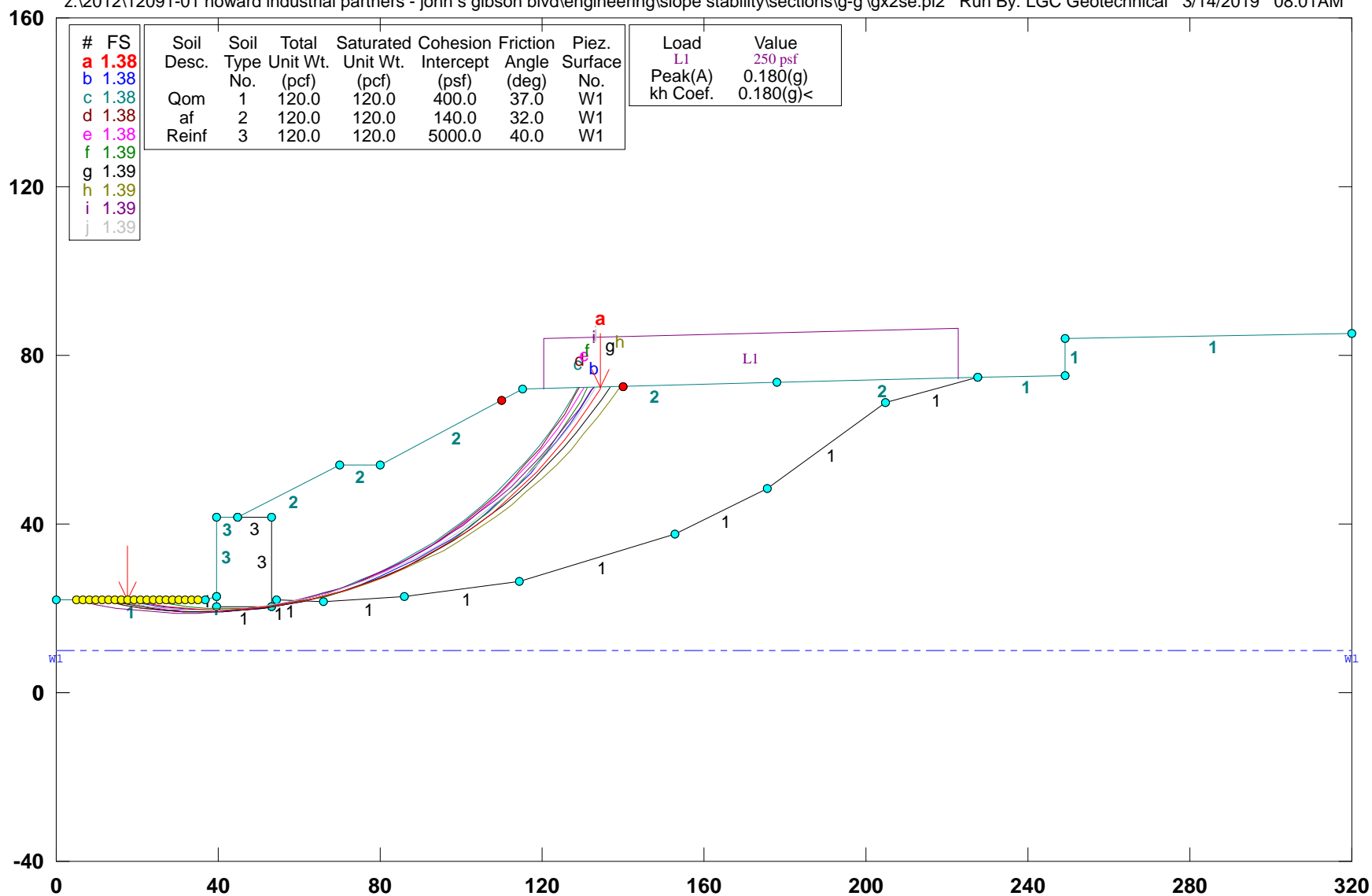

GSTABL7 v.2 FSmin=1.38

Safety Factors Are Calculated By The Modified Bishop Method

\*\*\* GSTABL7 \*\*\*

\*\* GSTABL7 by Dr. Garry H. Gregory, Ph.D., P.E., D.GE \*\*

\*\* Original Version 1.0, January 1996; Current Ver. 2.005.3, Feb. 2013 \*\*  
(All Rights Reserved-Unauthorised Use Prohibited)

\*\*\*\*\*

SLOPE STABILITY ANALYSIS SYSTEM

Modified Bishop, Simplified Janbu, or GLE Method of Slices.  
(Includes Spencer & Morgenstern-Price Type Analysis)  
Including Pier/Pile, Reinforcement, Soil Nail, Tieback,  
Nonlinear Undrained Shear Strength, Curved Phi Envelope,  
Anisotropic Soil, Fiber-Reinforced Soil, Boundary Loads, Water  
Surfaces, Pseudo-Static & Newmark Earthquake, and Applied Forces.

\*\*\*\*\*

Analysis Run Date: 3/14/2019  
Time of Run: 08:01AM  
Run By: LGC Geotechnical  
Input Data Filename: Z:\2012\12091-01 Howard Industrial Partners - John S Gibson  
Blvd\Engineering\Slope Stability\Sections\G-G'\gx2se.in  
Output Filename: Z:\2012\12091-01 Howard Industrial Partners - John S Gibson  
Blvd\Engineering\Slope Stability\Sections\G-G'\gx2se.OUT  
Unit System: English  
Plotted Output Filename: Z:\2012\12091-01 Howard Industrial Partners - John S Gibson  
Blvd\Engineering\Slope Stability\Sections\G-G'\gx2se.PLT  
PROBLEM DESCRIPTION: 12091-01 / John S. Gibson / Sec. G-G'  
MSE Wall "E" / Seismic

BOUNDARY COORDINATES

12 Top Boundaries  
24 Total Boundaries

Boundary No.	X-Left (ft)	Y-Left (ft)	X-Right (ft)	Y-Right (ft)	Soil Type Below Bnd
1	0.00	22.00	36.70	22.00	1
2	36.70	22.00	39.70	22.60	1
3	39.70	22.60	39.71	41.50	3
4	39.71	41.50	44.70	41.50	3
5	44.70	41.50	70.10	54.00	2
6	70.10	54.00	80.00	54.00	2
7	80.00	54.00	115.30	72.00	2
8	115.30	72.00	177.80	73.40	2
9	177.80	73.40	227.60	74.60	2
10	227.60	74.60	249.10	75.00	1
11	249.10	75.00	249.11	83.90	1
12	249.11	83.90	320.00	85.20	1
13	44.70	41.50	53.00	41.50	3
14	53.00	41.50	53.01	20.60	3
15	39.70	22.60	39.71	20.60	1
16	39.71	20.60	53.01	20.60	1
17	53.01	20.60	54.40	22.00	1
18	54.40	22.00	66.00	21.70	1
19	66.00	21.70	86.20	22.60	1
20	86.20	22.60	114.30	26.40	1
21	114.30	26.40	152.60	37.80	1
22	152.60	37.80	175.80	48.50	1
23	175.80	48.50	204.90	68.70	1
24	204.90	68.70	227.60	74.60	1

Default Y-Origin = 0.00(ft)  
Default X-Plus Value = 0.00(ft)  
Default Y-Plus Value = 0.00(ft)

ISOTROPIC SOIL PARAMETERS

3 Type(s) of Soil

Soil Type No.	Total Unit Wt. (pcf)	Saturated Unit Wt. (pcf)	Cohesion (psf)	Friction Angle (deg)	Pore Pressure Param. (psf)	Pressure Constant	Piez. Surface No.
1	120.0	120.0	400.0	37.0	0.00	0.0	1
2	120.0	120.0	140.0	32.0	0.00	0.0	1
3	120.0	120.0	5000.0	40.0	0.00	0.0	1

1 PIEZOMETRIC SURFACE(S) SPECIFIED

Unit Weight of Water = 62.40 (pcf)  
Piezometric Surface No. 1 Specified by 2 Coordinate Points  
Pore Pressure Inclination Factor = 0.50  
Point X-Water Y-Water

No.	(ft)	(ft)
1	0.00	10.10
2	320.00	10.10

BOUNDARY LOAD(S)

Load No.	X-Left (ft)	X-Right (ft)	Intensity (psf)	Deflection (deg)
1	120.30	222.60	250.0	0.0

NOTE - Intensity Is Specified As A Uniformly Distributed Force Acting On A Horizontally Projected Surface.

Specified Peak Ground Acceleration Coefficient (A) = 0.180(g)  
Specified Horizontal Earthquake Coefficient (kh) = 0.180(g)  
Specified Vertical Earthquake Coefficient (kv) = 0.000(g)  
Specified Seismic Pore-Pressure Factor = 0.000

A Critical Failure Surface Searching Method, Using A Random Technique For Generating Circular Surfaces, Has Been Specified.  
5000 Trial Surfaces Have Been Generated.

250 Surface(s) Initiate(s) From Each Of 20 Points Equally Spaced

Along The Ground Surface Between X = 5.00(ft) and X = 35.00(ft)

Each Surface Terminates Between X = 110.00(ft) and X = 140.00(ft)

Unless Further Limitations Were Imposed, The Minimum Elevation

At Which A Surface Extends Is Y = 0.00(ft)

5.00(ft) Line Segments Define Each Trial Failure Surface.

Following Are Displayed The Ten Most Critical Of The Trial

Failure Surfaces Evaluated. They Are

Ordered - Most Critical First.

\* \* Safety Factors Are Calculated By The Modified Bishop Method \* \*

Total Number of Trial Surfaces Attempted = 5000

Number of Trial Surfaces With Valid FS = 5000

Statistical Data On All Valid FS Values:

FS Max = 2.537 FS Min = 1.376 FS Ave = 1.992

Standard Deviation = 0.301 Coefficient of Variation = 15.12 %

Failure Surface Specified By 29 Coordinate Points

Point No. X-Surf (ft) Y-Surf (ft)

1	17.632	22.000
2	22.552	21.110
3	27.507	20.441
4	32.487	19.996
5	37.482	19.775
6	42.482	19.778
7	47.477	20.006
8	52.456	20.459
9	57.410	21.135
10	62.329	22.032
11	67.203	23.150
12	72.021	24.485
13	76.774	26.036
14	81.453	27.799
15	86.049	29.770
16	90.550	31.945
17	94.950	34.321
18	99.239	36.892
19	103.407	39.653
20	107.447	42.598
21	111.351	45.722
22	115.111	49.018
23	118.719	52.480
24	122.167	56.101
25	125.450	59.872
26	128.559	63.788
27	131.490	67.839
28	134.235	72.018
29	134.480	72.430

Circle Center At X = 39.902 ; Y = 131.008 ; and Radius = 111.259

Factor of Safety

\*\*\* 1.376 \*\*\*

Individual data on the 40 slices

Slice No.	Width (ft)	Weight (lbs)	Water Force	Water Force	Tie Force	Tie Force	Earthquake Force		Surcharge Load (lbs)
			Top (lbs)	Bot (lbs)	Norm (lbs)	Tan (lbs)	Hor (lbs)	Ver (lbs)	
1	4.9	262.9	0.0	0.0	0.0	0.0	47.3	0.0	0.0
2	5.0	728.3	0.0	0.0	0.0	0.0	131.1	0.0	0.0
3	5.0	1064.8	0.0	0.0	0.0	0.0	191.7	0.0	0.0
4	4.2	1060.5	0.0	0.0	0.0	0.0	190.9	0.0	0.0
5	0.8	214.5	0.0	0.0	0.0	0.0	38.6	0.0	0.0
6	2.2	692.7	0.0	0.0	0.0	0.0	124.7	0.0	0.0
7	0.0	14.7	0.0	0.0	0.0	0.0	2.7	0.0	0.0
8	2.8	7225.8	0.0	0.0	0.0	0.0	1300.6	0.0	0.0
9	2.2	5768.0	0.0	0.0	0.0	0.0	1038.2	0.0	0.0
10	2.8	7410.7	0.0	0.0	0.0	0.0	1333.9	0.0	0.0
11	5.0	14256.7	0.0	0.0	0.0	0.0	2566.2	0.0	0.0
12	0.5	1628.3	0.0	0.0	0.0	0.0	293.1	0.0	0.0
13	0.0	30.2	0.0	0.0	0.0	0.0	5.4	0.0	0.0
14	1.4	4220.4	0.0	0.0	0.0	0.0	759.7	0.0	0.0
15	3.0	9423.2	0.0	0.0	0.0	0.0	1696.2	0.0	0.0
16	3.8	12340.7	0.0	0.0	0.0	0.0	2221.3	0.0	0.0
17	1.1	3821.6	0.0	0.0	0.0	0.0	687.9	0.0	0.0
18	4.9	16833.3	0.0	0.0	0.0	0.0	3030.0	0.0	0.0
19	2.9	10338.6	0.0	0.0	0.0	0.0	1860.9	0.0	0.0
20	1.9	6865.1	0.0	0.0	0.0	0.0	1235.7	0.0	0.0
21	4.8	16393.4	0.0	0.0	0.0	0.0	2950.8	0.0	0.0
22	3.2	10588.7	0.0	0.0	0.0	0.0	1906.0	0.0	0.0
23	1.5	4682.4	0.0	0.0	0.0	0.0	842.8	0.0	0.0
24	4.6	14959.0	0.0	0.0	0.0	0.0	2692.6	0.0	0.0
25	4.5	14788.5	0.0	0.0	0.0	0.0	2661.9	0.0	0.0
26	4.4	14449.3	0.0	0.0	0.0	0.0	2600.9	0.0	0.0
27	4.3	13951.3	0.0	0.0	0.0	0.0	2511.2	0.0	0.0
28	4.2	13306.4	0.0	0.0	0.0	0.0	2395.2	0.0	0.0
29	4.0	12528.4	0.0	0.0	0.0	0.0	2255.1	0.0	0.0
30	3.9	11632.6	0.0	0.0	0.0	0.0	2093.9	0.0	0.0
31	3.8	10635.9	0.0	0.0	0.0	0.0	1914.5	0.0	0.0
32	0.2	518.2	0.0	0.0	0.0	0.0	93.3	0.0	0.0
33	3.4	8696.5	0.0	0.0	0.0	0.0	1565.4	0.0	0.0
34	1.6	3564.4	0.0	0.0	0.0	0.0	641.6	0.0	0.0
35	1.9	3812.0	0.0	0.0	0.0	0.0	686.2	0.0	466.8
36	3.3	5594.8	0.0	0.0	0.0	0.0	1007.1	0.0	820.6
37	3.1	3892.8	0.0	0.0	0.0	0.0	700.7	0.0	777.4
38	2.9	2291.7	0.0	0.0	0.0	0.0	412.5	0.0	732.6
39	2.7	812.2	0.0	0.0	0.0	0.0	146.2	0.0	686.4
40	0.2	6.0	0.0	0.0	0.0	0.0	1.1	0.0	61.2

Failure Surface Specified By 29 Coordinate Points

Point No.	X-Surf (ft)	Y-Surf (ft)
1	16.053	22.000
2	20.964	21.061
3	25.912	20.346
4	30.888	19.859
5	35.882	19.599
6	40.882	19.567
7	45.878	19.763
8	50.860	20.188
9	55.817	20.839
10	60.740	21.716
11	65.617	22.817
12	70.439	24.139
13	75.196	25.680
14	79.877	27.437
15	84.473	29.405
16	88.975	31.581
17	93.372	33.960
18	97.657	36.538
19	101.819	39.309
20	105.850	42.266
21	109.742	45.405
22	113.487	48.718
23	117.077	52.198

24	120.504	55.839
25	123.761	59.633
26	126.842	63.571
27	129.740	67.645
28	132.449	71.848
29	132.765	72.391

Circle Center At X = 39.077 ; Y = 129.054 ; and Radius = 109.502

Factor of Safety

\*\*\* 1.379 \*\*\*

Failure Surface Specified By 29 Coordinate Points

Point No.	X-Surf (ft)	Y-Surf (ft)
1	11.316	22.000
2	16.211	20.984
3	21.149	20.195
4	26.117	19.634
5	31.106	19.303
6	36.105	19.203
7	41.104	19.334
8	46.091	19.695
9	51.056	20.285
10	55.988	21.104
11	60.877	22.150
12	65.713	23.421
13	70.485	24.913
14	75.184	26.623
15	79.798	28.549
16	84.319	30.685
17	88.736	33.028
18	93.040	35.572
19	97.223	38.312
20	101.274	41.242
21	105.187	44.356
22	108.951	47.646
23	112.559	51.108
24	116.004	54.731
25	119.278	58.510
26	122.375	62.436
27	125.286	66.501
28	128.007	70.696
29	128.949	72.306

Circle Center At X = 35.777 ; Y = 127.548 ; and Radius = 108.345

Factor of Safety

\*\*\* 1.379 \*\*\*

Failure Surface Specified By 29 Coordinate Points

Point No.	X-Surf (ft)	Y-Surf (ft)
1	11.316	22.000
2	16.208	20.968
3	21.143	20.163
4	26.109	19.586
5	31.097	19.239
6	36.096	19.122
7	41.095	19.235
8	46.083	19.579
9	51.050	20.153
10	55.985	20.955
11	60.878	21.984
12	65.719	23.237
13	70.496	24.712
14	75.200	26.405
15	79.822	28.314
16	84.350	30.434
17	88.776	32.760
18	93.090	35.288
19	97.283	38.013
20	101.345	40.927
21	105.269	44.026
22	109.046	47.302
23	112.668	50.749

24 116.127 54.360  
 25 119.416 58.126  
 26 122.528 62.039  
 27 125.456 66.092  
 28 128.194 70.276  
 29 129.399 72.316

Circle Center At X = 36.132 ; Y = 127.541 ; and Radius = 108.420

Factor of Safety  
 \*\*\* 1.382 \*\*\*

Failure Surface Specified By 29 Coordinate Points

Point No.	X-Surf (ft)	Y-Surf (ft)
1	12.895	22.000
2	17.800	21.032
3	22.745	20.289
4	27.718	19.771
5	32.709	19.481
6	37.709	19.418
7	42.706	19.583
8	47.691	19.975
9	52.652	20.594
10	57.581	21.438
11	62.465	22.506
12	67.296	23.795
13	72.063	25.303
14	76.757	27.026
15	81.367	28.962
16	85.885	31.105
17	90.300	33.452
18	94.603	35.997
19	98.787	38.736
20	102.841	41.662
21	106.757	44.770
22	110.529	48.053
23	114.146	51.505
24	117.603	55.117
25	120.892	58.884
26	124.005	62.796
27	126.938	66.846
28	129.682	71.025
29	130.463	72.340

Circle Center At X = 36.588 ; Y = 129.176 ; and Radius = 109.763

Factor of Safety  
 \*\*\* 1.383 \*\*\*

Failure Surface Specified By 27 Coordinate Points

Point No.	X-Surf (ft)	Y-Surf (ft)
1	22.368	22.000
2	27.291	21.122
3	32.250	20.488
4	37.235	20.099
5	42.233	19.956
6	47.232	20.060
7	52.220	20.411
8	57.184	21.007
9	62.113	21.848
10	66.994	22.930
11	71.816	24.252
12	76.568	25.810
13	81.236	27.601
14	85.810	29.619
15	90.280	31.861
16	94.633	34.321
17	98.859	36.992
18	102.949	39.868
19	106.892	42.943
20	110.678	46.208
21	114.299	49.657
22	117.745	53.279
23	121.009	57.067

24 124.081 61.012  
 25 126.956 65.103  
 26 129.625 69.331  
 27 131.333 72.359

Circle Center At X = 42.622 ; Y = 121.296 ; and Radius = 101.340

Factor of Safety  
 \*\*\* 1.385 \*\*\*

Failure Surface Specified By 30 Coordinate Points

Point No.	X-Surf (ft)	Y-Surf (ft)
1	11.316	22.000
2	16.223	21.041
3	21.166	20.286
4	26.135	19.738
5	31.124	19.396
6	36.122	19.263
7	41.121	19.337
8	46.114	19.619
9	51.089	20.109
10	56.041	20.805
11	60.959	21.706
12	65.835	22.811
13	70.662	24.117
14	75.429	25.623
15	80.130	27.327
16	84.757	29.224
17	89.300	31.311
18	93.752	33.586
19	98.106	36.044
20	102.355	38.681
21	106.489	41.492
22	110.504	44.473
23	114.391	47.618
24	118.144	50.922
25	121.756	54.379
26	125.221	57.984
27	128.534	61.729
28	131.688	65.609
29	134.678	69.616
30	136.633	72.478

Circle Center At X = 36.840 ; Y = 139.431 ; and Radius = 120.173

Factor of Safety  
 \*\*\* 1.386 \*\*\*

Failure Surface Specified By 30 Coordinate Points

Point No.	X-Surf (ft)	Y-Surf (ft)
1	12.895	22.000
2	17.812	21.092
3	22.761	20.383
4	27.735	19.876
5	32.726	19.570
6	37.725	19.467
7	42.724	19.565
8	47.715	19.866
9	52.689	20.369
10	57.640	21.073
11	62.557	21.976
12	67.435	23.078
13	72.263	24.376
14	77.035	25.869
15	81.743	27.553
16	86.379	29.427
17	90.935	31.486
18	95.404	33.728
19	99.778	36.150
20	104.051	38.746
21	108.216	41.513
22	112.265	44.447
23	116.192	47.542
24	119.990	50.793



25 123.654 54.195  
 26 127.178 57.743  
 27 130.554 61.431  
 28 133.779 65.252  
 29 136.846 69.200  
 30 139.228 72.536

Circle Center At X = 37.788 ; Y = 142.947 ; and Radius = 123.482

Factor of Safety  
 \*\*\* 1.386 \*\*\*

Failure Surface Specified By 31 Coordinate Points

Point No.	X-Surf (ft)	Y-Surf (ft)
1	5.000	22.000
2	9.890	20.956
3	14.819	20.117
4	19.778	19.482
5	24.760	19.054
6	29.755	18.833
7	34.755	18.820
8	39.751	19.014
9	44.735	19.415
10	49.698	20.023
11	54.632	20.836
12	59.527	21.854
13	64.376	23.073
14	69.170	24.493
15	73.901	26.111
16	78.561	27.923
17	83.142	29.927
18	87.636	32.120
19	92.034	34.497
20	96.330	37.055
21	100.517	39.789
22	104.586	42.695
23	108.531	45.766
24	112.346	48.999
25	116.023	52.387
26	119.556	55.925
27	122.939	59.607
28	126.166	63.426
29	129.233	67.375
30	132.132	71.448
31	132.746	72.391

Circle Center At X = 32.578 ; Y = 139.250 ; and Radius = 120.449

Factor of Safety  
 \*\*\* 1.387 \*\*\*

Failure Surface Specified By 29 Coordinate Points

Point No.	X-Surf (ft)	Y-Surf (ft)
1	12.895	22.000
2	17.807	21.069
3	22.756	20.353
4	27.731	19.853
5	32.723	19.571
6	37.722	19.507
7	42.720	19.660
8	47.706	20.032
9	52.671	20.620
10	57.606	21.425
11	62.501	22.443
12	67.347	23.675
13	72.135	25.116
14	76.855	26.765
15	81.499	28.618
16	86.058	30.672
17	90.523	32.922
18	94.886	35.365
19	99.137	37.996
20	103.271	40.810
21	107.277	43.801

22 111.149 46.964  
 23 114.880 50.293  
 24 118.462 53.782  
 25 121.888 57.423  
 26 125.153 61.210  
 27 128.249 65.136  
 28 131.171 69.193  
 29 133.276 72.403

Circle Center At X = 36.697 ; Y = 134.155 ; and Radius = 114.653

Factor of Safety  
 \*\*\* 1.389 \*\*\*

\*\*\*\* END OF GSTABL7 OUTPUT \*\*\*\*

# 12091-01 / John S. Gibson / Sec. G-G' / Static / Along Bedding

z:\2012\12091-01 howard industrial partners - john s gibson blvd\engineering\slope stability\sections\g-g'\gx2.pl2 Run By: SHH 3/6/2019 01:44PM

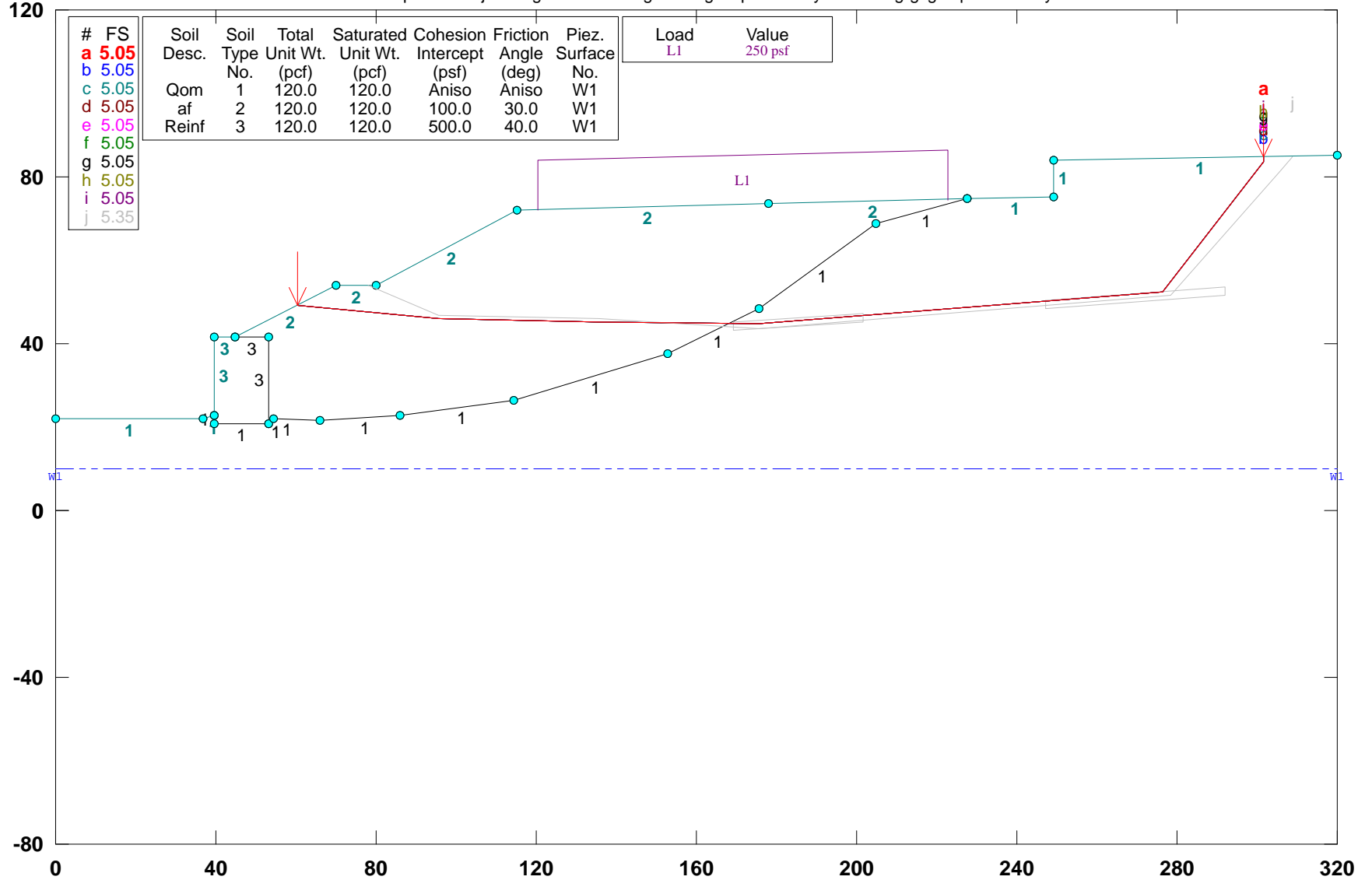

GSTABL7 v.2 FSmin=5.05

Safety Factors Are Calculated By The Simplified Janbu Method for the case of c & phi both > 0

\*\*\* GSTABL7 \*\*\*

\*\* GSTABL7 by Dr. Garry H. Gregory, Ph.D., P.E., D.GE \*\*  
 \*\* Original Version 1.0, January 1996; Current Ver. 2.005.3, Feb. 2013 \*\*  
 (All Rights Reserved-Unauthorized Use Prohibited)

\*\*\*\*\*

SLOPE STABILITY ANALYSIS SYSTEM

Modified Bishop, Simplified Janbu, or GLE Method of Slices.  
 (Includes Spencer & Morgenstern-Price Type Analysis)  
 Including Pier/Pile, Reinforcement, Soil Nail, Tieback,  
 Nonlinear Undrained Shear Strength, Curved Phi Envelope,  
 Anisotropic Soil, Fiber-Reinforced Soil, Boundary Loads, Water  
 Surfaces, Pseudo-Static & Newmark Earthquake, and Applied Forces.

\*\*\*\*\*

Analysis Run Date: 3/6/2019  
 Time of Run: 01:44PM  
 Run By: SHH  
 Input Data Filename: Z:\2012\12091-01 Howard Industrial Partners - John S Gibson  
 Blvd\Engineering\Slope Stability\Sections\G-G'\gx2.in  
 Output Filename: Z:\2012\12091-01 Howard Industrial Partners - John S Gibson  
 Blvd\Engineering\Slope Stability\Sections\G-G'\gx2.OUT  
 Unit System: English  
 Plotted Output Filename: Z:\2012\12091-01 Howard Industrial Partners - John S Gibson  
 Blvd\Engineering\Slope Stability\Sections\G-G'\gx2.PLT  
 PROBLEM DESCRIPTION: 12091-01 / John S. Gibson / Sec. G-G' /  
 Static / Along Bedding

BOUNDARY COORDINATES  
 12 Top Boundaries  
 24 Total Boundaries

Boundary No.	X-Left (ft)	Y-Left (ft)	X-Right (ft)	Y-Right (ft)	Soil Type Below Bnd
1	0.00	22.00	36.70	22.00	1
2	36.70	22.00	39.70	22.60	1
3	39.70	22.60	39.71	41.50	3
4	39.71	41.50	44.70	41.50	3
5	44.70	41.50	70.10	54.00	2
6	70.10	54.00	80.00	54.00	2
7	80.00	54.00	115.30	72.00	2
8	115.30	72.00	177.80	73.40	2
9	177.80	73.40	227.60	74.60	2
10	227.60	74.60	249.10	75.00	1
11	249.10	75.00	249.11	83.90	1
12	249.11	83.90	320.00	85.20	1
13	44.70	41.50	53.00	41.50	3
14	53.00	41.50	53.01	20.60	3
15	39.70	22.60	39.71	20.60	1
16	39.71	20.60	53.01	20.60	1
17	53.01	20.60	54.40	22.00	1
18	54.40	22.00	66.00	21.70	1
19	66.00	21.70	86.20	22.60	1
20	86.20	22.60	114.30	26.40	1
21	114.30	26.40	152.60	37.80	1
22	152.60	37.80	175.80	48.50	1
23	175.80	48.50	204.90	68.70	1
24	204.90	68.70	227.60	74.60	1

Default Y-Origin = 0.00(ft)  
 Default X-Plus Value = 0.00(ft)  
 Default Y-Plus Value = 0.00(ft)

ISOTROPIC SOIL PARAMETERS

3 Type(s) of Soil

Soil Type No.	Total Unit Wt. (pcf)	Saturated Unit Wt. (pcf)	Cohesion (psf)	Friction Angle (deg)	Pore Pressure Param.	Pressure Constant (psf)	Piez. Surface No.
1	120.0	120.0	200.0	32.0	0.00	0.0	1
2	120.0	120.0	100.0	30.0	0.00	0.0	1
3	120.0	120.0	500.0	40.0	0.00	0.0	1

ANISOTROPIC STRENGTH PARAMETERS

1 soil type(s)  
 Soil Type 1 Is Anisotropic  
 Number Of Direction Ranges Specified = 3  
 Direction Counterclockwise Cohesion Friction

Range No.	Direction (deg)	Limit (psf)	Intercept (psf)	Angle (deg)
1	2.0		200.00	32.00
2	6.0		0.00	20.00
3	90.0		200.00	32.00

ANISOTROPIC SOIL NOTES:

- (1) An input value of 0.01 for C and/or Phi will cause Aniso C and/or Phi to be ignored in that range.
- (2) An input value of 0.02 for Phi will set both Phi and C equal to zero, with no water weight in the tension crack.
- (3) An input value of 0.03 for Phi will set both Phi and C equal to zero, with water weight in the tension crack.

1 PIEZOMETRIC SURFACE(S) SPECIFIED

Unit Weight of Water = 62.70 (pcf)  
 Piezometric Surface No. 1 Specified by 2 Coordinate Points  
 Pore Pressure Inclination Factor = 0.50

Point No.	X-Water (ft)	Y-Water (ft)
1	0.00	10.10
2	320.00	10.10

BOUNDARY LOAD(S)

1 Load(s) Specified

Load No.	X-Left (ft)	X-Right (ft)	Intensity (psf)	Deflection (deg)
1	120.30	222.60	250.0	0.0

NOTE - Intensity Is Specified As A Uniformly Distributed Force Acting On A Horizontally Projected Surface.

Janbus Empirical Coef is being used for the case of c & phi both > 0

A Critical Failure Surface Searching Method, Using A Random Technique For Generating Sliding Block Surfaces, Has Been Specified.

4999 Trial Surfaces Have Been Generated.

2 Boxes Specified For Generation Of Central Block Base Length Of Line Segments For Active And Passive Portions Of Sliding Block Is 40.0

Box No.	X-Left (ft)	Y-Left (ft)	X-Right (ft)	Y-Right (ft)	Height (ft)
1	169.10	44.10	201.60	46.40	2.00
2	247.10	49.60	292.00	52.70	2.00

Following Are Displayed The Ten Most Critical Of The Trial Failure Surfaces Evaluated. They Are

Ordered - Most Critical First.

\* \* Safety Factors Are Calculated By The Simplified Janbu Method \* \*

Total Number of Trial Surfaces Attempted = 4999

Number of Trial Surfaces With Valid FS = 4999

Statistical Data On All Valid FS Values:

FS Max = 274.980 FS Min = 5.052 FS Ave = 11.277  
 Standard Deviation = 14.665 Coefficient of Variation = 130.04 %

Failure Surface Specified By 7 Coordinate Points

Point No.	X-Surf (ft)	Y-Surf (ft)
1	60.568	49.309
2	95.739	46.117
3	135.724	45.018
4	175.723	44.754
5	276.574	52.308
6	301.578	83.529
7	301.661	84.864

Factor of Safety

\*\*\* 5.052 \*\*\*

Individual data on the 18 slices

Slice No.	Width (ft)	Weight (lbs)	Water Force		Tie Force		Earthquake Force		Surcharge Load (lbs)
			Top (lbs)	Bot (lbs)	Norm (lbs)	Tan (lbs)	Hor (lbs)	Ver (lbs)	
1	9.5	3177.9	0.0	0.0	0.0	0.0	0.0	0.0	0.0
2	9.9	7134.6	0.0	0.0	0.0	0.0	0.0	0.0	0.0
3	15.7	21119.7	0.0	0.0	0.0	0.0	0.0	0.0	0.0
4	19.6	49680.0	0.0	0.0	0.0	0.0	0.0	0.0	0.0
5	5.0	15927.2	0.0	0.0	0.0	0.0	0.0	0.0	0.0

6	15.4	50075.8	0.0	0.0	0.	0.	0.0	0.0	3856.1
7	32.1	107378.3	0.0	0.0	0.	0.	0.0	0.0	8016.9
8	7.9	27111.4	0.0	0.0	0.	0.	0.0	0.0	1982.9
9	0.1	262.9	0.0	0.0	0.	0.	0.0	0.0	19.2
10	2.0	6850.3	0.0	0.0	0.	0.	0.0	0.0	500.0
11	27.1	90411.9	0.0	0.0	0.	0.	0.0	0.0	6775.0
12	17.7	56634.3	0.0	0.0	0.	0.	0.0	0.0	4425.0
13	5.0	15652.4	0.0	0.0	0.	0.	0.0	0.0	0.0
14	21.5	65416.5	0.0	0.0	0.	0.	0.0	0.0	0.0
15	0.0	35.0	0.0	0.0	0.	0.	0.0	0.0	0.0
16	27.5	108337.1	0.0	0.0	0.	0.	0.0	0.0	0.0
17	25.0	50152.6	0.0	0.0	0.	0.	0.0	0.0	0.0
18	0.1	6.6	0.0	0.0	0.	0.	0.0	0.0	0.0

Failure Surface Specified By 7 Coordinate Points

Point No.	X-Surf (ft)	Y-Surf (ft)
1	60.568	49.309
2	95.739	46.117
3	135.724	45.018
4	175.723	44.754
5	276.574	52.308
6	301.578	83.529
7	301.661	84.864

Factor of Safety  
\*\*\* 5.052 \*\*\*

Failure Surface Specified By 7 Coordinate Points

Point No.	X-Surf (ft)	Y-Surf (ft)
1	60.568	49.309
2	95.739	46.117
3	135.724	45.018
4	175.723	44.754
5	276.574	52.308
6	301.578	83.529
7	301.661	84.864

Factor of Safety  
\*\*\* 5.052 \*\*\*

Failure Surface Specified By 7 Coordinate Points

Point No.	X-Surf (ft)	Y-Surf (ft)
1	60.568	49.309
2	95.739	46.117
3	135.724	45.018
4	175.723	44.754
5	276.574	52.308
6	301.578	83.529
7	301.661	84.864

Factor of Safety  
\*\*\* 5.052 \*\*\*

Failure Surface Specified By 7 Coordinate Points

Point No.	X-Surf (ft)	Y-Surf (ft)
1	60.568	49.309
2	95.739	46.117
3	135.724	45.018
4	175.723	44.754
5	276.574	52.308
6	301.578	83.529
7	301.661	84.864

Factor of Safety  
\*\*\* 5.052 \*\*\*

Failure Surface Specified By 7 Coordinate Points

Point No.	X-Surf (ft)	Y-Surf (ft)
1	60.568	49.309
2	95.739	46.117
3	135.724	45.018
4	175.723	44.754
5	276.574	52.308
6	301.578	83.529

7	301.661	84.864
---	---------	--------

Factor of Safety  
\*\*\* 5.052 \*\*\*

Failure Surface Specified By 7 Coordinate Points

Point No.	X-Surf (ft)	Y-Surf (ft)
1	60.568	49.309
2	95.739	46.117
3	135.724	45.018
4	175.723	44.754
5	276.574	52.308
6	301.578	83.529
7	301.661	84.864

Factor of Safety  
\*\*\* 5.052 \*\*\*

Failure Surface Specified By 7 Coordinate Points

Point No.	X-Surf (ft)	Y-Surf (ft)
1	60.568	49.309
2	95.739	46.117
3	135.724	45.018
4	175.723	44.754
5	276.574	52.308
6	301.578	83.529
7	301.661	84.864

Factor of Safety  
\*\*\* 5.052 \*\*\*

Failure Surface Specified By 7 Coordinate Points

Point No.	X-Surf (ft)	Y-Surf (ft)
1	60.568	49.309
2	95.739	46.117
3	135.724	45.018
4	175.723	44.754
5	276.574	52.308
6	301.578	83.529
7	301.661	84.864

Factor of Safety  
\*\*\* 5.052 \*\*\*

Failure Surface Specified By 7 Coordinate Points

Point No.	X-Surf (ft)	Y-Surf (ft)
1	78.061	54.000
2	95.733	46.615
3	135.726	45.879
4	175.660	43.574
5	278.591	51.490
6	305.571	81.021
7	308.670	84.992

Factor of Safety  
\*\*\* 5.348 \*\*\*

\*\*\*\* END OF GSTABL7 OUTPUT \*\*\*\*

# 12091-01 / John S. Gibson / Sec. G-G' / Seismic / Along Bedding

z:\2012\12091-01 howard industrial partners - john s gibson blvd\engineering\slope stability\sections\g-g'\gx2e.pl2 Run By: SHH 3/14/2019 01:57PM

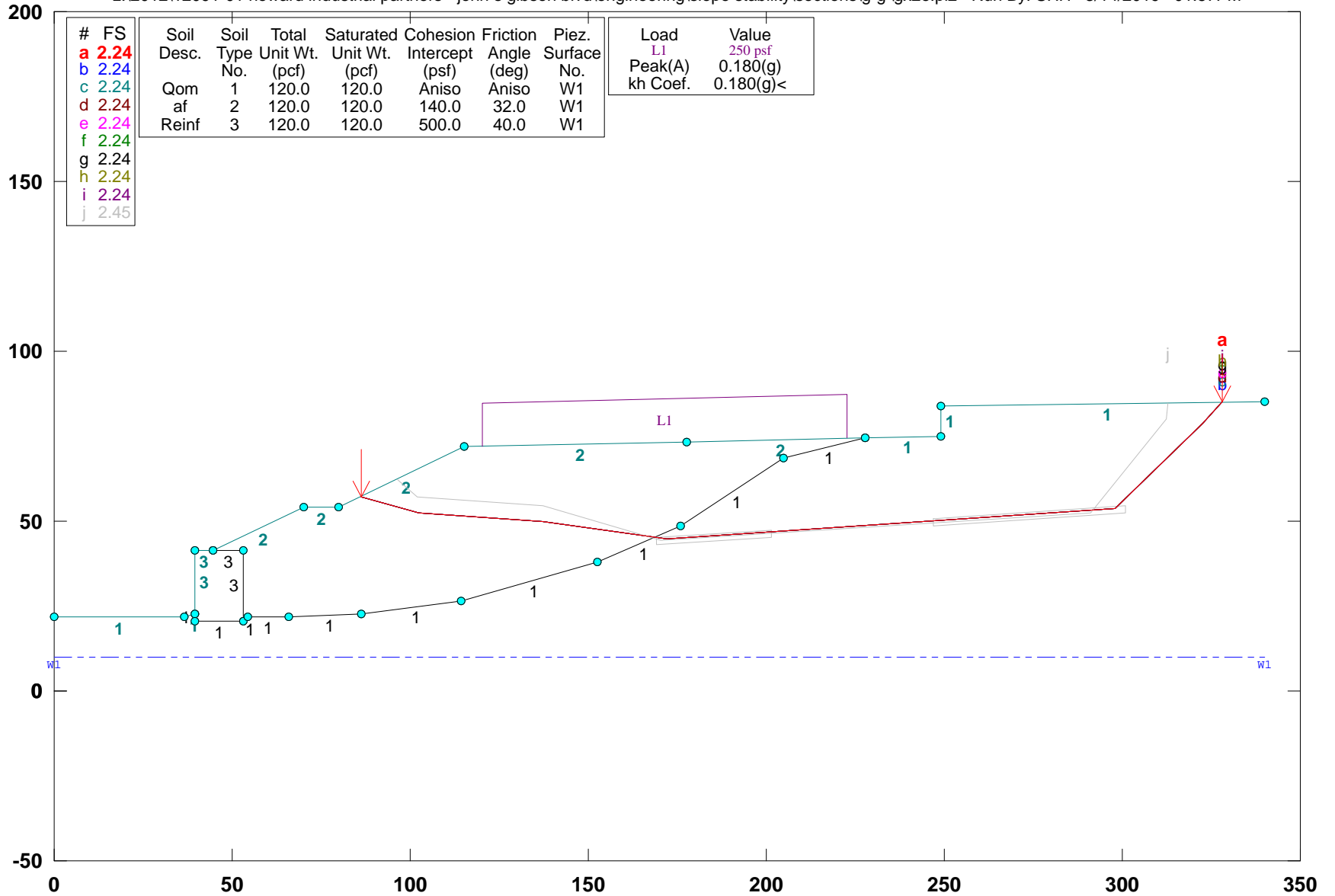

GSTABL7 v.2 FSmin=2.24

Safety Factors Are Calculated By The Simplified Janbu Method for the case of c & phi both > 0

\*\*\* GSTABL7 \*\*\*

\*\* GSTABL7 by Dr. Garry H. Gregory, Ph.D., P.E., D.GE \*\*

\*\* Original Version 1.0, January 1996; Current Ver. 2.005.3, Feb. 2013 \*\*  
(All Rights Reserved-Unauthorized Use Prohibited)

\*\*\*\*\*

SLOPE STABILITY ANALYSIS SYSTEM

Modified Bishop, Simplified Janbu, or GLE Method of Slices.  
(Includes Spencer & Morgenstern-Price Type Analysis)  
Including Pier/Pile, Reinforcement, Soil Nail, Tieback,  
Nonlinear Undrained Shear Strength, Curved Phi Envelope,  
Anisotropic Soil, Fiber-Reinforced Soil, Boundary Loads, Water  
Surfaces, Pseudo-Static & Newmark Earthquake, and Applied Forces.

\*\*\*\*\*

Analysis Run Date: 3/14/2019

Time of Run: 01:57PM

Run By: SHH

Input Data Filename: z:\2012\12091-01 Howard Industrial Partners - John S Gibson

Blvd\Engineering\Slope Stability\Sections\G-G'\gx2e.in

Output Filename: z:\2012\12091-01 Howard Industrial Partners - John S Gibson

Blvd\Engineering\Slope Stability\Sections\G-G'\gx2e.OUT

Unit System: English

Plotted Output Filename: z:\2012\12091-01 Howard Industrial Partners - John S Gibson

Blvd\Engineering\Slope Stability\Sections\G-G'\gx2e.PLT

PROBLEM DESCRIPTION: 12091-01 / John S. Gibson / Sec. G-G' /  
Seismic / Along Bedding

BOUNDARY COORDINATES

12 Top Boundaries

24 Total Boundaries

Boundary No.	X-Left (ft)	Y-Left (ft)	X-Right (ft)	Y-Right (ft)	Soil Type Below Bnd
1	0.00	22.00	36.70	22.00	1
2	36.70	22.00	39.70	22.60	1
3	39.70	22.60	39.71	41.50	3
4	39.71	41.50	44.70	41.50	3
5	44.70	41.50	70.10	54.00	2
6	70.10	54.00	80.00	54.00	2
7	80.00	54.00	115.30	72.00	2
8	115.30	72.00	177.80	73.40	2
9	177.80	73.40	227.60	74.60	2
10	227.60	74.60	249.10	75.00	1
11	249.10	75.00	249.11	83.90	1
12	249.11	83.90	340.00	85.20	1
13	44.70	41.50	53.00	41.50	3
14	53.00	41.50	53.01	20.60	3
15	39.70	22.60	39.71	20.60	1
16	39.71	20.60	53.01	20.60	1
17	53.01	20.60	54.40	22.00	1
18	54.40	22.00	66.00	21.70	1
19	66.00	21.70	86.20	22.60	1
20	86.20	22.60	114.30	26.40	1
21	114.30	26.40	152.60	37.80	1
22	152.60	37.80	175.80	48.50	1
23	175.80	48.50	204.90	68.70	1
24	204.90	68.70	227.60	74.60	1

Default Y-Origin = 0.00(ft)

Default X-Plus Value = 0.00(ft)

Default Y-Plus Value = 0.00(ft)

ISOTROPIC SOIL PARAMETERS

3 Type(s) of Soil

Soil Type No.	Total Unit Wt. (pcf)	Saturated Unit Wt. (pcf)	Cohesion (psf)	Friction Angle (deg)	Pore Pressure Param. (psf)	Pressure Constant	Piez. Surface No.
1	120.0	120.0	400.0	37.0	0.00	0.0	1
2	120.0	120.0	140.0	32.0	0.00	0.0	1
3	120.0	120.0	500.0	40.0	0.00	0.0	1

ANISOTROPIC STRENGTH PARAMETERS

1 soil type(s)

Soil Type 1 Is Anisotropic

Number Of Direction Ranges Specified = 3

Direction Counterclockwise Cohesion Friction

Range No.	Direction (deg)	Limit (psf)	Intercept (psf)	Angle (deg)
1	2.0		400.00	37.00
2	6.0		0.00	20.00
3	90.0		400.00	37.00

ANISOTROPIC SOIL NOTES:

- (1) An input value of 0.01 for C and/or Phi will cause Aniso C and/or Phi to be ignored in that range.
- (2) An input value of 0.02 for Phi will set both Phi and C equal to zero, with no water weight in the tension crack.
- (3) An input value of 0.03 for Phi will set both Phi and C equal to zero, with water weight in the tension crack.

1 PIEZOMETRIC SURFACE(S) SPECIFIED

Unit Weight of Water = 62.70 (pcf)

Piezometric Surface No. 1 Specified by 2 Coordinate Points

Pore Pressure Inclination Factor = 0.50

Point No.	X-Water (ft)	Y-Water (ft)
1	0.00	10.10
2	340.00	10.10

BOUNDARY LOAD(S)

1 Load(s) Specified

Load No.	X-Left (ft)	X-Right (ft)	Intensity (psf)	Deflection (deg)
1	120.30	222.60	250.0	0.0

NOTE - Intensity Is Specified As A Uniformly Distributed Force Acting On A Horizontally Projected Surface.

Specified Peak Ground Acceleration Coefficient (A) = 0.180(g)

Specified Horizontal Earthquake Coefficient (kh) = 0.180(g)

Specified Vertical Earthquake Coefficient (kv) = 0.000(g)

Specified Seismic Pore-Pressure Factor = 0.000

Janbus Empirical Coef is being used for the case of c & phi both > 0

A Critical Failure Surface Searching Method, Using A Random

Technique For Generating Sliding Block Surfaces, Has Been

Specified.

4999 Trial Surfaces Have Been Generated.

2 Boxes Specified For Generation Of Central Block Base

Length Of Line Segments For Active And Passive Portions Of

Sliding Block Is 35.0

Box No.	X-Left (ft)	Y-Left (ft)	X-Right (ft)	Y-Right (ft)	Height (ft)
1	169.10	44.10	201.60	46.40	2.00
2	247.10	49.60	300.70	53.40	2.00

Following Are Displayed The Ten Most Critical Of The Trial

Failure Surfaces Evaluated. They Are

Ordered - Most Critical First.

\* \* Safety Factors Are Calculated By The Simplified Janbu Method \* \*

Total Number of Trial Surfaces Attempted = 4999

Number of Trial Surfaces With Valid FS = 4999

Statistical Data On All Valid FS Values:

FS Max = 9.312 FS Min = 2.244 FS Ave = 3.455

Standard Deviation = 0.829 Coefficient of Variation = 23.98 %

Failure Surface Specified By 7 Coordinate Points

Point No.	X-Surf (ft)	Y-Surf (ft)
1	86.477	57.303
2	102.431	52.313
3	137.348	49.911
4	171.954	44.675
5	297.949	53.804
6	322.403	78.844
7	328.231	85.032

Factor of Safety

\*\*\* 2.244 \*\*\*

Individual data on the 16 slices

Slice No.	Width (ft)	Weight (lbs)	Water Force (lbs)		Tie Force (lbs)		Earthquake Force (lbs)		Surcharge Load (lbs)	
			Top	Bot	Norm	Tan	Hor	Ver		
1	16.0	12563.1	0.0	0.0	0.0	0.0	0.0	2261.4	0.0	0.0

2	12.9	26019.0	0.0	0.0	0.0	0.0	4683.4	0.0	0.0
3	5.0	12480.2	0.0	0.0	0.0	0.0	2246.4	0.0	0.0
4	17.0	44609.9	0.0	0.0	0.0	0.0	8029.8	0.0	4262.1
5	31.3	94889.4	0.0	0.0	0.0	0.0	17080.1	0.0	7814.4
6	3.3	11373.2	0.0	0.0	0.0	0.0	2047.2	0.0	837.2
7	3.8	13150.5	0.0	0.0	0.0	0.0	2367.1	0.0	961.4
8	2.0	6804.3	0.0	0.0	0.0	0.0	1224.8	0.0	500.0
9	27.1	89904.3	0.0	0.0	0.0	0.0	16182.8	0.0	6775.0
10	17.7	56419.2	0.0	0.0	0.0	0.0	10155.5	0.0	4425.0
11	5.0	15608.3	0.0	0.0	0.0	0.0	2809.5	0.0	0.0
12	21.5	65310.4	0.0	0.0	0.0	0.0	11755.9	0.0	0.0
13	0.0	35.0	0.0	0.0	0.0	0.0	6.3	0.0	0.0
14	48.8	188798.0	0.0	0.0	0.0	0.0	33983.6	0.0	0.0
15	24.5	54140.2	0.0	0.0	0.0	0.0	9745.2	0.0	0.0
16	5.8	2134.6	0.0	0.0	0.0	0.0	384.2	0.0	0.0

Failure Surface Specified By 7 Coordinate Points

Point No.	X-Surf (ft)	Y-Surf (ft)
1	86.477	57.303
2	102.431	52.313
3	137.348	49.911
4	171.954	44.675
5	297.949	53.804
6	322.403	78.844
7	328.231	85.032

Factor of Safety  
\*\*\* 2.244 \*\*\*

Failure Surface Specified By 7 Coordinate Points

Point No.	X-Surf (ft)	Y-Surf (ft)
1	86.477	57.303
2	102.431	52.313
3	137.348	49.911
4	171.954	44.675
5	297.949	53.804
6	322.403	78.844
7	328.231	85.032

Factor of Safety  
\*\*\* 2.244 \*\*\*

Failure Surface Specified By 7 Coordinate Points

Point No.	X-Surf (ft)	Y-Surf (ft)
1	86.477	57.303
2	102.431	52.313
3	137.348	49.911
4	171.954	44.675
5	297.949	53.804
6	322.403	78.844
7	328.231	85.032

Factor of Safety  
\*\*\* 2.244 \*\*\*

Failure Surface Specified By 7 Coordinate Points

Point No.	X-Surf (ft)	Y-Surf (ft)
1	86.477	57.303
2	102.431	52.313
3	137.348	49.911
4	171.954	44.675
5	297.949	53.804
6	322.403	78.844
7	328.231	85.032

Factor of Safety  
\*\*\* 2.244 \*\*\*

Failure Surface Specified By 7 Coordinate Points

Point No.	X-Surf (ft)	Y-Surf (ft)
1	86.477	57.303
2	102.431	52.313
3	137.348	49.911
4	171.954	44.675

5	297.949	53.804
6	322.403	78.844
7	328.231	85.032

Factor of Safety  
\*\*\* 2.244 \*\*\*

Failure Surface Specified By 7 Coordinate Points

Point No.	X-Surf (ft)	Y-Surf (ft)
1	86.477	57.303
2	102.431	52.313
3	137.348	49.911
4	171.954	44.675
5	297.949	53.804
6	322.403	78.844
7	328.231	85.032

Factor of Safety  
\*\*\* 2.244 \*\*\*

Failure Surface Specified By 7 Coordinate Points

Point No.	X-Surf (ft)	Y-Surf (ft)
1	86.477	57.303
2	102.431	52.313
3	137.348	49.911
4	171.954	44.675
5	297.949	53.804
6	322.403	78.844
7	328.231	85.032

Factor of Safety  
\*\*\* 2.244 \*\*\*

Failure Surface Specified By 7 Coordinate Points

Point No.	X-Surf (ft)	Y-Surf (ft)
1	86.477	57.303
2	102.431	52.313
3	137.348	49.911
4	171.954	44.675
5	297.949	53.804
6	322.403	78.844
7	328.231	85.032

Factor of Safety  
\*\*\* 2.244 \*\*\*

Failure Surface Specified By 7 Coordinate Points

Point No.	X-Surf (ft)	Y-Surf (ft)
1	96.402	62.364
2	102.134	56.916
3	137.068	54.757
4	170.550	44.562
5	290.922	52.381
6	312.527	79.917
7	312.853	84.812

Factor of Safety  
\*\*\* 2.451 \*\*\*

\*\*\*\* END OF GSTABL7 OUTPUT \*\*\*\*

# 12091-01 / John S. Gibson / Sec. H-H' MSE Wall "E" / Static

z:\2012\12091-01 howard industrial partners - john s gibson blvd\engineering\slope stability\sections\h-h'\hxsx.pl2 Run By: LGC Geotechnical 3/14/2019 09:50AM

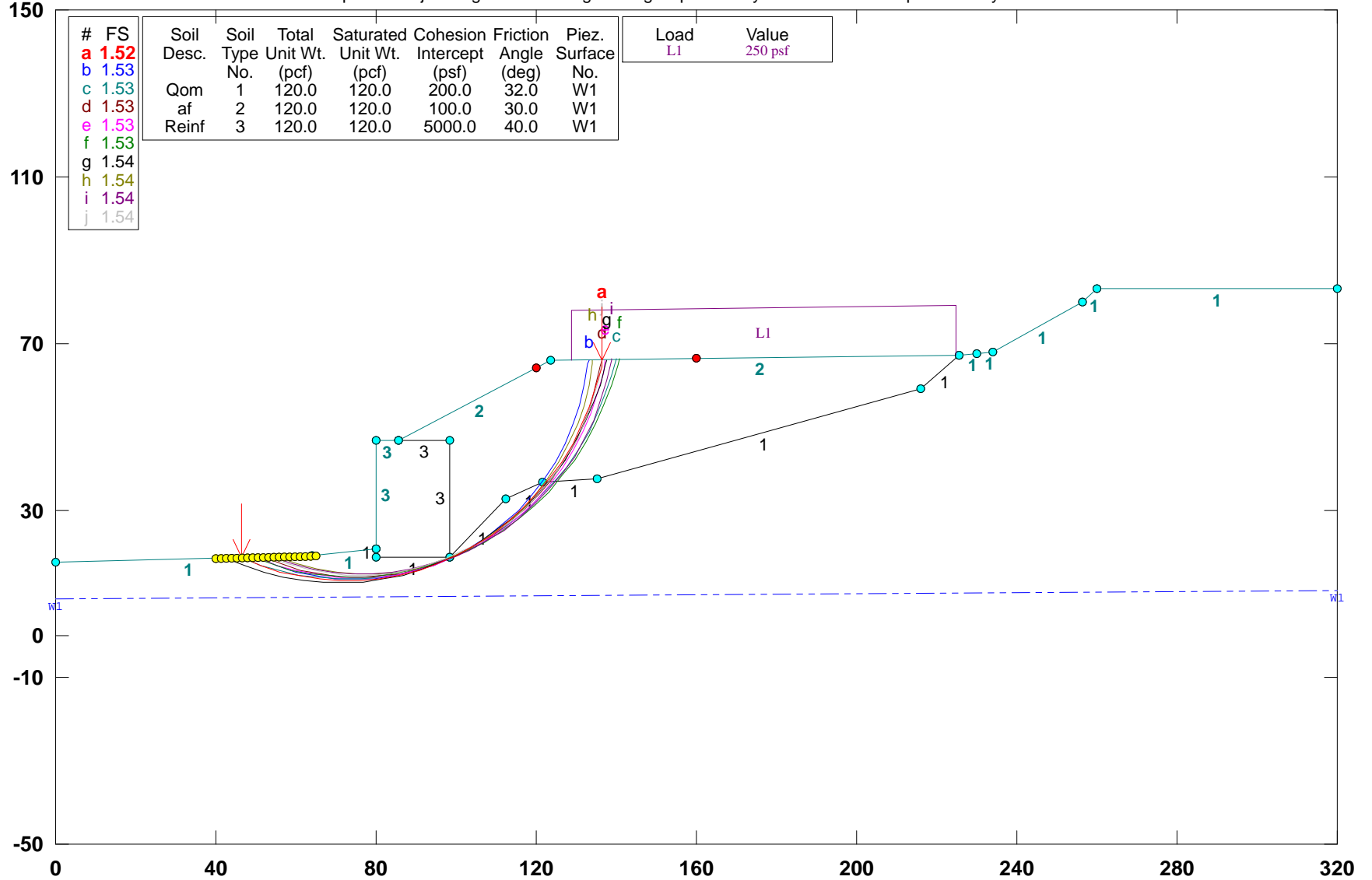

**GSTABL7 v.2 FSmin=1.52**  
**Safety Factors Are Calculated By The Modified Bishop Method**



\*\*\* GSTABL7 \*\*\*

\*\* GSTABL7 by Dr. Garry H. Gregory, Ph.D.,P.E.,D.GE \*\*
\*\* Original Version 1.0, January 1996; Current Ver. 2.005.3, Feb. 2013 \*\*
(All Rights Reserved-Unauthorized Use Prohibited)

SLOPE STABILITY ANALYSIS SYSTEM

Modified Bishop, Simplified Janbu, or GLE Method of Slices.
(Includes Spencer & Morgenstern-Price Type Analysis)
Including Pier/Pile, Reinforcement, Soil Nail, Tieback,
Nonlinear Undrained Shear Strength, Curved Phi Envelope,
Anisotropic Soil, Fiber-Reinforced Soil, Boundary Loads, Water
Surfaces, Pseudo-Static & Newmark Earthquake, and Applied Forces.

Analysis Run Date: 3/14/2019
Time of Run: 09:50AM
Run By: LGC Geotechnical
Input Data Filename: Z:\2012\12091-01 Howard Industrial Partners - John S Gibson
Blvd\Engineering\Slope Stability\Sections\H-H'\hxsx.in
Output Filename: Z:\2012\12091-01 Howard Industrial Partners - John S Gibson
Blvd\Engineering\Slope Stability\Sections\H-H'\hxsx.OUT
Unit System: English
Plotted Output Filename: Z:\2012\12091-01 Howard Industrial Partners - John S Gibson
Blvd\Engineering\Slope Stability\Sections\H-H'\hxsx.PLT
PROBLEM DESCRIPTION: 12091-01 / John S. Gibson / Sec. H-H'
MSE Wall "E" / Static

BOUNDARY COORDINATES
11 Top Boundaries
20 Total Boundaries

Table with 6 columns: Boundary No., X-Left (ft), Y-Left (ft), X-Right (ft), Y-Right (ft), Soil Type Below Bnd. Lists 20 boundary points with their respective coordinates and soil types.

Default Y-Origin = 0.00(ft)
Default X-Plus Value = 0.00(ft)
Default Y-Plus Value = 0.00(ft)

ISOTROPIC SOIL PARAMETERS

Table with 7 columns: Type of Soil, Total Unit Wt. (pcf), Saturated Unit Wt. (pcf), Cohesion (psf), Friction Angle (deg), Pore Pressure Param. (psf), Piez. Surface No. Lists 3 soil types with their parameters.

1 PIEZOMETRIC SURFACE(S) SPECIFIED

Unit Weight of Water = 62.40 (pcf)
Piezometric Surface No. 1 Specified by 2 Coordinate Points
Pore Pressure Inclination Factor = 0.50

Table with 3 columns: Point No., X-Water (ft), Y-Water (ft). Lists 2 points for piezometric surface 1.

BOUNDARY LOAD(S)

Table with 4 columns: Load No., X-Left (ft), X-Right (ft), Intensity (psf), Deflection (deg). Shows 1 load specified at X=128.60 to X=225.00 with an intensity of 250.0 psf and 0.0 deflection.

NOTE - Intensity Is Specified As A Uniformly Distributed Force Acting On A Horizontally Projected Surface.
A Critical Failure Surface Searching Method, Using A Random Technique For Generating Circular Surfaces, Has Been Specified.
5000 Trial Surfaces Have Been Generated.

250 Surface(s) Initiate(s) From Each Of 20 Points Equally Spaced Along The Ground Surface Between X = 40.00(ft) and X = 65.00(ft)
Each Surface Terminates Between X = 120.00(ft) and X = 160.00(ft)

Unless Further Limitations Were Imposed, The Minimum Elevation At Which A Surface Extends Is Y = 0.00(ft)
5.00(ft) Line Segments Define Each Trial Failure Surface.
Following Are Displayed The Ten Most Critical Of The Trial Failure Surfaces Evaluated. They Are Ordered - Most Critical First.

\* \* Safety Factors Are Calculated By The Modified Bishop Method \* \*
Total Number of Trial Surfaces Attempted = 5000
Number of Trial Surfaces With Valid FS = 5000
Statistical Data on All Valid FS Values:
FS Max = 2.871 FS Min = 1.524 FS Ave = 2.011
Standard Deviation = 0.230 Coefficient of Variation = 11.45 %
Failure Surface Specified By 25 Coordinate Points

Table with 3 columns: Point No., X-Surf (ft), Y-Surf (ft). Lists 25 failure surface points with their coordinates.

Circle Center At X = 72.571 ; Y = 78.396 ; and Radius = 65.185

Factor of Safety \*\*\* 1.524 \*\*\*

Table with 10 columns: Slice No., Width (ft), Weight (lbs), Top Force (lbs), Bot Force (lbs), Tie Norm (lbs), Tie Tan (lbs), Earthquake Force (lbs), Hor Ver Load (lbs), Surcharge (lbs). Shows individual data for 8 slices.

9	0.0	24.2	0.0	0.0	0.	0.	0.0	0.0	0.0
10	0.1	360.0	0.0	0.0	0.	0.	0.0	0.0	0.0
11	0.7	2885.0	0.0	0.0	0.	0.	0.0	0.0	0.0
12	4.8	18844.1	0.0	0.0	0.	0.	0.0	0.0	0.0
13	0.2	600.1	0.0	0.0	0.	0.	0.0	0.0	0.0
14	4.9	19300.9	0.0	0.0	0.	0.	0.0	0.0	0.0
15	4.7	19459.0	0.0	0.0	0.	0.	0.0	0.0	0.0
16	3.0	12666.7	0.0	0.0	0.	0.	0.0	0.0	0.0
17	0.0	41.9	0.0	0.0	0.	0.	0.0	0.0	0.0
18	1.6	6530.0	0.0	0.0	0.	0.	0.0	0.0	0.0
19	4.5	18655.5	0.0	0.0	0.	0.	0.0	0.0	0.0
20	4.3	17736.4	0.0	0.0	0.	0.	0.0	0.0	0.0
21	3.8	15544.1	0.0	0.0	0.	0.	0.0	0.0	0.0
22	0.2	973.8	0.0	0.0	0.	0.	0.0	0.0	0.0
23	3.8	15045.5	0.0	0.0	0.	0.	0.0	0.0	0.0
24	3.6	13372.9	0.0	0.0	0.	0.	0.0	0.0	0.0
25	1.4	4981.4	0.0	0.0	0.	0.	0.0	0.0	0.0
26	1.3	4549.1	0.0	0.0	0.	0.	0.0	0.0	0.0
27	0.6	2029.7	0.0	0.0	0.	0.	0.0	0.0	0.0
28	0.2	695.8	0.0	0.0	0.	0.	0.0	0.0	0.0
29	2.8	8752.1	0.0	0.0	0.	0.	0.0	0.0	0.0
30	2.2	6061.8	0.0	0.0	0.	0.	0.0	0.0	0.0
31	0.4	1078.1	0.0	0.0	0.	0.	0.0	109.1	0.0
32	2.3	5048.3	0.0	0.0	0.	0.	0.0	582.6	0.0
33	2.0	3232.8	0.0	0.0	0.	0.	0.0	496.1	0.0
34	1.6	1745.7	0.0	0.0	0.	0.	0.0	406.7	0.0
35	1.3	631.6	0.0	0.0	0.	0.	0.0	314.9	0.0
36	0.3	33.8	0.0	0.0	0.	0.	0.0	79.7	0.0

Failure Surface Specified By 24 Coordinate Points

Point No.	X-Surf (ft)	Y-Surf (ft)
1	50.526	18.704
2	55.167	16.843
3	59.950	15.384
4	64.839	14.337
5	69.799	13.710
6	74.795	13.508
7	79.790	13.732
8	84.748	14.379
9	89.633	15.447
10	94.409	16.926
11	99.042	18.807
12	103.498	21.074
13	107.745	23.713
14	111.752	26.704
15	115.490	30.025
16	118.932	33.652
17	122.052	37.558
18	124.829	41.716
19	127.242	46.096
20	129.273	50.664
21	130.909	55.389
22	132.136	60.236
23	132.946	65.170
24	133.021	66.129

Circle Center At X = 74.673 ; Y = 72.162 ; and Radius = 58.659

Factor of Safety

\*\*\* 1.527 \*\*\*

Failure Surface Specified By 25 Coordinate Points

Point No.	X-Surf (ft)	Y-Surf (ft)
1	46.579	18.617
2	51.277	16.906
3	56.086	15.538
4	60.981	14.520
5	65.937	13.857
6	70.928	13.553
7	75.928	13.610
8	80.910	14.027
9	85.850	14.802

10	90.721	15.930
11	95.498	17.407
12	100.156	19.224
13	104.671	21.372
14	109.020	23.840
15	113.179	26.615
16	117.127	29.682
17	120.845	33.026
18	124.311	36.629
19	127.509	40.473
20	130.422	44.537
21	133.034	48.800
22	135.333	53.241
23	137.305	57.835
24	138.941	62.560
25	139.921	66.224

Circle Center At X = 72.643 ; Y = 82.872 ; and Radius = 69.340

Factor of Safety

\*\*\* 1.527 \*\*\*

Failure Surface Specified By 24 Coordinate Points

Point No.	X-Surf (ft)	Y-Surf (ft)
1	51.842	18.732
2	56.534	17.005
3	61.351	15.664
4	66.261	14.719
5	71.231	14.175
6	76.229	14.035
7	81.222	14.302
8	86.177	14.973
9	91.061	16.043
10	95.842	17.507
11	100.489	19.353
12	104.970	21.570
13	109.257	24.143
14	113.321	27.056
15	117.136	30.289
16	120.675	33.820
17	123.917	37.627
18	126.839	41.685
19	129.422	45.966
20	131.649	50.442
21	133.506	55.085
22	134.980	59.863
23	136.062	64.744
24	136.258	66.174

Circle Center At X = 75.447 ; Y = 75.555 ; and Radius = 61.531

Factor of Safety

\*\*\* 1.528 \*\*\*

Failure Surface Specified By 24 Coordinate Points

Point No.	X-Surf (ft)	Y-Surf (ft)
1	50.526	18.704
2	55.213	16.961
3	60.022	15.593
4	64.924	14.608
5	69.889	14.013
6	74.884	13.812
7	79.881	14.005
8	84.846	14.591
9	89.750	15.567
10	94.562	16.926
11	99.251	18.661
12	103.789	20.760
13	108.148	23.211
14	112.299	25.997
15	116.218	29.102
16	119.880	32.506
17	123.262	36.189
18	126.344	40.126

19 129.105 44.295  
 20 131.529 48.668  
 21 133.601 53.219  
 22 135.307 57.918  
 23 136.638 62.738  
 24 137.303 66.188

Circle Center At X = 74.942 ; Y = 77.117 ; and Radius = 63.311

Factor of Safety

\*\*\* 1.530 \*\*\*

Failure Surface Specified By 25 Coordinate Points

Point No.	X-Surf (ft)	Y-Surf (ft)
1	49.211	18.675
2	53.932	17.029
3	58.760	15.731
4	63.671	14.789
5	68.637	14.207
6	73.632	13.988
7	78.630	14.135
8	83.604	14.645
9	88.527	15.517
10	93.374	16.745
11	98.118	18.324
12	102.735	20.244
13	107.199	22.495
14	111.488	25.066
15	115.577	27.943
16	119.447	31.110
17	123.074	34.550
18	126.442	38.246
19	129.531	42.178
20	132.325	46.325
21	134.809	50.664
22	136.971	55.172
23	138.798	59.827
24	140.281	64.602
25	140.660	66.234

Circle Center At X = 74.124 ; Y = 82.529 ; and Radius = 68.543

Factor of Safety

\*\*\* 1.531 \*\*\*

Failure Surface Specified By 26 Coordinate Points

Point No.	X-Surf (ft)	Y-Surf (ft)
1	42.632	18.531
2	47.271	16.666
3	52.033	15.144
4	56.894	13.972
5	61.827	13.156
6	66.806	12.702
7	71.806	12.611
8	76.798	12.884
9	81.758	13.520
10	86.658	14.515
11	91.472	15.863
12	96.176	17.558
13	100.744	19.591
14	105.153	21.951
15	109.377	24.625
16	113.396	27.599
17	117.189	30.858
18	120.733	34.384
19	124.013	38.159
20	127.008	42.162
21	129.705	46.372
22	132.088	50.768
23	134.145	55.325
24	135.865	60.020
25	137.240	64.827
26	137.524	66.191

Circle Center At X = 70.554 ; Y = 81.233 ; and Radius = 68.638

Factor of Safety  
 \*\*\* 1.535 \*\*\*  
 Failure Surface Specified By 23 Coordinate Points

Point No.	X-Surf (ft)	Y-Surf (ft)
1	55.789	18.818
2	60.498	17.137
3	65.336	15.875
4	70.266	15.042
5	75.251	14.645
6	80.251	14.687
7	85.227	15.168
8	90.143	16.084
9	94.959	17.427
10	99.639	19.188
11	104.146	21.352
12	108.446	23.904
13	112.505	26.824
14	116.292	30.088
15	119.779	33.672
16	122.937	37.548
17	125.743	41.686
18	128.176	46.055
19	130.215	50.620
20	131.846	55.346
21	133.056	60.198
22	133.836	65.137
23	133.905	66.142

Circle Center At X = 77.272 ; Y = 71.534 ; and Radius = 56.925

Factor of Safety

\*\*\* 1.535 \*\*\*

Failure Surface Specified By 24 Coordinate Points

Point No.	X-Surf (ft)	Y-Surf (ft)
1	54.474	18.790
2	59.217	17.210
3	64.071	16.009
4	69.005	15.196
5	73.987	14.776
6	78.987	14.751
7	83.973	15.122
8	88.915	15.885
9	93.780	17.037
10	98.539	18.570
11	103.163	20.474
12	107.621	22.738
13	111.886	25.347
14	115.931	28.286
15	119.732	31.534
16	123.264	35.074
17	126.505	38.881
18	129.435	42.933
19	132.035	47.203
20	134.289	51.666
21	136.184	56.293
22	137.707	61.056
23	138.848	65.924
24	138.892	66.210

Circle Center At X = 76.803 ; Y = 77.890 ; and Radius = 63.178

Factor of Safety

\*\*\* 1.535 \*\*\*

Failure Surface Specified By 23 Coordinate Points

Point No.	X-Surf (ft)	Y-Surf (ft)
1	53.158	18.761
2	57.880	17.118
3	62.720	15.863
4	67.646	15.004
5	72.625	14.548
6	77.625	14.497

7	82.612	14.852
8	87.554	15.609
9	92.419	16.765
10	97.174	18.312
11	101.787	20.239
12	106.230	22.533
13	110.471	25.181
14	114.485	28.163
15	118.243	31.461
16	121.721	35.053
17	124.896	38.915
18	127.748	43.022
19	130.258	47.347
20	132.409	51.860
21	134.186	56.534
22	135.579	61.336
23	136.567	66.178

Circle Center At X = 75.753 ; Y = 76.086 ; and Radius = 61.617  
Factor of Safety  
\*\*\* 1.538 \*\*\*  
\*\*\*\* END OF GSTABL7 OUTPUT \*\*\*\*

# 12091-01 / John S. Gibson / Sec. H-H' MSE Wall "E" / Seismic

z:\2012\12091-01 howard industrial partners - john s gibson blvd\engineering\slope stability\sections\h-h'\hxsxe.pl2 Run By: LGC Geotechnical 3/14/2019 09:53AM

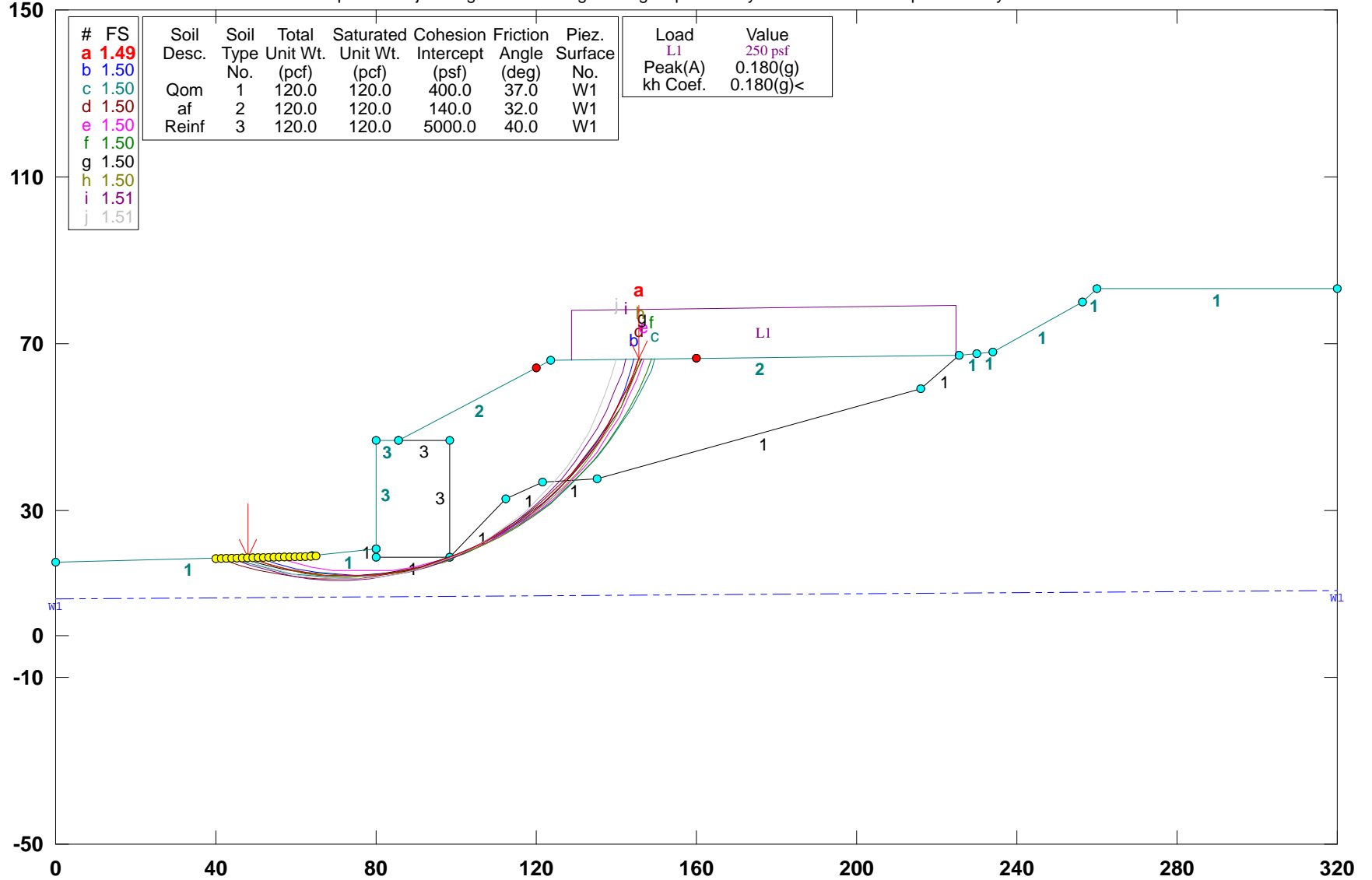

GSTABL7 v.2 FSmin=1.49  
Safety Factors Are Calculated By The Modified Bishop Method

\*\*\* GSTABL7 \*\*\*

\*\* GSTABL7 by Dr. Garry H. Gregory, Ph.D., P.E., D.GE \*\*  
 \*\* Original Version 1.0, January 1996; Current Ver. 2.005.3, Feb. 2013 \*\*  
 (All Rights Reserved-Unauthorised Use Prohibited)

SLOPE STABILITY ANALYSIS SYSTEM

Modified Bishop, Simplified Janbu, or GLE Method of Slices.  
 (Includes Spencer & Morgenstern-Price Type Analysis)  
 Including Pier/Pile, Reinforcement, Soil Nail, Tieback,  
 Nonlinear Undrained Shear Strength, Curved Phi Envelope,  
 Anisotropic Soil, Fiber-Reinforced Soil, Boundary Loads, Water  
 Surfaces, Pseudo-Static & Newmark Earthquake, and Applied Forces.

\*\*\*\*\*  
 Analysis Run Date: 3/14/2019  
 Time of Run: 09:53AM  
 Run By: LGC Geotechnical  
 Input Data Filename: Z:\2012\12091-01 Howard Industrial Partners - John S Gibson  
 Blvd\Engineering\Slope Stability\Sections\H-H'\hxsxe.in  
 Output Filename: Z:\2012\12091-01 Howard Industrial Partners - John S Gibson  
 Blvd\Engineering\Slope Stability\Sections\H-H'\hxsxe.OUT  
 Unit System: English  
 Plotted Output Filename: Z:\2012\12091-01 Howard Industrial Partners - John S Gibson  
 Blvd\Engineering\Slope Stability\Sections\H-H'\hxsxe.PLT  
 PROBLEM DESCRIPTION: 12091-01 / John S. Gibson / Sec. H-H'  
 MSE Wall "E" / Seismic

BOUNDARY COORDINATES

11 Top Boundaries					
20 Total Boundaries					
Boundary No.	X-Left (ft)	Y-Left (ft)	X-Right (ft)	Y-Right (ft)	Soil Type Below Bnd
1	0.00	17.60	64.10	19.00	1
2	64.10	19.00	80.00	20.70	1
3	80.00	20.70	80.01	47.00	3
4	80.01	47.00	85.60	47.00	3
5	85.60	47.00	123.60	66.00	2
6	123.60	66.00	225.50	67.40	2
7	225.50	67.40	230.00	67.50	1
8	230.00	67.50	233.80	68.00	1
9	233.80	68.00	256.40	80.00	1
10	256.40	80.00	260.00	83.00	1
11	260.00	83.00	320.00	83.00	1
12	85.60	47.00	98.40	47.00	3
13	98.40	47.00	98.41	18.70	3
14	98.41	18.70	112.50	32.70	1
15	112.50	32.70	121.50	36.80	1
16	121.50	36.80	135.20	37.80	1
17	135.20	37.80	216.00	59.10	1
18	216.00	59.10	225.50	67.40	1
19	80.00	20.70	80.10	18.70	1
20	80.10	18.70	98.41	18.70	1

Default Y-Origin = 0.00(ft)  
 Default X-Plus Value = 0.00(ft)  
 Default Y-Plus Value = 0.00(ft)

ISOTROPIC SOIL PARAMETERS

3 Type(s) of Soil							
Soil Type No.	Total Unit Wt. (pcf)	Saturated Unit Wt. (pcf)	Cohesion (psf)	Friction Angle (deg)	Pore Pressure Param. (psf)	Pressure Constant	Piez. Surface
1	120.0	120.0	400.0	37.0	0.00	0.0	1
2	120.0	120.0	140.0	32.0	0.00	0.0	1
3	120.0	120.0	5000.0	40.0	0.00	0.0	1

1 PIEZOMETRIC SURFACE(S) SPECIFIED

Unit Weight of Water = 62.40 (pcf)  
 Piezometric Surface No. 1 Specified by 2 Coordinate Points  
 Pore Pressure Inclination Factor = 0.50

Point No.	X-Water (ft)	Y-Water (ft)
1	0.00	8.80
2	320.00	10.70

BOUNDARY LOAD(S)

1 Load(s) Specified

Load No.	X-Left (ft)	X-Right (ft)	Intensity (psf)	Deflection (deg)
1	128.60	225.00	250.0	0.0

NOTE - Intensity Is Specified As A Uniformly Distributed Force Acting On A Horizontally Projected Surface.

Specified Peak Ground Acceleration Coefficient (A) = 0.180(g)  
 Specified Horizontal Earthquake Coefficient (kh) = 0.180(g)  
 Specified Vertical Earthquake Coefficient (kv) = 0.000(g)  
 Specified Seismic Pore-Pressure Factor = 0.000

A Critical Failure Surface Searching Method, Using A Random Technique For Generating Circular Surfaces, Has Been Specified.  
 5000 Trial Surfaces Have Been Generated.

250 Surface(s) Initiate(s) From Each Of 20 Points Equally Spaced Along The Ground Surface Between X = 40.00(ft) and X = 65.00(ft)

Each Surface Terminates Between X = 120.00(ft) and X = 160.00(ft)

Unless Further Limitations Were Imposed, The Minimum Elevation At Which A Surface Extends Is Y = 0.00(ft)

5.00(ft) Line Segments Define Each Trial Failure Surface. Following Are Displayed The Ten Most Critical Of The Trial Failure Surfaces Evaluated. They Are Ordered - Most Critical First.

\* \* Safety Factors Are Calculated By The Modified Bishop Method \* \*  
 Total Number of Trial Surfaces Attempted = 5000  
 Number of Trial Surfaces With Valid FS = 5000  
 Statistical Data on All Valid FS Values:  
 FS Max = 2.504 FS Min = 1.493 FS Ave = 1.893  
 Standard Deviation = 0.203 Coefficient of Variation = 10.71 %  
 Failure Surface Specified By 26 Coordinate Points

Point No.	X-Surf (ft)	Y-Surf (ft)
1	47.895	18.646
2	52.666	17.151
3	57.525	15.971
4	62.450	15.111
5	67.421	14.576
6	72.417	14.367
7	77.416	14.485
8	82.396	14.930
9	87.336	15.701
10	92.216	16.792
11	97.013	18.201
12	101.708	19.920
13	106.281	21.943
14	110.711	24.261
15	114.980	26.864
16	119.070	29.741
17	122.962	32.879
18	126.641	36.264
19	130.091	39.884
20	133.296	43.721
21	136.244	47.760
22	138.921	51.983
23	141.315	56.372
24	143.418	60.909
25	145.219	65.573
26	145.446	66.300

Circle Center At X = 73.112 ; Y = 90.700 ; and Radius = 76.339

Factor of Safety

\*\*\* 1.493 \*\*\*

Individual data on the 39 slices

Slice No.	Width (ft)	Weight (lbs)	Water Force (lbs)	Tie Force (lbs)	Tie Force Norm (lbs)	Earthquake Force (lbs)	Surcharge (lbs)	Piezometric Surface	
								Hor (lbs)	Ver (lbs)
1	4.8	457.9	0.0	0.0	0.0	0.0	0.0	82.4	0.0
2	4.9	1307.5	0.0	0.0	0.0	0.0	0.0	235.4	0.0
3	4.9	1991.4	0.0	0.0	0.0	0.0	0.0	358.5	0.0

4	1.6	783.9	0.0	0.0	0.	0.	141.1	0.0	0.0
5	3.3	1762.8	0.0	0.0	0.	0.	317.3	0.0	0.0
6	5.0	3087.8	0.0	0.0	0.	0.	555.8	0.0	0.0
7	5.0	3437.3	0.0	0.0	0.	0.	618.7	0.0	0.0
8	2.6	1848.6	0.0	0.0	0.	0.	332.7	0.0	0.0
9	0.0	23.0	0.0	0.0	0.	0.	4.1	0.0	0.0
10	0.1	348.6	0.0	0.0	0.	0.	62.7	0.0	0.0
11	2.3	8863.5	0.0	0.0	0.	0.	1595.4	0.0	0.0
12	3.2	12234.6	0.0	0.0	0.	0.	2202.2	0.0	0.0
13	1.7	6639.6	0.0	0.0	0.	0.	1195.1	0.0	0.0
14	4.9	19229.5	0.0	0.0	0.	0.	3461.3	0.0	0.0
15	4.8	19579.8	0.0	0.0	0.	0.	3524.4	0.0	0.0
16	1.4	5658.2	0.0	0.0	0.	0.	1018.5	0.0	0.0
17	0.0	100.2	0.0	0.0	0.	0.	18.0	0.0	0.0
18	0.0	41.6	0.0	0.0	0.	0.	7.5	0.0	0.0
19	0.0	82.8	0.0	0.0	0.	0.	14.9	0.0	0.0
20	3.3	13734.6	0.0	0.0	0.	0.	2472.2	0.0	0.0
21	4.6	19349.9	0.0	0.0	0.	0.	3483.0	0.0	0.0
22	4.4	18790.9	0.0	0.0	0.	0.	3382.4	0.0	0.0
23	1.8	7556.7	0.0	0.0	0.	0.	1360.2	0.0	0.0
24	2.5	10404.4	0.0	0.0	0.	0.	1872.8	0.0	0.0
25	4.1	16887.2	0.0	0.0	0.	0.	3039.7	0.0	0.0
26	2.4	9805.8	0.0	0.0	0.	0.	1765.0	0.0	0.0
27	1.5	5795.5	0.0	0.0	0.	0.	1043.2	0.0	0.0
28	0.6	2499.8	0.0	0.0	0.	0.	450.0	0.0	0.0
29	3.0	11370.8	0.0	0.0	0.	0.	2046.7	0.0	0.0
30	0.9	3279.6	0.0	0.0	0.	0.	590.3	0.0	0.0
31	1.0	3480.8	0.0	0.0	0.	0.	626.5	0.0	0.0
32	1.5	4826.7	0.0	0.0	0.	0.	868.8	0.0	372.7
33	3.2	9350.2	0.0	0.0	0.	0.	1683.0	0.0	801.3
34	2.9	7219.8	0.0	0.0	0.	0.	1299.6	0.0	736.9
35	2.7	5242.5	0.0	0.0	0.	0.	943.6	0.0	669.2
36	2.4	3462.6	0.0	0.0	0.	0.	623.3	0.0	598.7
37	2.1	1921.8	0.0	0.0	0.	0.	345.9	0.0	525.6
38	1.8	657.8	0.0	0.0	0.	0.	118.4	0.0	450.3
39	0.2	9.9	0.0	0.0	0.	0.	1.8	0.0	56.8

Failure Surface Specified By 25 Coordinate Points

Point No.	X-Surf (ft)	Y-Surf (ft)
1	50.526	18.704
2	55.298	17.210
3	60.160	16.045
4	65.091	15.216
5	70.067	14.726
6	75.065	14.578
7	80.061	14.771
8	85.033	15.305
9	89.956	16.178
10	94.808	17.386
11	99.566	18.922
12	104.208	20.780
13	108.712	22.951
14	113.057	25.425
15	117.223	28.190
16	121.190	31.234
17	124.939	34.542
18	128.454	38.098
19	131.718	41.886
20	134.714	45.888
21	137.431	50.086
22	139.854	54.460
23	141.972	58.989
24	143.775	63.652
25	144.593	66.288

Circle Center At X = 74.739 ; Y = 87.673 ; and Radius = 73.096

Factor of Safety  
\*\*\* 1.498 \*\*\*

Failure Surface Specified By 27 Coordinate Points

Point No.	X-Surf (ft)	Y-Surf (ft)
-----------	-------------	-------------

1	43.947	18.560
2	48.726	17.087
3	53.582	15.898
4	58.500	14.997
5	63.463	14.386
6	68.453	14.069
7	73.453	14.046
8	78.445	14.318
9	83.413	14.882
10	88.339	15.738
11	93.207	16.883
12	97.998	18.312
13	102.697	20.020
14	107.288	22.002
15	111.753	24.251
16	116.079	26.759
17	120.250	29.517
18	124.251	32.515
19	128.068	35.744
20	131.689	39.192
21	135.101	42.847
22	138.292	46.697
23	141.251	50.727
24	143.967	54.925
25	146.432	59.275
26	148.636	63.763
27	149.727	66.359

Circle Center At X = 71.342 ; Y = 98.943 ; and Radius = 84.923

Factor of Safety  
\*\*\* 1.500 \*\*\*

Failure Surface Specified By 27 Coordinate Points

Point No.	X-Surf (ft)	Y-Surf (ft)
1	41.316	18.502
2	46.055	16.909
3	50.883	15.610
4	55.782	14.611
5	60.734	13.915
6	65.719	13.525
7	70.718	13.443
8	75.713	13.668
9	80.684	14.201
10	85.614	15.039
11	90.482	16.178
12	95.271	17.615
13	99.963	19.344
14	104.539	21.359
15	108.982	23.651
16	113.276	26.213
17	117.405	29.034
18	121.351	32.103
19	125.102	35.410
20	128.641	38.942
21	131.957	42.684
22	135.036	46.624
23	137.867	50.745
24	140.438	55.033
25	142.741	59.472
26	144.766	64.043
27	145.605	66.302

Circle Center At X = 69.552 ; Y = 94.630 ; and Radius = 81.195

Factor of Safety  
\*\*\* 1.500 \*\*\*

Failure Surface Specified By 25 Coordinate Points

Point No.	X-Surf (ft)	Y-Surf (ft)
1	54.474	18.790
2	59.291	17.450
3	64.188	16.440
4	69.142	15.763

5	74.130	15.424
6	79.130	15.423
7	84.119	15.762
8	89.073	16.437
9	93.970	17.446
10	98.788	18.784
11	103.503	20.446
12	108.096	22.424
13	112.544	24.707
14	116.827	27.287
15	120.925	30.151
16	124.820	33.286
17	128.494	36.678
18	131.930	40.311
19	135.111	44.168
20	138.024	48.232
21	140.656	52.483
22	142.993	56.903
23	145.025	61.472
24	146.743	66.167
25	146.788	66.319

Circle Center At X = 76.639 ; Y = 89.160 ; and Radius = 73.779  
 Factor of Safety  
 \*\*\* 1.501 \*\*\*

Failure Surface Specified By 26 Coordinate Points

Point No.	X-Surf (ft)	Y-Surf (ft)
1	47.895	18.646
2	52.683	17.206
3	57.551	16.064
4	62.480	15.226
5	67.452	14.695
6	72.447	14.472
7	77.446	14.558
8	82.430	14.954
9	87.381	15.657
10	92.278	16.665
11	97.104	17.974
12	101.839	19.579
13	106.466	21.474
14	110.967	23.652
15	115.324	26.104
16	119.522	28.820
17	123.543	31.791
18	127.373	35.006
19	130.997	38.451
20	134.401	42.113
21	137.571	45.980
22	140.497	50.034
23	143.166	54.263
24	145.568	58.648
25	147.694	63.173
26	148.953	66.348

Circle Center At X = 73.553 ; Y = 95.187 ; and Radius = 80.727  
 Factor of Safety  
 \*\*\* 1.501 \*\*\*

Failure Surface Specified By 26 Coordinate Points

Point No.	X-Surf (ft)	Y-Surf (ft)
1	46.579	18.617
2	51.355	17.139
3	56.216	15.967
4	61.141	15.106
5	66.112	14.560
6	71.106	14.330
7	76.105	14.418
8	81.089	14.823
9	86.037	15.544
10	90.929	16.578
11	95.745	17.920

12	100.467	19.565
13	105.075	21.507
14	109.550	23.737
15	113.874	26.247
16	118.030	29.026
17	122.001	32.064
18	125.772	35.348
19	129.326	38.865
20	132.650	42.600
21	135.730	46.539
22	138.554	50.665
23	141.109	54.963
24	143.387	59.414
25	145.378	64.000
26	146.211	66.311

Circle Center At X = 72.227 ; Y = 92.952 ; and Radius = 78.634  
 Factor of Safety  
 \*\*\* 1.501 \*\*\*

Failure Surface Specified By 26 Coordinate Points

Point No.	X-Surf (ft)	Y-Surf (ft)
1	47.895	18.646
2	52.652	17.107
3	57.500	15.882
4	62.417	14.978
5	67.383	14.398
6	72.377	14.145
7	77.376	14.220
8	82.360	14.622
9	87.307	15.349
10	92.196	16.400
11	97.005	17.768
12	101.714	19.449
13	106.303	21.434
14	110.751	23.716
15	115.041	26.285
16	119.154	29.129
17	123.071	32.236
18	126.776	35.594
19	130.253	39.187
20	133.487	43.000
21	136.464	47.017
22	139.172	51.221
23	141.598	55.592
24	143.733	60.114
25	145.566	64.765
26	146.061	66.309

Circle Center At X = 73.743 ; Y = 90.331 ; and Radius = 76.203  
 Factor of Safety  
 \*\*\* 1.504 \*\*\*

Failure Surface Specified By 26 Coordinate Points

Point No.	X-Surf (ft)	Y-Surf (ft)
1	43.947	18.560
2	48.651	16.865
3	53.459	15.492
4	58.348	14.445
5	63.297	13.730
6	68.283	13.351
7	73.282	13.308
8	78.274	13.603
9	83.234	14.233
10	88.140	15.196
11	92.970	16.488
12	97.703	18.102
13	102.315	20.032
14	106.788	22.268
15	111.099	24.800
16	115.230	27.617
17	119.161	30.706



18	122.875	34.053
19	126.356	37.643
20	129.586	41.460
21	132.552	45.485
22	135.240	49.701
23	137.638	54.089
24	139.734	58.628
25	141.520	63.298
26	142.428	66.259

Circle Center At X = 71.415 ; Y = 87.362 ; and Radius = 74.082

Factor of Safety  
\*\*\* 1.506 \*\*\*

Failure Surface Specified By 25 Coordinate Points

Point No.	X-Surf (ft)	Y-Surf (ft)
1	46.579	18.617
2	51.277	16.906
3	56.086	15.538
4	60.981	14.520
5	65.937	13.857
6	70.928	13.553
7	75.928	13.610
8	80.910	14.027
9	85.850	14.802
10	90.721	15.930
11	95.498	17.407
12	100.156	19.224
13	104.671	21.372
14	109.020	23.840
15	113.179	26.615
16	117.127	29.682
17	120.845	33.026
18	124.311	36.629
19	127.509	40.473
20	130.422	44.537
21	133.034	48.800
22	135.333	53.241
23	137.305	57.835
24	138.941	62.560
25	139.921	66.224

Circle Center At X = 72.643 ; Y = 82.872 ; and Radius = 69.340

Factor of Safety  
\*\*\* 1.507 \*\*\*

\*\*\*\* END OF GSTABL7 OUTPUT \*\*\*\*

# 12091-01 / John S. Gibson / Sec. I-' MSE Wall "E" / Static

z:\2012\12091-01 howard industrial partners - john s gibson blvd\engineering\slope stability\sections\i-i'\ixs.pl2 Run By: LGC Geotechnical 3/14/2019 08:15AM

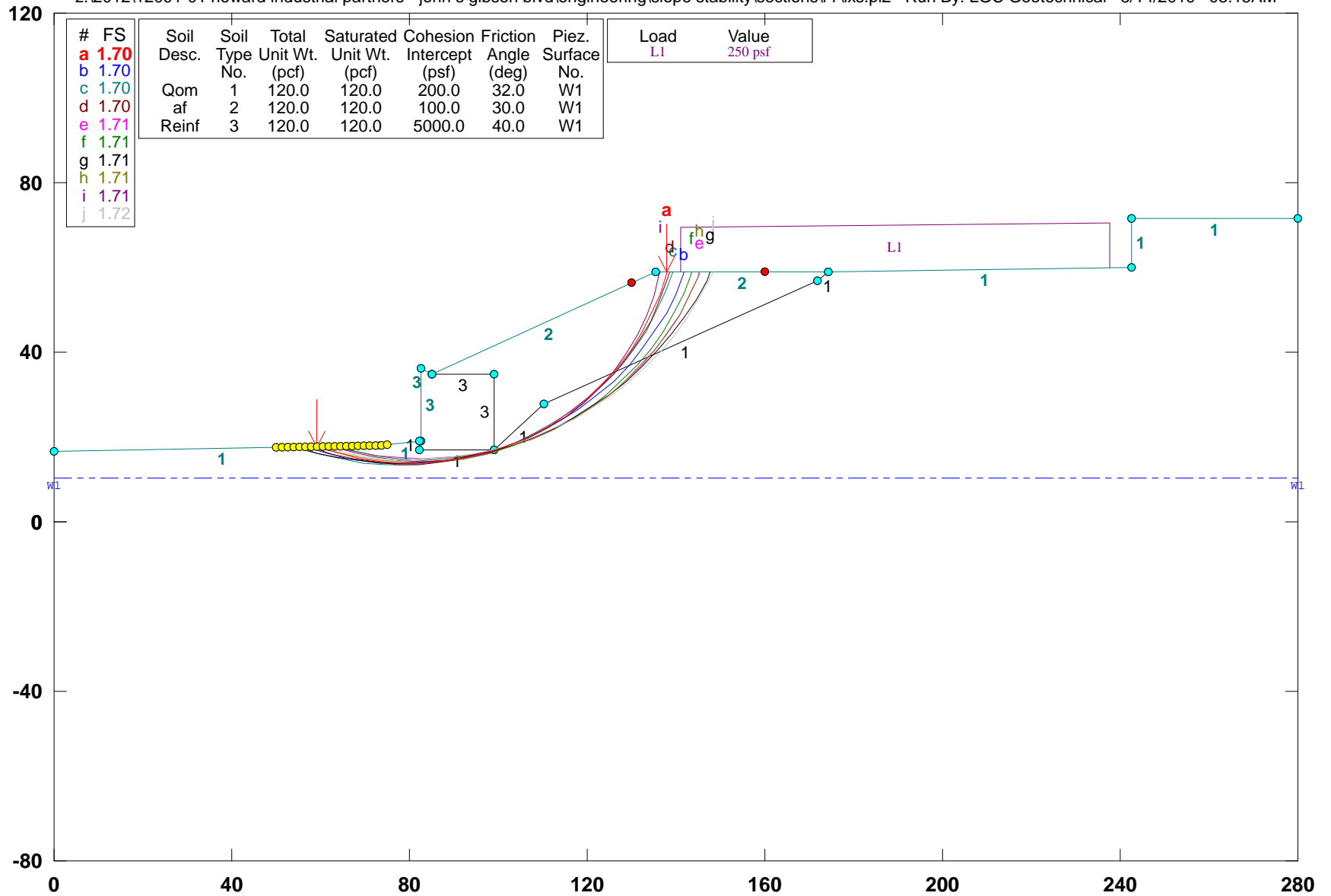

GSTABL7 v.2 FSmin=1.70  
Safety Factors Are Calculated By The Modified Bishop Method

\*\*\* GSTABL7 \*\*\*

\*\* GSTABL7 by Dr. Garry H. Gregory, Ph.D., P.E., D.GE \*\*

\*\* Original Version 1.0, January 1996; Current Ver. 2.005.3, Feb. 2013 \*\*  
 (All Rights Reserved-Unauthorized Use Prohibited)

\*\*\*\*\*  
 SLOPE STABILITY ANALYSIS SYSTEM  
 Modified Bishop, Simplified Janbu, or GLE Method of Slices.  
 (Includes Spencer & Morgenstern-Price Type Analysis)  
 Including Pier/Pile, Reinforcement, Soil Nail, Tieback,  
 Nonlinear Undrained Shear Strength, Curved Phi Envelope,  
 Anisotropic Soil, Fiber-Reinforced Soil, Boundary Loads, Water  
 Surfaces, Pseudo-Static & Newmark Earthquake, and Applied Forces.  
 \*\*\*\*\*  
 Analysis Run Date: 3/14/2019  
 Time of Run: 08:15AM  
 Run By: LGC Geotechnical  
 Input Data Filename: Z:\2012\12091-01 Howard Industrial Partners - John S Gibson  
 Blvd\Engineering\Slope Stability\Sections\I-I'\ixs.in  
 Output Filename: Z:\2012\12091-01 Howard Industrial Partners - John S Gibson  
 Blvd\Engineering\Slope Stability\Sections\I-I'\ixs.OUT  
 Unit System: English  
 Plotted Output Filename: Z:\2012\12091-01 Howard Industrial Partners - John S Gibson  
 Blvd\Engineering\Slope Stability\Sections\I-I'\ixs.PLT  
 PROBLEM DESCRIPTION: 12091-01 / John S. Gibson / Sec. I-I'  
 MSE Wall "E" / Static

BOUNDARY COORDINATES

Boundary No.	X-Left (ft)	Y-Left (ft)	X-Right (ft)	Y-Right (ft)	Soil Type Below Bnd
1	0.00	16.60	73.50	18.00	1
2	73.50	18.00	82.50	19.00	1
3	82.50	19.00	82.51	36.10	3
4	82.51	36.10	85.20	34.90	3
5	85.20	34.90	135.40	59.00	2
6	135.40	59.00	174.30	59.00	2
7	174.30	59.00	242.50	60.00	1
8	242.50	60.00	242.51	71.40	1
9	242.51	71.40	280.00	71.40	1
10	85.20	34.90	99.10	34.90	3
11	99.10	34.90	99.11	17.00	3
12	99.11	17.00	110.10	27.90	1
13	110.10	27.90	171.90	57.00	1
14	171.90	57.00	174.30	59.00	1
15	82.10	19.00	82.11	17.00	1
16	82.11	17.00	99.11	17.00	1

Default Y-Origin = 0.00(ft)  
 Default X-Plus Value = 0.00(ft)  
 Default Y-Plus Value = 0.00(ft)

ISOTROPIC SOIL PARAMETERS

3 Type(s) of Soil	Type	Unit Wt. (pcf)	Saturated Unit Wt. (pcf)	Cohesion (psf)	Friction Angle (deg)	Pore Pressure Param. (psf)	Pressure Constant	Piez. Surface No.
1	120.0	120.0	200.0	32.0	0.00	0.0	0.0	1
2	120.0	120.0	100.0	30.0	0.00	0.0	0.0	1
3	120.0	120.0	5000.0	40.0	0.00	0.0	0.0	1

1 PIEZOMETRIC SURFACE(S) SPECIFIED

Unit Weight of Water = 62.70 (pcf)  
 Piezometric Surface No. 1 Specified by 2 Coordinate Points

Pore Pressure Inclination Factor = 0.50

Point No.	X-Water (ft)	Y-Water (ft)
1	0.00	10.20
2	280.00	10.20

BOUNDARY LOAD(S)

1 Load(s) Specified

Load No.	X-Left (ft)	X-Right (ft)	Intensity (psf)	Deflection (deg)
1	140.90	237.50	250.0	0.0

NOTE - Intensity Is Specified As A Uniformly Distributed

Force Acting On A Horizontally Projected Surface.  
 A Critical Failure Surface Searching Method, Using A Random  
 Technique For Generating Circular Surfaces, Has Been Specified.  
 5000 Trial Surfaces Have Been Generated.

250 Surface(s) Initiate(s) From Each Of 20 Points Equally Spaced  
 Along The Ground Surface Between X = 50.00(ft)  
 and X = 75.00(ft)  
 Each Surface Terminates Between X = 130.00(ft)  
 and X = 160.00(ft)

Unless Further Limitations Were Imposed, The Minimum Elevation  
 At Which A Surface Extends Is Y = 0.00(ft)  
 5.00(ft) Line Segments Define Each Trial Failure Surface.  
 Following Are Displayed The Ten Most Critical Of The Trial  
 Failure Surfaces Evaluated. They Are

Ordered - Most Critical First.  
 \* \* Safety Factors Are Calculated By The Modified Bishop Method \* \*

Total Number of Trial Surfaces Attempted = 5000  
 Number of Trial Surfaces With Valid FS = 5000  
 Statistical Data on All Valid FS Values:  
 FS Max = 3.617 FS Min = 1.697 FS Ave = 2.236  
 Standard Deviation = 0.294 Coefficient of Variation = 13.17 %  
 Failure Surface Specified By 22 Coordinate Points

Point No.	X-Surf (ft)	Y-Surf (ft)
1	59.211	17.728
2	63.956	16.151
3	68.816	14.980
4	73.758	14.222
5	78.747	13.882
6	83.746	13.963
7	88.721	14.464
8	93.636	15.383
9	98.456	16.711
10	103.148	18.441
11	107.677	20.559
12	112.012	23.051
13	116.122	25.898
14	119.977	29.082
15	123.551	32.578
16	126.819	36.363
17	129.756	40.409
18	132.342	44.688
19	134.559	49.170
20	136.391	53.822
21	137.825	58.612
22	137.907	59.000

Circle Center At X = 80.286 ; Y = 73.206 ; and Radius = 59.347  
 Factor of Safety = 1.697

\*\*\* 1.697 \*\*\*

Individual data on the 32 slices

Slice No.	Width (ft)	Weight (lbs)	Water Force Top (lbs)	Water Force Bot (lbs)	Tie Force Norm (lbs)	Tie Force Tan (lbs)	Earthquake Force Hor (lbs)	Surcharge Ver (lbs)	Surcharge Load (lbs)
1	4.7	474.5	0.0	0.0	0.0	0.0	0.0	0.0	0.0
2	4.9	1340.9	0.0	0.0	0.0	0.0	0.0	0.0	0.0
3	4.7	1874.3	0.0	0.0	0.0	0.0	0.0	0.0	0.0
4	0.3	117.0	0.0	0.0	0.0	0.0	0.0	0.0	0.0
5	5.0	2546.6	0.0	0.0	0.0	0.0	0.0	0.0	0.0
6	3.4	1955.7	0.0	0.0	0.0	0.0	0.0	0.0	0.0
7	0.0	6.0	0.0	0.0	0.0	0.0	0.0	0.0	0.0
8	0.4	235.8	0.0	0.0	0.0	0.0	0.0	0.0	0.0
9	0.0	16.3	0.0	0.0	0.0	0.0	0.0	0.0	0.0
10	1.2	3244.7	0.0	0.0	0.0	0.0	0.0	0.0	0.0
11	1.5	3696.2	0.0	0.0	0.0	0.0	0.0	0.0	0.0
12	3.5	9066.7	0.0	0.0	0.0	0.0	0.0	0.0	0.0
13	4.9	13474.8	0.0	0.0	0.0	0.0	0.0	0.0	0.0
14	4.8	13917.0	0.0	0.0	0.0	0.0	0.0	0.0	0.0
15	0.6	1899.5	0.0	0.0	0.0	0.0	0.0	0.0	0.0

16	0.0	29.6	0.0	0.0	0.	0.	0.0	0.0	0.0
17	4.0	12040.3	0.0	0.0	0.	0.	0.0	0.0	0.0
18	4.5	13643.9	0.0	0.0	0.	0.	0.0	0.0	0.0
19	2.4	7274.6	0.0	0.0	0.	0.	0.0	0.0	0.0
20	1.9	5691.9	0.0	0.0	0.	0.	0.0	0.0	0.0
21	4.1	11976.4	0.0	0.0	0.	0.	0.0	0.0	0.0
22	3.9	10725.1	0.0	0.0	0.	0.	0.0	0.0	0.0
23	3.6	9274.4	0.0	0.0	0.	0.	0.0	0.0	0.0
24	2.4	5755.8	0.0	0.0	0.	0.	0.0	0.0	0.0
25	0.9	1938.8	0.0	0.0	0.	0.	0.0	0.0	0.0
26	2.9	6062.1	0.0	0.0	0.	0.	0.0	0.0	0.0
27	2.6	4457.4	0.0	0.0	0.	0.	0.0	0.0	0.0
28	2.2	2962.4	0.0	0.0	0.	0.	0.0	0.0	0.0
29	0.8	863.7	0.0	0.0	0.	0.	0.0	0.0	0.0
30	1.0	765.7	0.0	0.0	0.	0.	0.0	0.0	0.0
31	1.4	478.9	0.0	0.0	0.	0.	0.0	0.0	0.0
32	0.1	1.9	0.0	0.0	0.	0.	0.0	0.0	0.0

Failure Surface Specified By 23 Coordinate Points

Point X-Surf Y-Surf

No.	(ft)	(ft)
1	56.579	17.678
2	61.344	16.162
3	66.209	15.010
4	71.147	14.228
5	76.131	13.820
6	81.131	13.790
7	86.119	14.137
8	91.066	14.859
9	95.945	15.952
10	100.728	17.410
11	105.387	19.224
12	109.896	21.385
13	114.229	23.880
14	118.362	26.694
15	122.271	29.812
16	125.933	33.216
17	129.329	36.887
18	132.437	40.803
19	135.242	44.942
20	137.726	49.281
21	139.876	53.795
22	141.680	58.459
23	141.844	59.000

Circle Center At X = 79.032 ; Y = 80.006 ; and Radius = 66.250

Factor of Safety  
\*\*\* 1.697 \*\*\*

Failure Surface Specified By 23 Coordinate Points

Point X-Surf Y-Surf

No.	(ft)	(ft)
1	55.263	17.653
2	59.994	16.036
3	64.838	14.795
4	69.764	13.938
5	74.742	13.470
6	79.742	13.395
7	84.732	13.712
8	89.681	14.420
9	94.560	15.514
10	99.338	16.987
11	103.986	18.831
12	108.474	21.034
13	112.776	23.583
14	116.865	26.461
15	120.715	29.651
16	124.302	33.133
17	127.606	36.887
18	130.605	40.887
19	133.280	45.111
20	135.616	49.532
21	137.598	54.123

22	139.213	58.855
23	139.250	59.000

Circle Center At X = 78.202 ; Y = 77.039 ; and Radius = 63.663  
Factor of Safety  
\*\*\* 1.701 \*\*\*

Failure Surface Specified By 22 Coordinate Points

Point X-Surf Y-Surf

No.	(ft)	(ft)
1	57.895	17.703
2	62.621	16.072
3	67.467	14.838
4	72.397	14.008
5	77.380	13.589
6	82.380	13.583
7	87.363	13.990
8	92.296	14.809
9	97.144	16.032
10	101.874	17.651
11	106.454	19.656
12	110.853	22.033
13	115.041	24.766
14	118.988	27.835
15	122.667	31.220
16	126.055	34.898
17	129.127	38.843
18	131.862	43.029
19	134.241	47.426
20	136.249	52.005
21	137.872	56.735
22	138.445	59.000

Circle Center At X = 79.954 ; Y = 73.882 ; and Radius = 60.355

Factor of Safety  
\*\*\* 1.704 \*\*\*

Failure Surface Specified By 22 Coordinate Points

Point X-Surf Y-Surf

No.	(ft)	(ft)
1	63.158	17.803
2	67.988	16.509
3	72.901	15.582
4	77.870	15.028
5	82.867	14.848
6	87.863	15.044
7	92.830	15.616
8	97.740	16.560
9	102.566	17.869
10	107.279	19.538
11	111.853	21.557
12	116.263	23.914
13	120.483	26.596
14	124.489	29.587
15	128.260	32.871
16	131.772	36.430
17	135.007	40.242
18	137.947	44.287
19	140.573	48.541
20	142.873	52.981
21	144.832	57.581
22	145.314	59.000

Circle Center At X = 82.761 ; Y = 81.228 ; and Radius = 66.385

Factor of Safety  
\*\*\* 1.707 \*\*\*

Failure Surface Specified By 22 Coordinate Points

Point X-Surf Y-Surf

No.	(ft)	(ft)
1	63.158	17.803
2	67.967	16.436
3	72.869	15.450
4	77.833	14.853
5	82.829	14.647
6	87.826	14.834

7	92.792	15.413
8	97.698	16.380
9	102.512	17.729
10	107.206	19.452
11	111.750	21.538
12	116.116	23.974
13	120.278	26.746
14	124.209	29.836
15	127.885	33.225
16	131.284	36.892
17	134.384	40.815
18	137.167	44.969
19	139.615	49.329
20	141.713	53.867
21	143.448	58.557
22	143.574	59.000

Circle Center At X = 82.951 ; Y = 78.250 ; and Radius = 63.605  
 Factor of Safety  
 \*\*\* 1.710 \*\*\*

Failure Surface Specified By 24 Coordinate Points

Point No.	X-Surf (ft)	Y-Surf (ft)
1	53.947	17.628
2	58.749	16.232
3	63.630	15.151
4	68.572	14.390
5	73.553	13.951
6	78.551	13.836
7	83.547	14.046
8	88.518	14.579
9	93.445	15.435
10	98.305	16.608
11	103.079	18.095
12	107.746	19.889
13	112.287	21.981
14	116.683	24.364
15	120.914	27.028
16	124.964	29.960
17	128.815	33.150
18	132.450	36.582
19	135.855	40.244
20	139.016	44.118
21	141.917	48.190
22	144.549	52.442
23	146.899	56.855
24	147.868	59.000

Circle Center At X = 77.823 ; Y = 90.719 ; and Radius = 76.892  
 Factor of Safety  
 \*\*\* 1.710 \*\*\*

Failure Surface Specified By 23 Coordinate Points

Point No.	X-Surf (ft)	Y-Surf (ft)
1	59.211	17.728
2	64.001	16.296
3	68.884	15.218
4	73.832	14.500
5	78.819	14.146
6	83.819	14.157
7	88.805	14.534
8	93.750	15.274
9	98.627	16.374
10	103.411	17.828
11	108.076	19.627
12	112.597	21.763
13	116.950	24.224
14	121.111	26.996
15	125.058	30.065
16	128.770	33.415
17	132.227	37.027
18	135.411	40.882

19	138.305	44.960
20	140.893	49.238
21	143.161	53.694
22	145.097	58.304
23	145.331	59.000

Circle Center At X = 81.164 ; Y = 82.443 ; and Radius = 68.338  
 Factor of Safety  
 \*\*\* 1.713 \*\*\*

Failure Surface Specified By 21 Coordinate Points

Point No.	X-Surf (ft)	Y-Surf (ft)
1	63.158	17.803
2	67.906	16.236
3	72.777	15.109
4	77.731	14.432
5	82.726	14.211
6	87.721	14.446
7	92.673	15.136
8	97.541	16.276
9	102.285	17.855
10	106.865	19.861
11	111.243	22.278
12	115.381	25.083
13	119.246	28.255
14	122.806	31.767
15	126.029	35.589
16	128.891	39.689
17	131.365	44.034
18	133.433	48.586
19	135.076	53.309
20	136.282	58.161
21	136.410	59.000

Circle Center At X = 82.653 ; Y = 68.904 ; and Radius = 54.694  
 Factor of Safety  
 \*\*\* 1.714 \*\*\*

Failure Surface Specified By 23 Coordinate Points

Point No.	X-Surf (ft)	Y-Surf (ft)
1	59.211	17.728
2	64.047	16.460
3	68.958	15.521
4	73.921	14.915
5	78.914	14.644
6	83.913	14.711
7	88.897	15.114
8	93.842	15.852
9	98.727	16.922
10	103.528	18.318
11	108.224	20.034
12	112.794	22.063
13	117.217	24.395
14	121.472	27.020
15	125.541	29.926
16	129.405	33.099
17	133.047	36.525
18	136.449	40.189
19	139.597	44.073
20	142.476	48.161
21	145.074	52.434
22	147.377	56.872
23	148.305	59.000

Circle Center At X = 80.427 ; Y = 88.804 ; and Radius = 74.175  
 Factor of Safety  
 \*\*\* 1.715 \*\*\*

\*\*\*\* END OF GSTABL7 OUTPUT \*\*\*\*

# 12091-01 / John S. Gibson / Sec. I-I' MSE Wall "E" / Seismic

z:\2012\12091-01 howard industrial partners - john s gibbon blvd\engineering\slope stability\sections\i-i'\ixse.pl2 Run By: LGC Geotechnical 3/14/2019 08:17AM

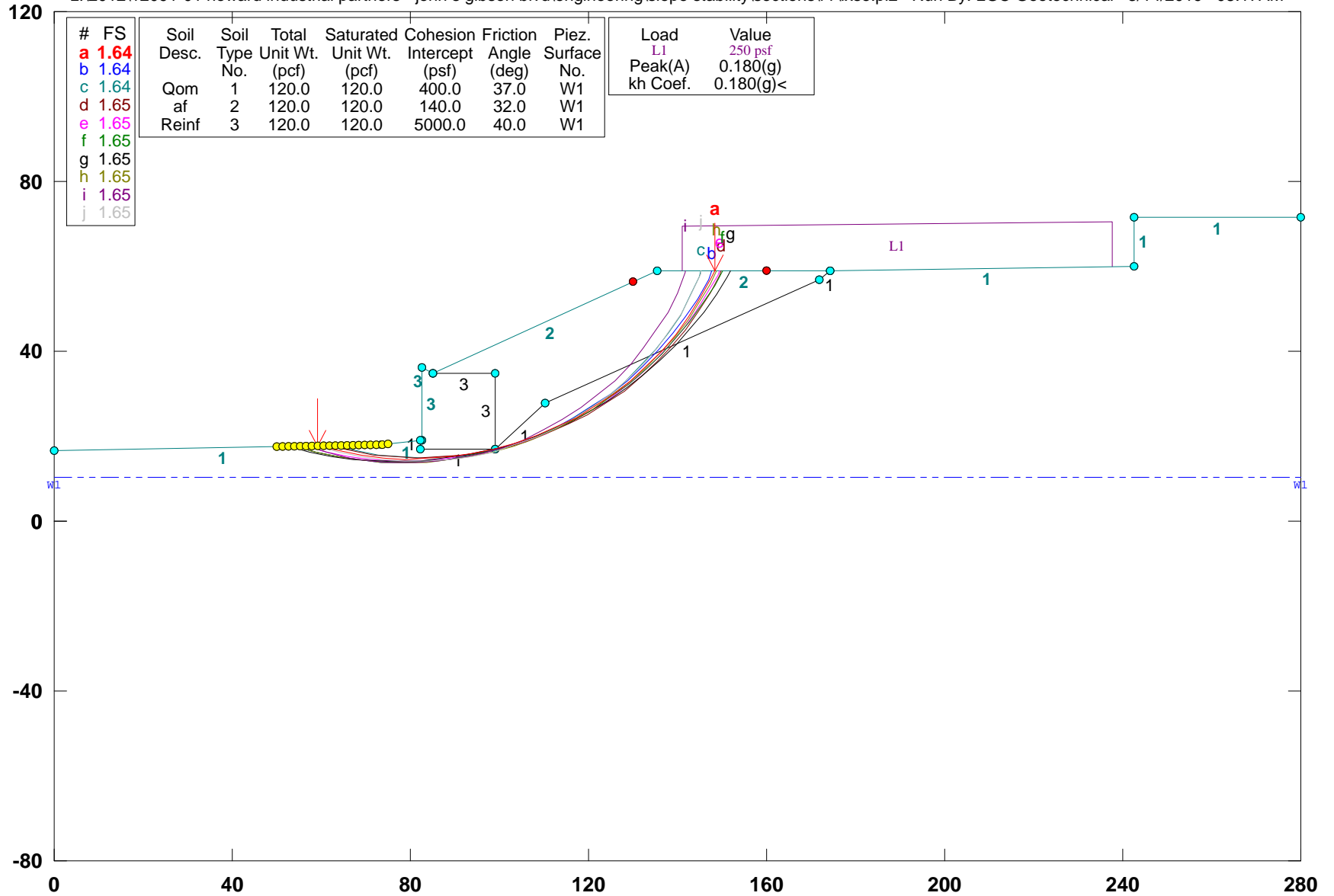

#	FS	Soil Desc.	Soil Type No.	Total Unit Wt. (pcf)	Saturated Unit Wt. (pcf)	Cohesion Intercept (psf)	Friction Angle (deg)	Piez. Surface No.
a	1.64		1	120.0	120.0	400.0	37.0	W1
b	1.64		2	120.0	120.0	140.0	32.0	W1
c	1.64		3	120.0	120.0	5000.0	40.0	W1
d	1.65							
e	1.65							
f	1.65							
g	1.65							
h	1.65							
i	1.65							
j	1.65							

Load	Value
L1	250 psf
Peak(A)	0.180(g)
kh Coef.	0.180(g)<

GSTABL7 v.2 FSmin=1.64  
 Safety Factors Are Calculated By The Modified Bishop Method

\*\*\* GSTABL7 \*\*\*

\*\* GSTABL7 by Dr. Garry H. Gregory, Ph.D., P.E., D.GE \*\*

\*\* Original Version 1.0, January 1996; Current Ver. 2.005.3, Feb. 2013 \*\*  
(All Rights Reserved-Unauthorised Use Prohibited)

\*\*\*\*\*

SLOPE STABILITY ANALYSIS SYSTEM

Modified Bishop, Simplified Janbu, or GLE Method of Slices.  
(Includes Spencer & Morgenstern-Price Type Analysis)  
Including Pier/Pile, Reinforcement, Soil Nail, Tieback,  
Nonlinear Undrained Shear Strength, Curved Phi Envelope,  
Anisotropic Soil, Fiber-Reinforced Soil, Boundary Loads, Water  
Surfaces, Pseudo-Static & Newmark Earthquake, and Applied Forces.

\*\*\*\*\*

Analysis Run Date: 3/14/2019  
Time of Run: 08:17AM  
Run By: LGC Geotechnical  
Input Data Filename: Z:\2012\12091-01 Howard Industrial Partners - John S Gibson  
Blvd\Engineering\Slope Stability\Sections\I-I'\ixse.in  
Output Filename: Z:\2012\12091-01 Howard Industrial Partners - John S Gibson  
Blvd\Engineering\Slope Stability\Sections\I-I'\ixse.OUT  
Unit System: English  
Plotted Output Filename: Z:\2012\12091-01 Howard Industrial Partners - John S Gibson  
Blvd\Engineering\Slope Stability\Sections\I-I'\ixse.PLT  
PROBLEM DESCRIPTION: 12091-01 / John S. Gibson / Sec. I-I'  
MSE Wall "E" / Seismic

BOUNDARY COORDINATES

9 Top Boundaries					
16 Total Boundaries					
Boundary No.	X-Left (ft)	Y-Left (ft)	X-Right (ft)	Y-Right (ft)	Soil Type Below Bnd
1	0.00	16.60	73.50	18.00	1
2	73.50	18.00	82.50	19.00	1
3	82.50	19.00	82.51	36.10	3
4	82.51	36.10	85.20	34.90	3
5	85.20	34.90	135.40	59.00	2
6	135.40	59.00	174.30	59.00	2
7	174.30	59.00	242.50	60.00	1
8	242.50	60.00	242.51	71.40	1
9	242.51	71.40	280.00	71.40	1
10	85.20	34.90	99.10	34.90	3
11	99.10	34.90	99.11	17.00	3
12	99.11	17.00	110.10	27.90	1
13	110.10	27.90	171.90	57.00	1
14	171.90	57.00	174.30	59.00	1
15	82.10	19.00	82.11	17.00	1
16	82.11	17.00	99.11	17.00	1

Default Y-Origin = 0.00(ft)  
Default X-Plus Value = 0.00(ft)  
Default Y-Plus Value = 0.00(ft)

ISOTROPIC SOIL PARAMETERS

3 Type(s) of Soil						
Soil Type No.	Total Unit Wt. (pcf)	Saturated Unit Wt. (pcf)	Cohesion (psf)	Friction Angle (deg)	Pore Pressure Param. (psf)	Piez. Constant (psf)
1	120.0	120.0	400.0	37.0	0.00	0.0
2	120.0	120.0	140.0	32.0	0.00	0.0
3	120.0	120.0	5000.0	40.0	0.00	0.0

1 PIEZOMETRIC SURFACE(S) SPECIFIED

Unit Weight of Water = 62.40 (pcf)  
Piezometric Surface No. 1 Specified by 2 Coordinate Points  
Pore Pressure Inclination Factor = 0.50

Point No.	X-Water (ft)	Y-Water (ft)
1	0.00	10.20
2	280.00	10.20

BOUNDARY LOAD(S)

1 Load(s) Specified				
Load No.	X-Left (ft)	X-Right (ft)	Intensity (psf)	Deflection (deg)
1	140.90	237.50	250.0	0.0

NOTE - Intensity Is Specified As A Uniformly Distributed

Force Acting On A Horizontally Projected Surface.  
Specified Peak Ground Acceleration Coefficient (A) = 0.180(g)  
Specified Horizontal Earthquake Coefficient (kh) = 0.180(g)  
Specified Vertical Earthquake Coefficient (kv) = 0.000(g)  
Specified Seismic Pore-Pressure Factor = 0.000

A Critical Failure Surface Searching Method, Using A Random  
Technique For Generating Circular Surfaces, Has Been Specified.  
5000 Trial Surfaces Have Been Generated.

250 Surface(s) Initiate(s) From Each Of 20 Points Equally Spaced

Along The Ground Surface Between X = 50.00(ft)

and X = 75.00(ft)

Each Surface Terminates Between X = 130.00(ft)

and X = 160.00(ft)

Unless Further Limitations Were Imposed, The Minimum Elevation

At Which A Surface Extends Is Y = 0.00(ft)

5.00(ft) Line Segments Define Each Trial Failure Surface.

Following Are Displayed The Ten Most Critical Of The Trial

Failure Surfaces Evaluated. They Are

Ordered - Most Critical First.

\* \* Safety Factors Are Calculated By The Modified Bishop Method \* \*

Total Number of Trial Surfaces Attempted = 5000

Number of Trial Surfaces With Valid FS = 5000

Statistical Data On All Valid FS Values:

FS Max = 2.979 FS Min = 1.641 FS Ave = 2.078

Standard Deviation = 0.226 Coefficient of Variation = 10.86 %

Failure Surface Specified By 23 Coordinate Points

Point No.	X-Surf (ft)	Y-Surf (ft)
1	59.211	17.728
2	64.047	16.460
3	68.958	15.521
4	73.921	14.915
5	78.914	14.644
6	83.913	14.711
7	88.897	15.114
8	93.842	15.852
9	98.727	16.922
10	103.528	18.318
11	108.224	20.034
12	112.794	22.063
13	117.217	24.395
14	121.472	27.020
15	125.541	29.926
16	129.405	33.099
17	133.047	36.525
18	136.449	40.189
19	139.597	44.073
20	142.476	48.161
21	145.074	52.434
22	147.377	56.872
23	149.305	59.000

Circle Center At X = 80.427 ; Y = 88.804 ; and Radius = 74.175

Factor of Safety

\*\*\* 1.641 \*\*\*

Individual data on the 36 slices

Slice No.	Width (ft)	Weight (lbs)	Water Force (lbs)		Tie Force (lbs)	Earthquake Force (lbs)		Surcharge Load (lbs)
			Top	Bot		Hor	Ver	
1	4.8	394.7	0.0	0.0	0.0	0.0	71.0	0.0
2	4.9	1105.8	0.0	0.0	0.0	0.0	199.0	0.0
3	4.5	1478.8	0.0	0.0	0.0	0.0	266.2	0.0
4	0.4	155.8	0.0	0.0	0.0	0.0	28.1	0.0
5	5.0	2123.7	0.0	0.0	0.0	0.0	382.3	0.0
6	3.2	1572.6	0.0	0.0	0.0	0.0	283.1	0.0
7	0.0	5.1	0.0	0.0	0.0	0.0	0.9	0.0
8	0.4	200.7	0.0	0.0	0.0	0.0	36.1	0.0
9	0.0	15.4	0.0	0.0	0.0	0.0	2.8	0.0
10	1.4	3551.1	0.0	0.0	0.0	0.0	639.2	0.0

11	1.3	3153.2	0.0	0.0	0.0	0.0	567.6	0.0	0.0
12	3.7	9238.4	0.0	0.0	0.0	0.0	1662.9	0.0	0.0
13	4.9	13280.3	0.0	0.0	0.0	0.0	2390.5	0.0	0.0
14	4.9	13969.8	0.0	0.0	0.0	0.0	2514.6	0.0	0.0
15	0.3	793.4	0.0	0.0	0.0	0.0	142.8	0.0	0.0
16	0.1	304.5	0.0	0.0	0.0	0.0	54.8	0.0	0.0
17	0.0	29.4	0.0	0.0	0.0	0.0	5.3	0.0	0.0
18	0.0	138.7	0.0	0.0	0.0	0.0	25.0	0.0	0.0
19	4.4	13095.2	0.0	0.0	0.0	0.0	2357.1	0.0	0.0
20	4.7	14454.9	0.0	0.0	0.0	0.0	2601.9	0.0	0.0
21	1.9	5842.7	0.0	0.0	0.0	0.0	1051.7	0.0	0.0
22	2.7	8416.2	0.0	0.0	0.0	0.0	1514.9	0.0	0.0
23	4.4	13788.4	0.0	0.0	0.0	0.0	2481.9	0.0	0.0
24	4.3	13065.3	0.0	0.0	0.0	0.0	2351.8	0.0	0.0
25	4.1	12118.2	0.0	0.0	0.0	0.0	2181.3	0.0	0.0
26	3.9	10981.4	0.0	0.0	0.0	0.0	1976.7	0.0	0.0
27	3.6	9694.4	0.0	0.0	0.0	0.0	1745.0	0.0	0.0
28	2.4	5828.9	0.0	0.0	0.0	0.0	1049.2	0.0	0.0
29	1.0	2440.2	0.0	0.0	0.0	0.0	439.2	0.0	0.0
30	0.2	349.1	0.0	0.0	0.0	0.0	62.8	0.0	0.0
31	3.0	6023.2	0.0	0.0	0.0	0.0	1084.2	0.0	0.0
32	1.3	2188.7	0.0	0.0	0.0	0.0	394.0	0.0	0.0
33	1.6	2262.1	0.0	0.0	0.0	0.0	407.2	0.0	394.1
34	2.6	2712.2	0.0	0.0	0.0	0.0	488.2	0.0	649.3
35	2.3	1201.6	0.0	0.0	0.0	0.0	216.3	0.0	575.8
36	0.9	118.6	0.0	0.0	0.0	0.0	21.3	0.0	232.1

Failure Surface Specified By 24 Coordinate Points

Point No.	X-Surf (ft)	Y-Surf (ft)
1	53.947	17.628
2	58.749	16.232
3	63.630	15.151
4	68.572	14.390
5	73.553	13.951
6	78.551	13.836
7	83.547	14.046
8	88.518	14.579
9	93.445	15.435
10	98.305	16.608
11	103.079	18.095
12	107.746	19.889
13	112.287	21.981
14	116.683	24.364
15	120.914	27.028
16	124.964	29.960
17	128.815	33.150
18	132.450	36.582
19	135.855	40.244
20	139.016	44.118
21	141.917	48.190
22	144.549	52.442
23	146.899	56.855
24	147.868	59.000

Circle Center At X = 77.823 ; Y = 90.719 ; and Radius = 76.892  
 Factor of Safety \*\*\* 1.642 \*\*\*

Failure Surface Specified By 22 Coordinate Points

Point No.	X-Surf (ft)	Y-Surf (ft)
1	63.158	17.803
2	67.988	16.509
3	72.901	15.582
4	77.870	15.028
5	82.867	14.848
6	87.863	15.044
7	92.830	15.616
8	97.740	16.560
9	102.566	17.869
10	107.279	19.538
11	111.853	21.557

12	116.263	23.914
13	120.483	26.596
14	124.489	29.587
15	128.260	32.871
16	131.772	36.430
17	135.007	40.242
18	137.947	44.287
19	140.573	48.541
20	142.873	52.981
21	144.832	57.581
22	145.314	59.000

Circle Center At X = 82.761 ; Y = 81.228 ; and Radius = 66.385  
 Factor of Safety \*\*\* 1.644 \*\*\*

Failure Surface Specified By 23 Coordinate Points

Point No.	X-Surf (ft)	Y-Surf (ft)
1	61.842	17.778
2	66.691	16.559
3	71.612	15.671
4	76.581	15.119
5	81.577	14.903
6	86.575	15.026
7	91.554	15.487
8	96.490	16.283
9	101.361	17.411
10	106.144	18.867
11	110.819	20.642
12	115.362	22.730
13	119.753	25.120
14	123.973	27.802
15	128.002	30.763
16	131.822	33.990
17	135.414	37.468
18	138.763	41.181
19	141.853	45.112
20	144.670	49.243
21	147.201	53.555
22	149.434	58.028
23	149.840	59.000

Circle Center At X = 82.262 ; Y = 88.775 ; and Radius = 73.875  
 Factor of Safety \*\*\* 1.645 \*\*\*

Failure Surface Specified By 24 Coordinate Points

Point No.	X-Surf (ft)	Y-Surf (ft)
1	56.579	17.678
2	61.397	16.341
3	66.292	15.321
4	71.243	14.621
5	76.228	14.243
6	81.228	14.191
7	86.221	14.463
8	91.185	15.059
9	96.100	15.976
10	100.945	17.211
11	105.700	18.757
12	110.344	20.610
13	114.858	22.760
14	119.223	25.199
15	123.421	27.916
16	127.433	30.900
17	131.242	34.138
18	134.833	37.617
19	138.191	41.322
20	141.301	45.237
21	144.150	49.346
22	146.726	53.631
23	149.018	58.075
24	149.422	59.000



Circle Center At X = 79.540 ; Y = 91.049 ; and Radius = 76.880

Factor of Safety

\*\*\* 1.645 \*\*\*

Failure Surface Specified By 24 Coordinate Points

Point No.	X-Surf (ft)	Y-Surf (ft)
1	53.947	17.628
2	58.762	16.279
3	63.651	15.233
4	68.597	14.494
5	73.578	14.064
6	78.577	13.946
7	83.573	14.139
8	88.547	14.643
9	93.481	15.457
10	98.354	16.576
11	103.148	17.996
12	107.844	19.713
13	112.424	21.718
14	116.870	24.006
15	121.165	26.565
16	125.293	29.388
17	129.236	32.462
18	132.980	35.776
19	136.510	39.317
20	139.813	43.070
21	142.876	47.023
22	145.686	51.158
23	148.233	55.461
24	150.041	59.000

Circle Center At X = 77.978 ; Y = 94.095 ; and Radius = 80.154

Factor of Safety

\*\*\* 1.646 \*\*\*

Failure Surface Specified By 25 Coordinate Points

Point No.	X-Surf (ft)	Y-Surf (ft)
1	52.632	17.603
2	57.464	16.317
3	62.363	15.317
4	67.312	14.606
5	72.294	14.187
6	77.293	14.059
7	82.290	14.225
8	87.269	14.684
9	92.212	15.433
10	97.103	16.471
11	101.925	17.794
12	106.661	19.397
13	111.295	21.275
14	115.811	23.421
15	120.194	25.828
16	124.428	28.488
17	128.498	31.391
18	132.392	34.528
19	136.095	37.887
20	139.595	41.458
21	142.880	45.228
22	145.938	49.184
23	148.759	53.312
24	151.333	57.598
25	152.067	59.000

Circle Center At X = 76.961 ; Y = 99.348 ; and Radius = 85.290

Factor of Safety

\*\*\* 1.650 \*\*\*

Failure Surface Specified By 24 Coordinate Points

Point No.	X-Surf (ft)	Y-Surf (ft)
1	53.947	17.628
2	58.744	16.217
3	63.622	15.117

4 68.560 14.333

5 73.538 13.868

6 78.536 13.723

7 83.533 13.900

8 88.508 14.398

9 93.441 15.214

10 98.311 16.345

11 103.099 17.787

12 107.784 19.534

13 112.347 21.578

14 116.770 23.911

15 121.033 26.523

16 125.120 29.403

17 129.013 32.540

18 132.697 35.921

19 136.156 39.531

20 139.376 43.357

21 142.344 47.381

22 145.047 51.587

23 147.474 55.959

24 148.915 59.000

Circle Center At X = 78.286 ; Y = 91.442 ; and Radius = 77.724

Factor of Safety

\*\*\* 1.650 \*\*\*

Failure Surface Specified By 23 Coordinate Points

Point No.	X-Surf (ft)	Y-Surf (ft)
1	56.579	17.678
2	61.344	16.162
3	66.209	15.010
4	71.147	14.228
5	76.131	13.820
6	81.131	13.790
7	86.119	14.137
8	91.066	14.859
9	95.945	15.952
10	100.728	17.410
11	105.387	19.224
12	109.896	21.385
13	114.229	23.880
14	118.362	26.694
15	122.271	29.812
16	125.933	33.216
17	129.329	36.887
18	132.437	40.803
19	135.242	44.942
20	137.726	49.281
21	139.876	53.795
22	141.680	58.459
23	141.844	59.000

Circle Center At X = 79.032 ; Y = 80.006 ; and Radius = 66.250

Factor of Safety

\*\*\* 1.651 \*\*\*

Failure Surface Specified By 23 Coordinate Points

Point No.	X-Surf (ft)	Y-Surf (ft)
1	59.211	17.728
2	64.001	16.296
3	68.884	15.218
4	73.832	14.500
5	78.819	14.146
6	83.819	14.157
7	88.805	14.534
8	93.750	15.274
9	98.627	16.374
10	103.411	17.828
11	108.076	19.627
12	112.597	21.763
13	116.950	24.224
14	121.111	26.996

15	125.058	30.065
16	128.770	33.415
17	132.227	37.027
18	135.411	40.882
19	138.305	44.960
20	140.893	49.238
21	143.161	53.694
22	145.097	58.304
23	145.331	59.000

Circle Center At X = 81.164 ; Y = 82.443 ; and Radius = 68.338  
Factor of Safety  
\*\*\* 1.653 \*\*\*  
\*\*\*\* END OF GSTABL7 OUTPUT \*\*\*\*

***Response to Comment No. 14***

SEISMIC LATERAL EARTH PRESSURES

$K_h = \frac{1}{2}$  of  $\frac{2}{3}$  of  $PGAm$        $PGAm = 0.69g$

$K_h = (\frac{1}{2})(\frac{2}{3})(0.69g) = \underline{0.23}$

Z=1 Sloping Backfill:

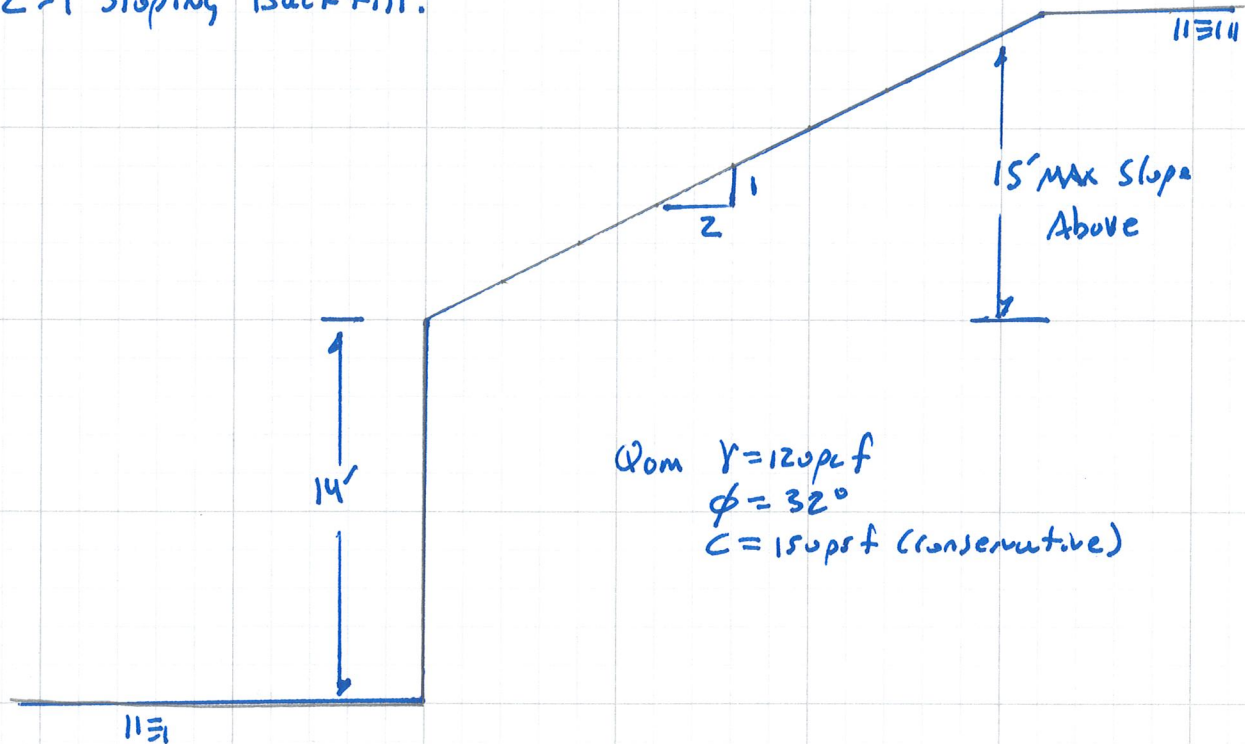

SEE ATTACHED CALCULATIONS FOR TOTAL SEISMIC PLUS STATIC PRESSURE OF 71.4 pcf

$71.4 pcf - 60 pcf = 11.4 pcf \therefore$  use 15 pcf seismic increment

Level Backfill:

Use minimum EFP value of 10 pcf (conservative)

Geometry		
Wall Vertical Height	14	feet
Backslope Angle $\beta$	26.6	degrees
Maximum Slope Height	29.0	feet
Slope Length	30.0	feet
Surcharge	0.0	psf

Results			
Wedge Failure Angle $\alpha$	37.5	degrees	
Earth Pressure Coefficient $k_{ae}$	0.595		
Maximum Earth Load $P_{ae}$	7000.6	lb/ft	
Equivalent Fluid Pressure EFP	71.4	pcf	

Soil Parameters		
Soil Unit Weight $\gamma$	120	pcf
Cohesion $c$	150	psf
Soil Friction Angle $\phi$	32	degrees
Wall Soil Friction Angle $\delta$	0	degrees
Crack Present	True	
Tension Crack Height	4.5	feet

Seismic Parameters	
Horizontal Coefficient $k_h$	0.23

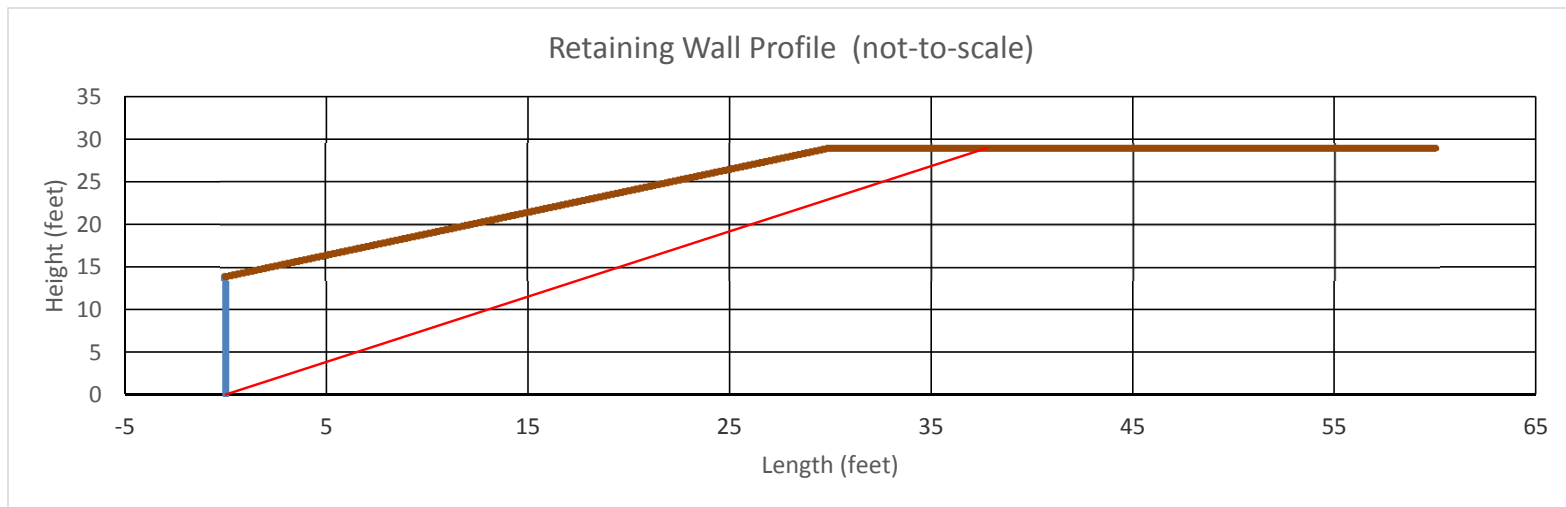

Spreadsheet Assumptions:  
 Vertical Wall (no batter), Neglect Wall Adhesion  
 When using wall friction, resultant load provided (conservative).



Wedge Analysis of Seismic Earth Pressure

Project Number: 12091-01

Date: 2/25/2019

San Pedro Distribution Center

*Appendix E*  
*General Earthwork and Grading*  
*Specifications for Rough Grading*

## **General Earthwork and Grading Specifications for Rough Grading**

### **1.0 General**

#### **1.1 Intent**

These General Earthwork and Grading Specifications are for the grading and earthwork shown on the approved grading plan(s) and/or indicated in the geotechnical report(s). These Specifications are a part of the recommendations contained in the geotechnical report(s). In case of conflict, the specific recommendations in the geotechnical report shall supersede these more general Specifications. Observations of the earthwork by the project Geotechnical Consultant during the course of grading may result in new or revised recommendations that could supersede these specifications or the recommendations in the geotechnical report(s).

#### **1.2 The Geotechnical Consultant of Record**

Prior to commencement of work, the owner shall employ a qualified Geotechnical Consultant of Record (Geotechnical Consultant). The Geotechnical Consultant shall be responsible for reviewing the approved geotechnical report(s) and accepting the adequacy of the preliminary geotechnical findings, conclusions, and recommendations prior to the commencement of the grading.

Prior to commencement of grading, the Geotechnical Consultant shall review the "work plan" prepared by the Earthwork Contractor (Contractor) and schedule sufficient personnel to perform the appropriate level of observation, mapping, and compaction testing.

During the grading and earthwork operations, the Geotechnical Consultant shall observe, map, and document the subsurface exposures to verify the geotechnical design assumptions. If the observed conditions are found to be significantly different than the interpreted assumptions during the design phase, the Geotechnical Consultant shall inform the owner, recommend appropriate changes in design to accommodate the observed conditions, and notify the review agency where required.

The Geotechnical Consultant shall observe the moisture-conditioning and processing of the subgrade and fill materials and perform relative compaction testing of fill to confirm that the attained level of compaction is being accomplished as specified. The Geotechnical Consultant shall provide the test results to the owner and the Contractor on a routine and frequent basis.

#### **1.3 The Earthwork Contractor**

The Earthwork Contractor (Contractor) shall be qualified, experienced, and knowledgeable in earthwork logistics, preparation and processing of ground to receive fill, moisture-conditioning and processing of fill, and compacting fill. The Contractor shall review and accept the plans, geotechnical report(s), and these Specifications prior to commencement of grading. The Contractor shall be solely responsible for performing the grading in accordance with the project plans and specifications. The Contractor shall prepare and submit to the owner and the Geotechnical Consultant a work plan that indicates the sequence of earthwork grading, the number of "equipment" of work and the estimated quantities of daily earthwork

contemplated for the site prior to commencement of grading. The Contractor shall inform the owner and the Geotechnical Consultant of changes in work schedules and updates to the work plan at least 24 hours in advance of such changes so that appropriate personnel will be available for observation and testing. The Contractor shall not assume that the Geotechnical Consultant is aware of all grading operations.

The Contractor shall have the sole responsibility to provide adequate equipment and methods to accomplish the earthwork in accordance with the applicable grading codes and agency ordinances, these Specifications, and the recommendations in the approved geotechnical report(s) and grading plan(s). If, in the opinion of the Geotechnical Consultant, unsatisfactory conditions, such as unsuitable soil, improper moisture condition, inadequate compaction, insufficient buttress key size, adverse weather, etc., are resulting in a quality of work less than required in these specifications, the Geotechnical Consultant shall reject the work and may recommend to the owner that construction be stopped until the conditions are rectified. It is the contractor's sole responsibility to provide proper fill compaction.

## **2.0 Preparation of Areas to be Filled**

### **2.1 Clearing and Grubbing**

Vegetation, such as brush, grass, roots, and other deleterious material shall be sufficiently removed and properly disposed of in a method acceptable to the owner, governing agencies, and the Geotechnical Consultant.

The Geotechnical Consultant shall evaluate the extent of these removals depending on specific site conditions. Earth fill material shall not contain more than 1 percent of organic materials (by volume). Nesting of the organic materials shall not be allowed.

If potentially hazardous materials are encountered, the Contractor shall stop work in the affected area, and a hazardous material specialist shall be informed immediately for proper evaluation and handling of these materials prior to continuing to work in that area.

As presently defined by the State of California, most refined petroleum products (gasoline, diesel fuel, motor oil, grease, coolant, etc.) have chemical constituents that are considered to be hazardous waste. As such, the indiscriminate dumping or spillage of these fluids onto the ground may constitute a misdemeanor, punishable by fines and/or imprisonment, and shall not be allowed. The contractor is responsible for all hazardous waste relating to his work. The Geotechnical Consultant does not have expertise in this area. If hazardous waste is a concern, then the Client should acquire the services of a qualified environmental assessor.

### **2.2 Processing**

Existing ground that has been declared satisfactory for support of fill by the Geotechnical Consultant shall be scarified to a minimum depth of 6 inches. Existing ground that is not satisfactory shall be over-excavated as specified in the following section. Scarification shall continue until soils are broken down and free of oversize material and the working surface is reasonably uniform, flat, and free of uneven features that would inhibit uniform compaction.



### **2.3 Over-excavation**

In addition to removals and over-excavations recommended in the approved geotechnical report(s) and the grading plan, soft, loose, dry, saturated, spongy, organic-rich, highly fractured or otherwise unsuitable ground shall be over-excavated to competent ground as evaluated by the Geotechnical Consultant during grading.

### **2.4 Benching**

Where fills are to be placed on ground with slopes steeper than 5:1 (horizontal to vertical units), the ground shall be stepped or benched. Please see the Standard Details for a graphic illustration. The lowest bench or key shall be a minimum of 15 feet wide and at least 2 feet deep, into competent material as evaluated by the Geotechnical Consultant. Other benches shall be excavated a minimum height of 4 feet into competent material or as otherwise recommended by the Geotechnical Consultant. Fill placed on ground sloping flatter than 5:1 shall also be benched or otherwise over-excavated to provide a flat subgrade for the fill.

### **2.5 Evaluation/Acceptance of Fill Areas**

All areas to receive fill, including removal and processed areas, key bottoms, and benches, shall be observed, mapped, elevations recorded, and/or tested prior to being accepted by the Geotechnical Consultant as suitable to receive fill. The Contractor shall obtain a written acceptance from the Geotechnical Consultant prior to fill placement. A licensed surveyor shall provide the survey control for determining elevations of processed areas, keys, and benches.

## **3.0 Fill Material**

### **3.1 General**

Material to be used as fill shall be essentially free of organic matter and other deleterious substances evaluated and accepted by the Geotechnical Consultant prior to placement. Soils of poor quality, such as those with unacceptable gradation, high expansion potential, or low strength shall be placed in areas acceptable to the Geotechnical Consultant or mixed with other soils to achieve satisfactory fill material.

### **3.2 Oversize**

Oversize material defined as rock, or other irreducible material with a maximum dimension greater than 8 inches, shall not be buried or placed in fill unless location, materials, and placement methods are specifically accepted by the Geotechnical Consultant. Placement operations shall be such that nesting of oversized material does not occur and such that oversize material is completely surrounded by compacted or densified fill. Oversize material shall not be placed within 10 vertical feet of finish grade or within 2 feet of future utilities or underground construction.

### **3.3 Import**

If importing of fill material is required for grading, proposed import material shall meet the requirements of the geotechnical consultant. The potential import source shall be given to the Geotechnical Consultant at least 48 hours (2 working days) before importing begins so that its suitability can be determined and appropriate tests performed.

## **4.0 Fill Placement and Compaction**

### **4.1 Fill Layers**

Approved fill material shall be placed in areas prepared to receive fill (per Section 3.0) in near-horizontal layers not exceeding 8 inches in loose thickness. The Geotechnical Consultant may accept thicker layers if testing indicates the grading procedures can adequately compact the thicker layers. Each layer shall be spread evenly and mixed thoroughly to attain relative uniformity of material and moisture throughout.

### **4.2 Fill Moisture Conditioning**

Fill soils shall be watered, dried back, blended, and/or mixed, as necessary to attain a relatively uniform moisture content at or slightly over optimum. Maximum density and optimum soil moisture content tests shall be performed in accordance with the American Society of Testing and Materials (ASTM Test Method D1557).

### **4.3 Compaction of Fill**

After each layer has been moisture-conditioned, mixed, and evenly spread, it shall be uniformly compacted to not less than 90 percent of maximum dry density (ASTM Test Method D1557). Compaction equipment shall be adequately sized and be either specifically designed for soil compaction or of proven reliability to efficiently achieve the specified level of compaction with uniformity.

### **4.4 Compaction of Fill Slopes**

In addition to normal compaction procedures specified above, compaction of slopes shall be accomplished by backrolling of slopes with sheepfoot rollers at increments of 3 to 4 feet in fill elevation, or by other methods producing satisfactory results acceptable to the Geotechnical Consultant. Upon completion of grading, relative compaction of the fill, out to the slope face, shall be at least 90 percent of maximum density per ASTM Test Method D1557.

### **4.5 Compaction Testing**

Field tests for moisture content and relative compaction of the fill soils shall be performed by the Geotechnical Consultant. Location and frequency of tests shall be at the Consultant's discretion based on field conditions encountered. Compaction test locations will not necessarily be selected on a random basis. Test locations shall be selected to verify adequacy of compaction levels in areas that are judged to be prone to inadequate compaction (such as close to slope faces and at the fill/bedrock benches).

#### **4.6 Frequency of Compaction Testing**

Tests shall be taken at intervals not exceeding 2 feet in vertical rise and/or 1,000 cubic yards of compacted fill soils embankment. In addition, as a guideline, at least one test shall be taken on slope faces for each 5,000 square feet of slope face and/or each 10 feet of vertical height of slope. The Contractor shall assure that fill construction is such that the testing schedule can be accomplished by the Geotechnical Consultant. The Contractor shall stop or slow down the earthwork construction if these minimum standards are not met.

#### **4.7 Compaction Test Locations**

The Geotechnical Consultant shall document the approximate elevation and horizontal coordinates of each test location. The Contractor shall coordinate with the project surveyor to assure that sufficient grade stakes are established so that the Geotechnical Consultant can determine the test locations with sufficient accuracy. At a minimum, two grade stakes within a horizontal distance of 100 feet and vertically less than 5 feet apart from potential test locations shall be provided.

#### **5.0 Subdrain Installation**

Subdrain systems shall be installed in accordance with the approved geotechnical report(s), the grading plan, and the Standard Details. The Geotechnical Consultant may recommend additional subdrains and/or changes in subdrain extent, location, grade, or material depending on conditions encountered during grading. All subdrains shall be surveyed by a land surveyor/civil engineer for line and grade after installation and prior to burial. Sufficient time should be allowed by the Contractor for these surveys.

#### **6.0 Excavation**

Excavations, as well as over-excavation for remedial purposes, shall be evaluated by the Geotechnical Consultant during grading. Remedial removal depths shown on geotechnical plans are estimates only. The actual extent of removal shall be determined by the Geotechnical Consultant based on the field evaluation of exposed conditions during grading. Where fill-over-cut slopes are to be graded, the cut portion of the slope shall be made, evaluated, and accepted by the Geotechnical Consultant prior to placement of materials for construction of the fill portion of the slope, unless otherwise recommended by the Geotechnical Consultant.

#### **7.0 Trench Backfills**

**7.1** The Contractor shall follow all OSHA and Cal/OSHA requirements for safety of trench excavations.

**7.2** All bedding and backfill of utility trenches shall be done in accordance with the applicable provisions of Standard Specifications of Public Works Construction. Bedding material shall have a Sand Equivalent greater than 30 (SE>30). The bedding shall be placed to 1 foot over

the top of the conduit and densified by jetting. Backfill shall be placed and densified to a minimum of 90 percent of maximum from 1 foot above the top of the conduit to the surface.

- 7.3 The jetting of the bedding around the conduits shall be observed by the Geotechnical Consultant.
- 7.4 The Geotechnical Consultant shall test the trench backfill for relative compaction. At least one test should be made for every 300 feet of trench and 2 feet of fill.
- 7.5 Lift thickness of trench backfill shall not exceed those allowed in the Standard Specifications of Public Works Construction unless the Contractor can demonstrate to the Geotechnical Consultant that the fill lift can be compacted to the minimum relative compaction by his alternative equipment and method.

### Fill Slope

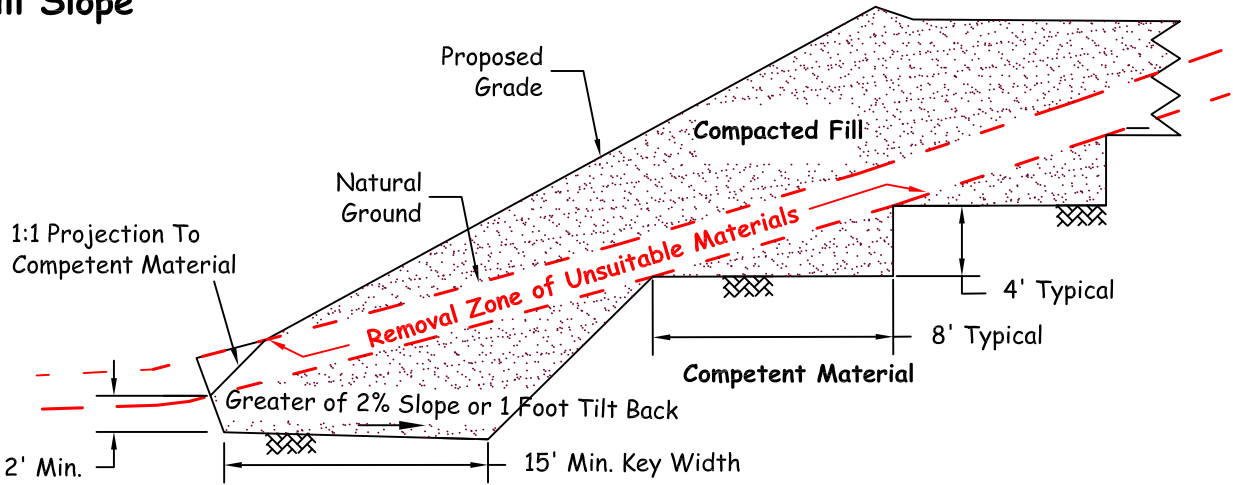

### Fill-Over-Cut Slope

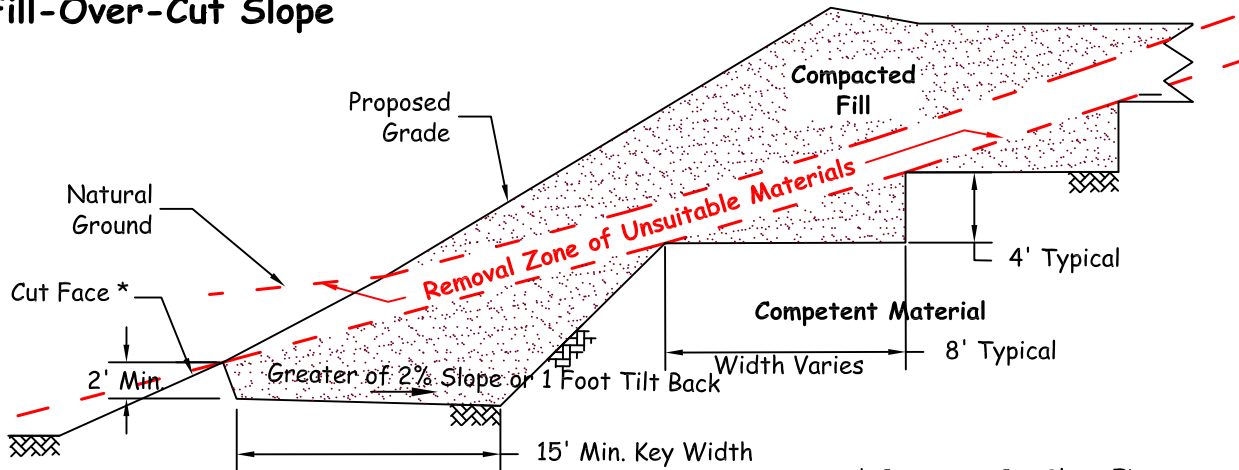

\* Construct Cut Slope First

### Cut-Over-Fill Slope

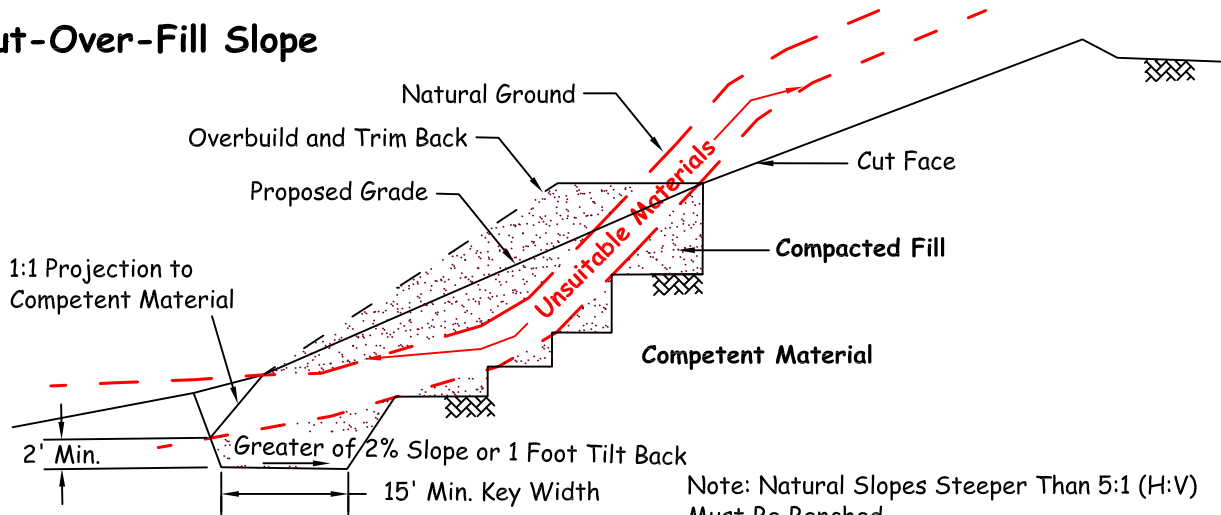

Note: Natural Slopes Steeper Than 5:1 (H:V) Must Be Benched.



## KEYING AND BENCHING

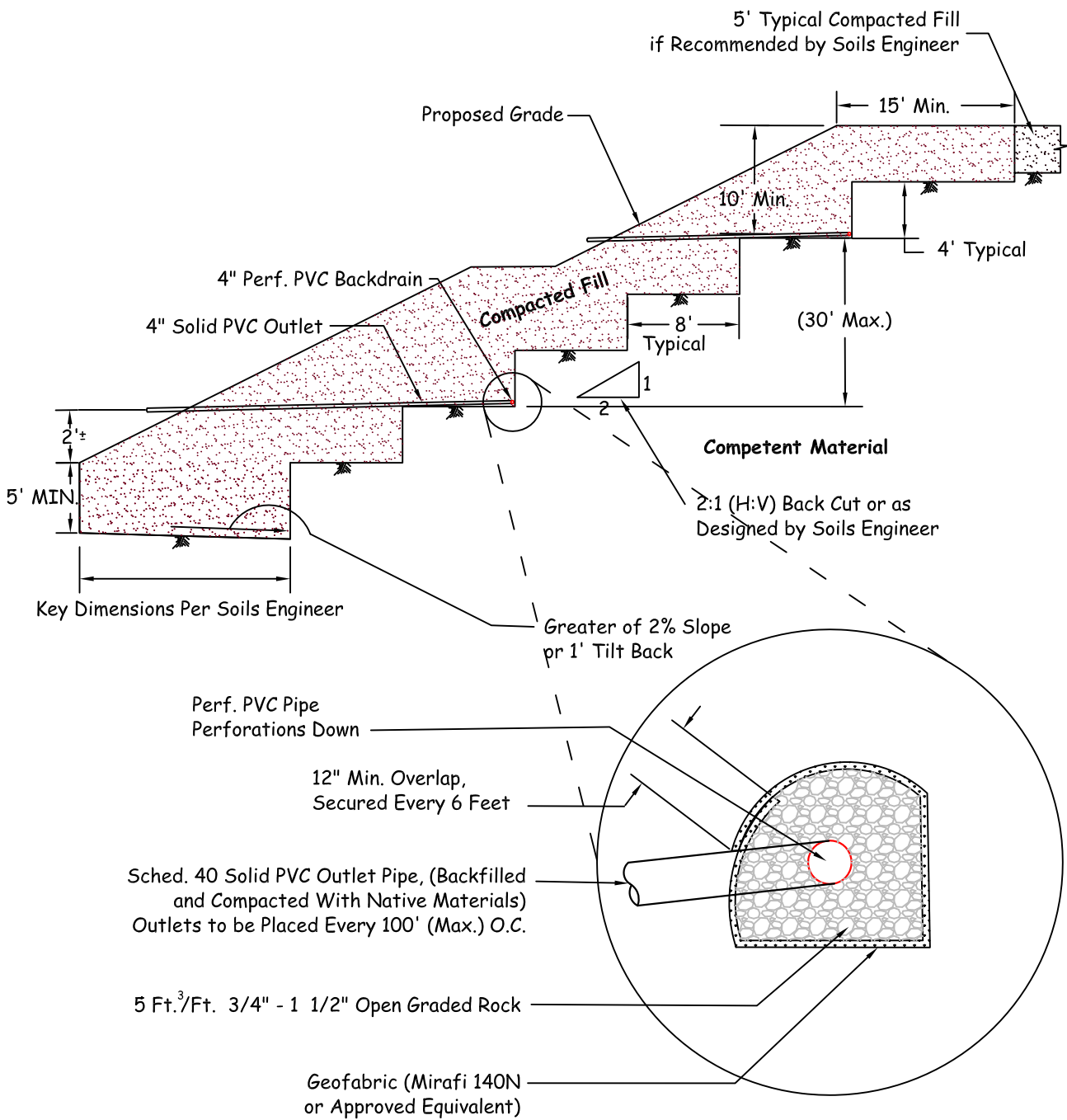

## TYPICAL BUTTRESS DETAIL

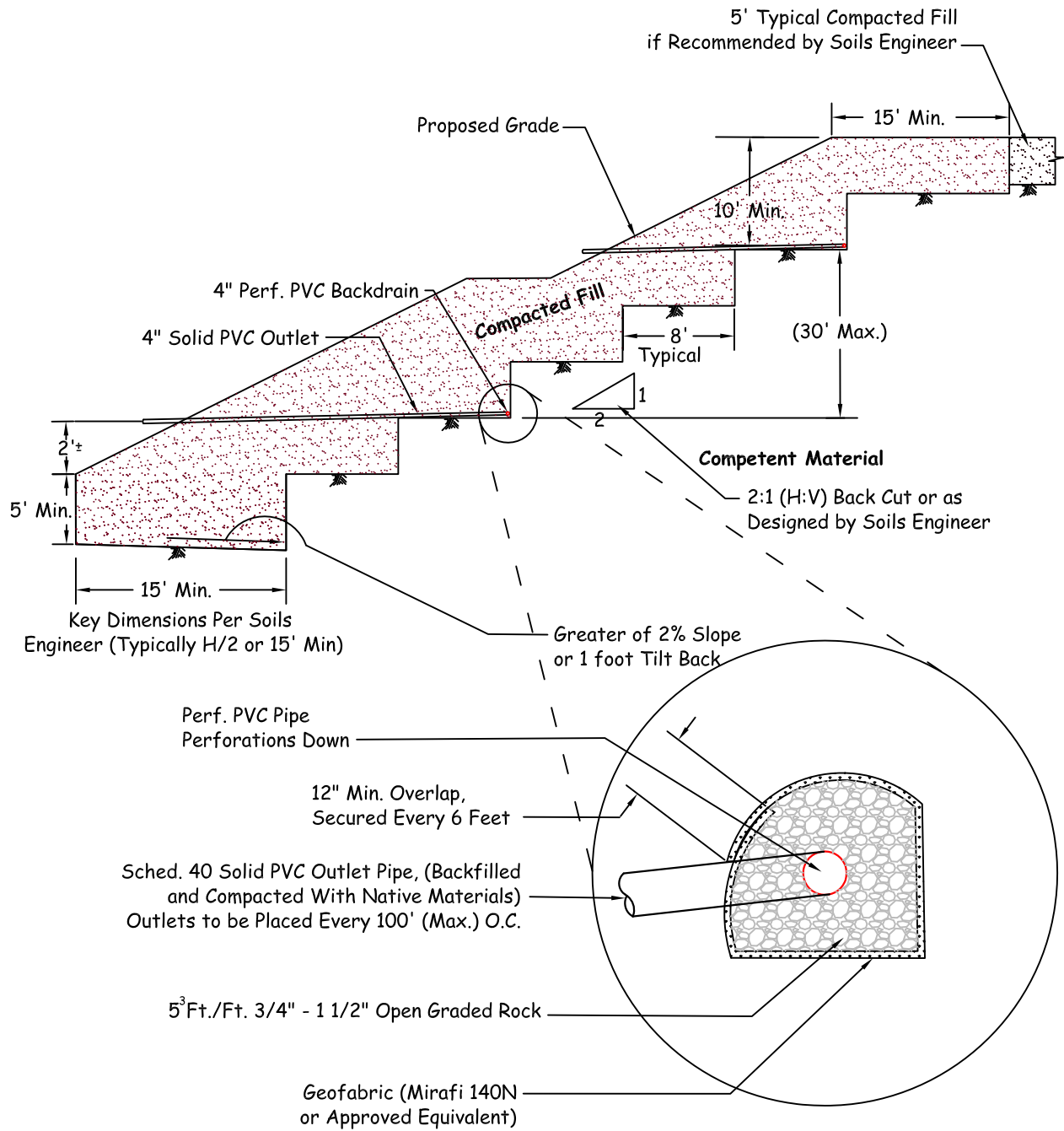

## TYPICAL STABILIZATION FILL DETAIL

# SUBDRAIN OUTLET MARKER -6" & 8" PIPE

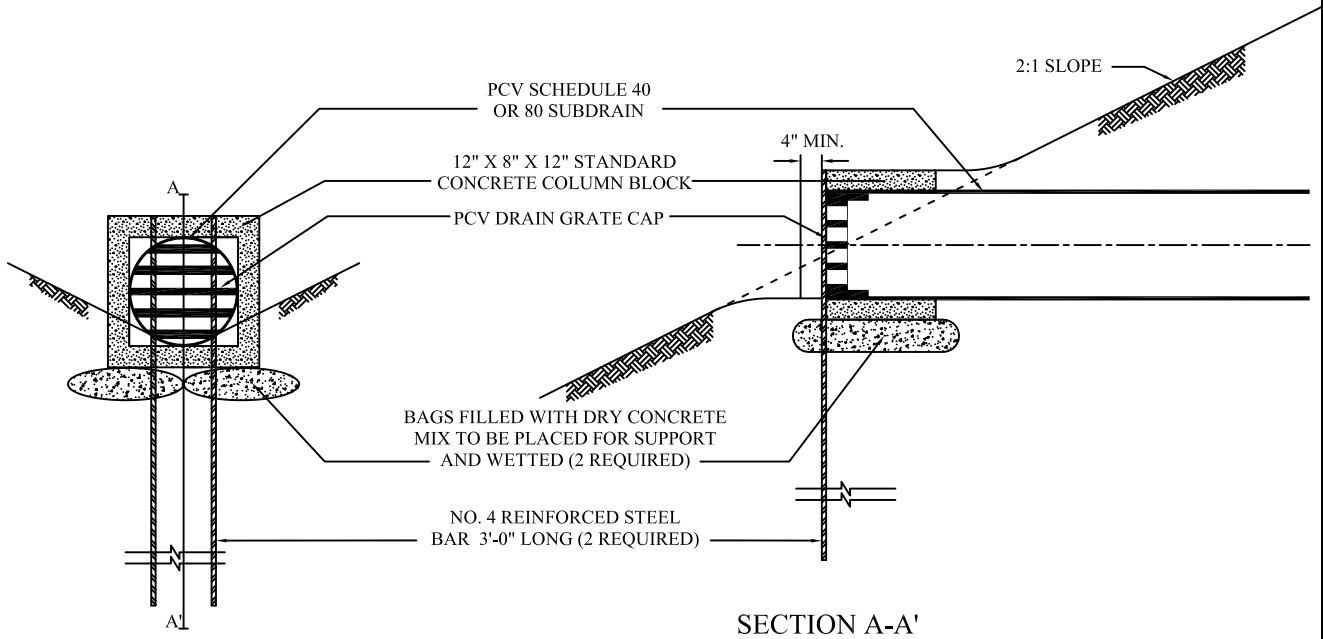

# SUBDRAIN OUTLET MARKER -4" PIPE

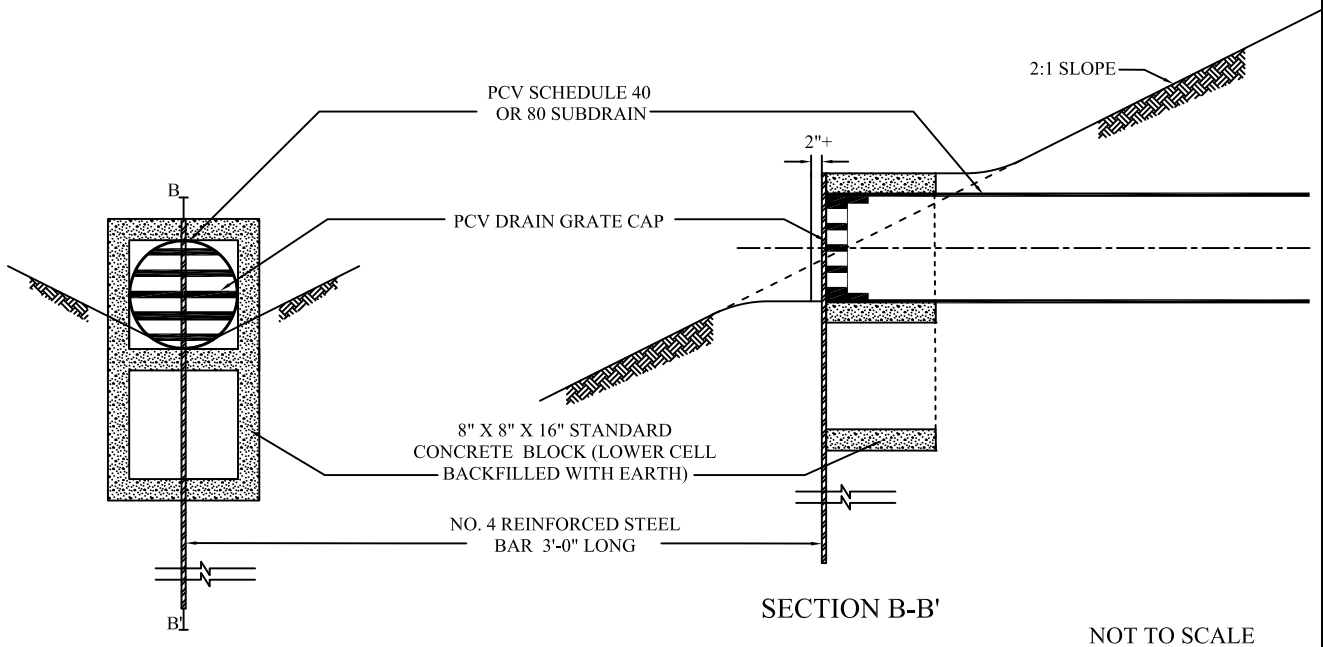

**SUBDRAIN OUTLET  
MARKER DETAIL**





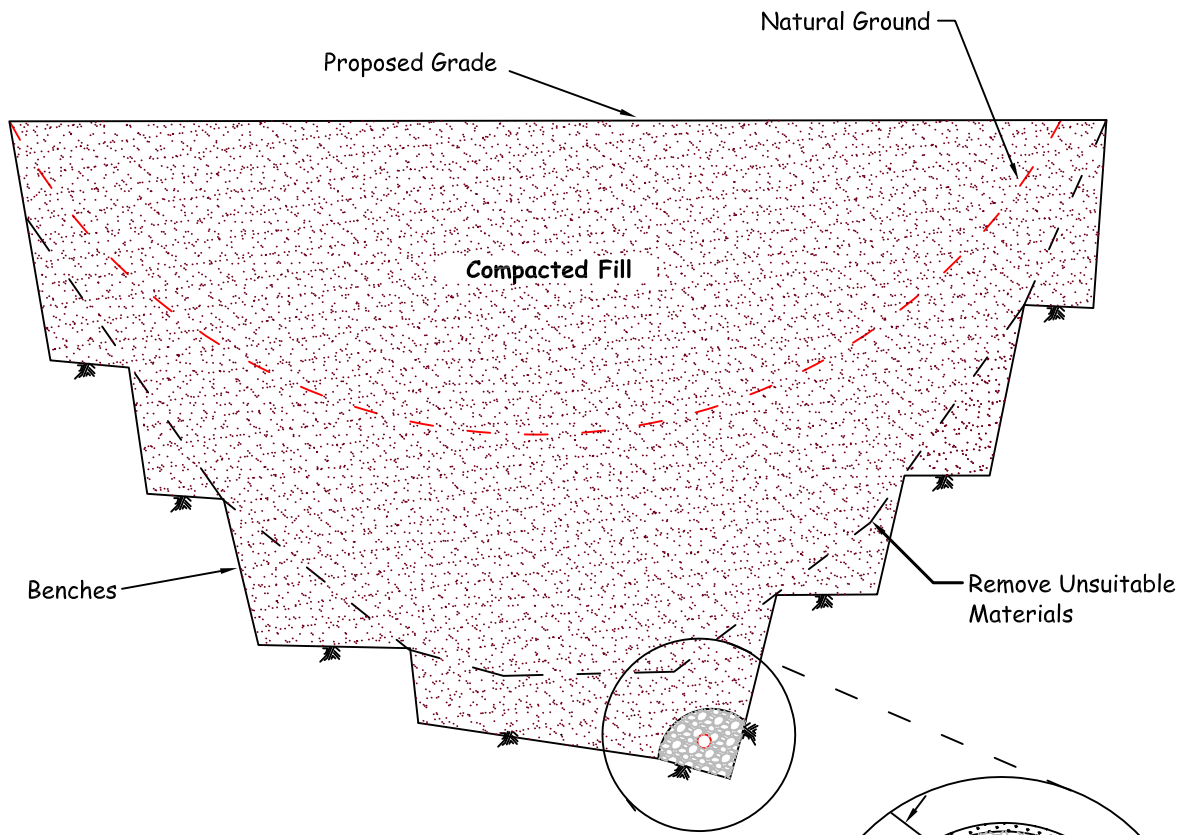

Notes:

- 1) Continuous Runs in Excess of 500' Shall Use 8" Diameter Pipe.
- 2) Final 20' of Pipe at Outlet Shall be Solid and Backfilled with Fine-grained Material.

12" Min. Overlap,  
Secured Every 6 Feet

6" Collector Pipe  
(Sched. 40, Perf. PVC)

9 Ft.<sup>3</sup>/Ft.  
3/4" - 1 1/2" Crushed Rock

Geofabric (Mirafi 140N  
or Approved Equivalent)

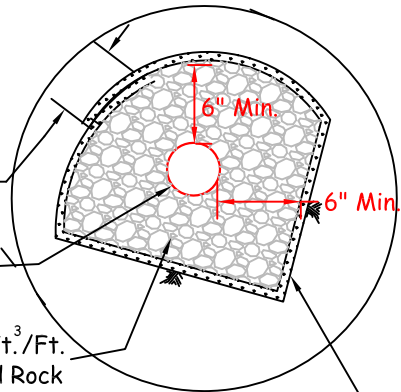

Proposed Outlet Detail

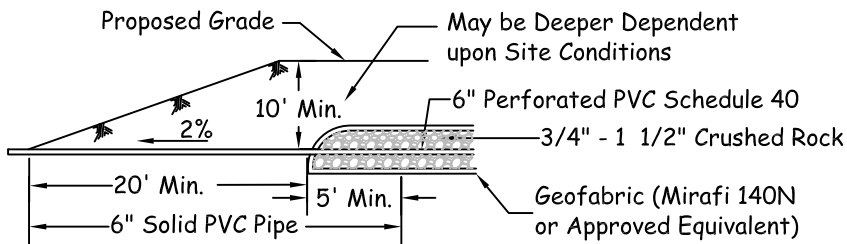

**CANYON SUBDRAINS**

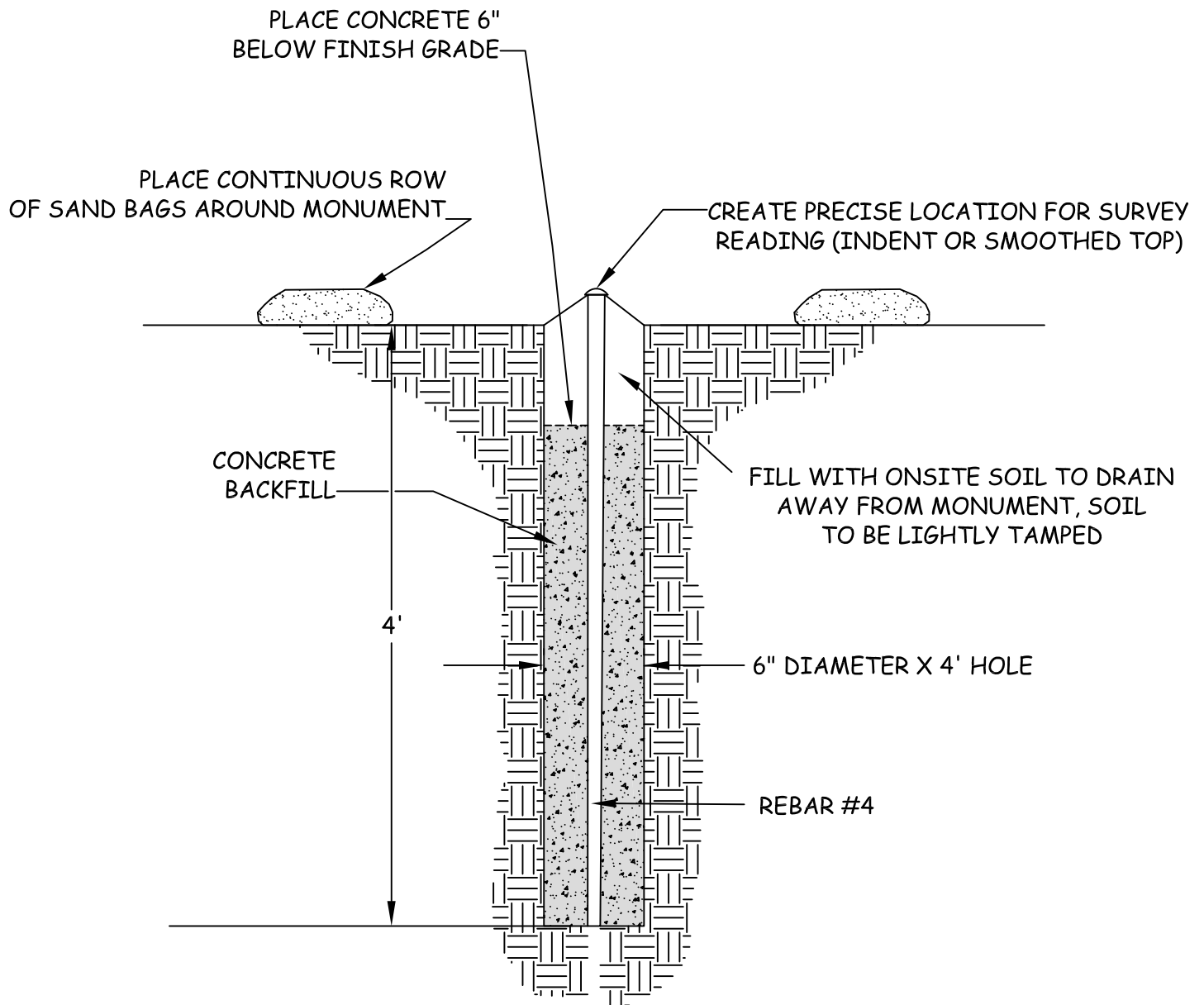

NO CONSTRUCTION EQUIPMENT WITHIN 25 FEET OF ANY INSTALLED SETTLEMENT MONUMENTS



## TYPICAL SURFACE SETTLEMENT MONUMENT

TOP VIEW

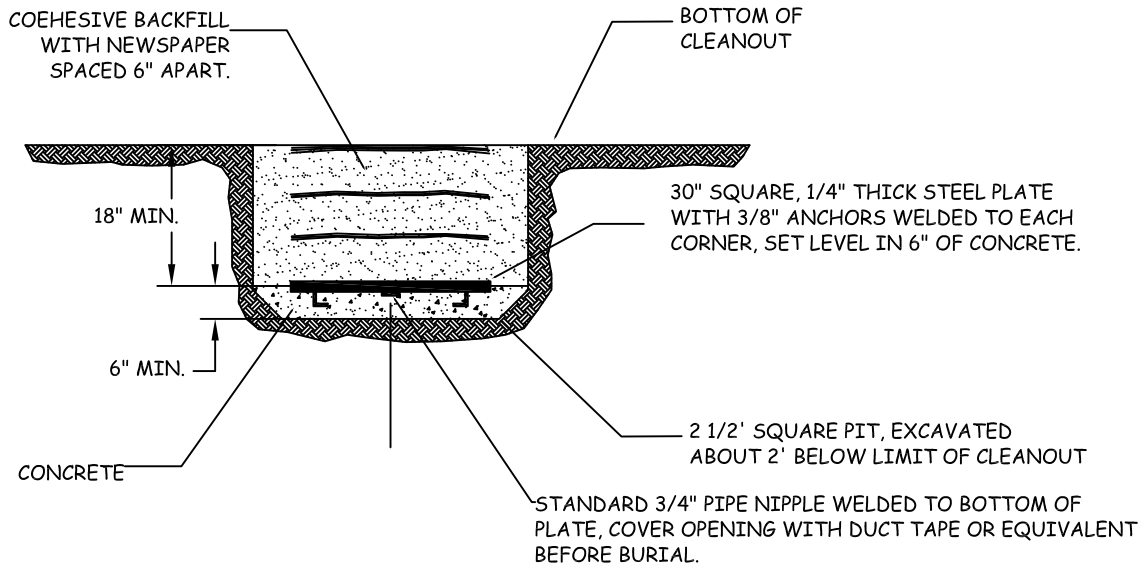
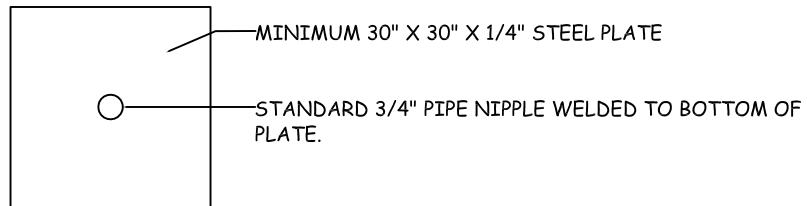

1. SURVEY FOR HORIZONTAL AND VERTICAL LOCATION TO NEAREST .01 INCH PRIOR TO BACKFILL USING KNOW LOCATIONS THAT WILL REMAIN INTACT DURING THE DURATION OF THE MONITORING PROGRAM. KNOW POINTS EXPLICITLY NOT ALLOWED ARE THOSE LOCATED ON FILL OR THAT WILL BE DESTROYED DURING GRADING.
2. IN THE EVENT OF DAMAGE TO SETTLEMENT PLATE DURING GRADING, CONTRACTOR SHALL IMMEDIATELY NOTIFY THE GEOTECHNICAL ENGINEER AND SHALL BE RESPONSIBLE FOR RESTORING THE SETTLEMENT PLATES TO WORKING ORDER.
3. DRILL TO RECOVER AND ATTACH RISER PIPE.



## TYPICAL SETTLEMENT PLATE AND RISER

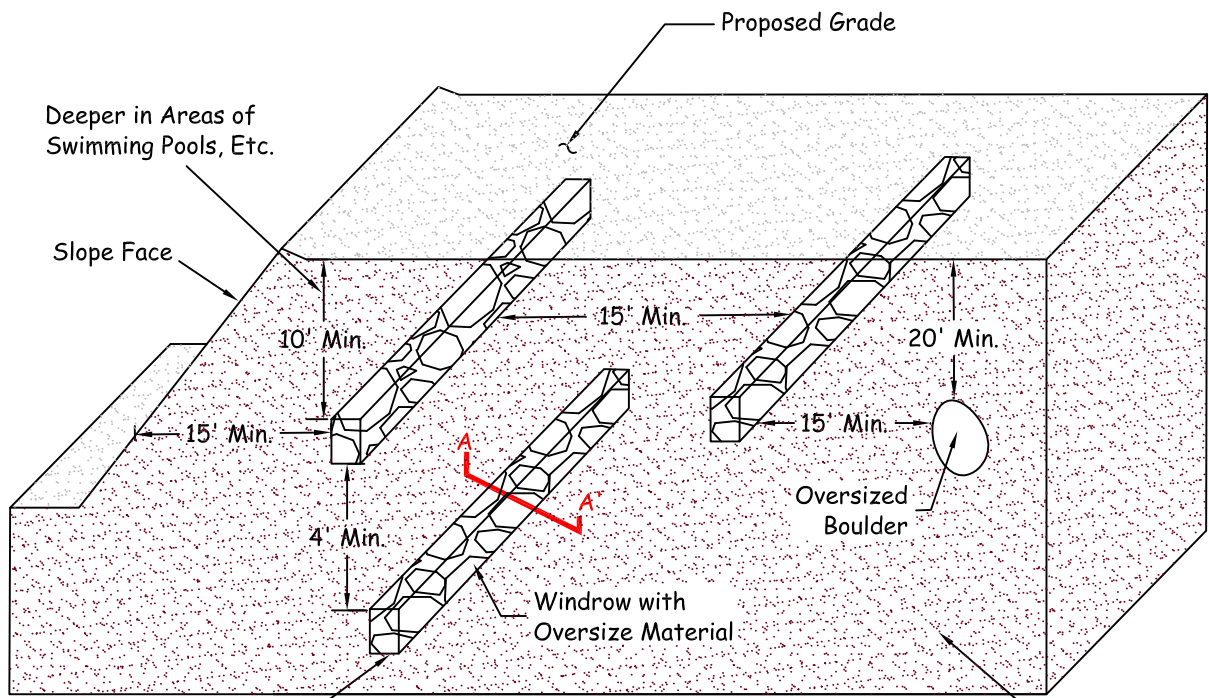

Windrow Parallel to Slope Face

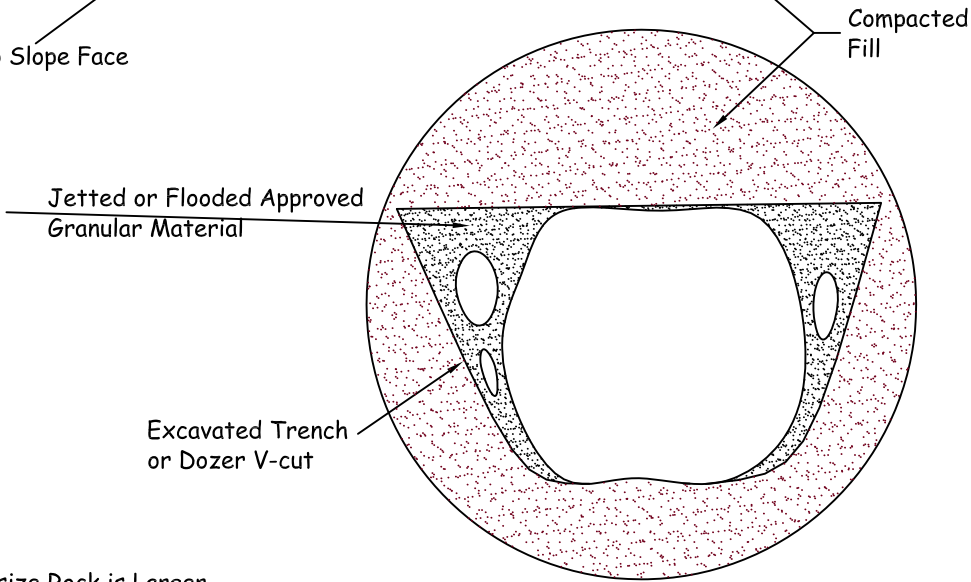

Note: Oversize Rock is Larger than 8" in Maximum Dimension.

**Section A-A'**



**OVERSIZE ROCK DISPOSAL DETAIL**

*Appendix F*  
*City of Los Angeles Review Sheet*  
*dated March 30, 2018*

# CITY OF LOS ANGELES

CALIFORNIA



BOARD OF  
BUILDING AND SAFETY  
COMMISSIONERS

VAN AMBATIELOS  
PRESIDENT

E. FELICIA BRANNON  
VICE PRESIDENT

JOSELYN GEAGA-ROSENTHAL  
GEORGE HOVAGUIMIAN  
JAVIER NUNEZ

ERIC GARCETTI  
MAYOR

DEPARTMENT OF  
BUILDING AND SAFETY  
201 NORTH FIGUEROA STREET  
LOS ANGELES, CA 90012

FRANK M. BUSH  
GENERAL MANAGER  
SUPERINTENDENT OF BUILDING

OSAMA YOUNAN, P.E.  
EXECUTIVE OFFICER

## GEOLOGY AND SOILS REPORT REVIEW LETTER

March 30, 2018

LOG # 102389  
SOILS/GEOLOGY FILE - 2  
PRFSA-San Pedro

Howard Industrial Partners  
1944 N. Tustin Street, Suite 122  
Tustin, CA 92865

TRACT: 3192  
LOT: PT 12 (Arb. 5)  
LOCATION: 1599 W. John S. Gibson Boulevard

<u>CURRENT REFERENCE</u> <u>REPORT/LETTER(S)</u>	<u>REPORT</u> <u>No.</u>	<u>DATE OF</u> <u>DOCUMENT</u>	<u>PREPARED BY</u>
Update Report	12091-01	03/09/2018	LGC Geotechnical, Inc.
Infiltration Report	1400	05/18/2017	Ron Barto
Response Report	041104-01	07/20/2007	Lawson & Associates
Supplemental Report	``	07/19/2007	``
Geology/Soils Report	``	01/27/2005	``

The Grading Division of the Department of Building and Safety has reviewed the referenced reports that provide recommendations for the proposed San Pedro Distribution Center. A current project description and map were not provided for review.

The project is located within a Preliminary Fault Rupture Study Area (PFRSA) identified by the City of Los Angeles. The site according to the consultants is also located in a designated seismically induced landslide hazard zone as shown on the Seismic Hazard Zones map issued by the State of California.

The review of the subject reports cannot be completed at this time and will be continued upon submittal of an addendum to the report which shall include, but not be limited to, the following:

(Note: Numbers in parenthesis ( ) refer to applicable sections of the 2017 City of LA Building Code. P/BC numbers refer the applicable Information Bulletin. Information Bulletins can be accessed on the internet at LADBS.ORG.)

1. Provide a complete and clear description of the proposed construction.

2. It appears that the site is located on a City of Los Angeles Preliminary Fault Study Area. A fault investigation shall be conducted in accordance with guidelines presented in P/BC 2017-129.
3. The current consultants state in their update letter that additional geotechnical evaluation and analysis should be performed to address the new areas of the site. Provide a complete stand-alone geology/soils report for the proposed construction. Note: The previous reports over 10 years old are not per current 2017 Los Angeles Building Code and according to the consultants the previous company is no longer in business. Also, incorporate the findings of the recent 05/18/2017 report into the requested report, as appropriate.
4. Identify all non-conforming conditions and provide recommendations to bring the entire site into conformance with the current Code standard (7005.9). Provide recommendations to remove and/or stabilize all landslide debris onsite.

Note: Current Code standard shall include but not be limited to removal and/or support of all existing non-conforming graded slopes and, underpinning/replacement of all existing foundations where not in conformance with current Code standards. Please be aware that all existing graded slopes steeper than 2H:1V will be considered as non-conforming.

5. Where the consultants will be relying on data from previous consultants, the consultants shall provide a statement that referenced previous reports were reviewed, that they either concur with or do not concur with the findings contained therein, and that they will accept professional responsibility for the use of any data from others.
6. No map was provided with the current update report reflecting the proposed site conditions. Provide recommendations and revise the plan(s) and cross section(s) for providing the required building setback from the toe of the ascending slope as specified by Code Section 1808.7.1
7. Provide a geologic map and cross sections that are based upon conceptual grading or site development plans, to illustrate all proposed and existing contours relative to the planned grading and/or construction, along with all off-site slopes and conditions that could adversely affect the stability or safety of the site (7006.3.2). The geologic map and cross sections shall depict the top and bottom of slopes; lithologic contacts; bedding attitudes; locations of slumps, landslides, or faults relative to the subject site; existing and proposed topographic profiles; existing and proposed structures; and, required Code setbacks. (7006.3.2)
8. Provide geological cross sections illustrating existing and proposed grades and structures through the highest, steepest and geologically critical slopes.
9. Provide additional deep exploration with visual inspection by the geologist to verify the depth and extent of the landslide, confirm or rule-out the presence of any shears, slide planes, weak layers etc. and to perform sampling and laboratory testing of such features/earth materials.
10. Provide a table summarizing all available strength values for along bedding and cross bedding; landslide debris; and, any other earth materials from the researched reports. Also indicate the values selected by the consultant.



11. Revise static and seismic slope stability analyses to consider both planar and circular potential failure planes, the weakest material profile, and the critical geologic cross sections.
12. The pseudo-static load of 0.15 g does not appear to be in conformance with current code. Revise the pseudo-static slope stability analysis to be in conformance with the most recent version of CGS Special Publication 117 (i.e. SP 117A), Guidelines for Evaluating and Mitigating Seismic Hazards in California (1803.7.2), and with the Department guidelines presented in the Memorandum dated 07/16/2014 (in the event the consultant does not have the memorandum, the reviewers could be contacted to send it via email). Notes: (1) Ground motions used to evaluate liquefaction or slope stability shall be obtained based on methods prescribed in the 2017 LABC (refer to 1803.5.12). Ground shaking hazard maps found in previous Seismic Hazard Zone Reports shall no longer be used to estimate ground shaking. The predominant earthquake magnitude-distance pair may be obtained from the USGS Interactive Deaggregation web site: <https://earthquake.usgs.gov/hazards/interactive/>. (2) The seismic coefficient,  $k_{eq}$ , shall be derived based on a displacement of 5 cm where critical slip surfaces intersect stiff improvements, such as buildings or pools, otherwise a maximum displacement of 15 cm may be assumed. (3) A minimum safety factor of 1.0 is required.
13. Provide seismic design parameters in accordance with the current requirements in the 2017 Los Angeles Building Code.
14. Provide retaining wall/basement design calculations and recommendations for lateral earth pressure due to earthquake motions for walls higher than 6 feet, as required by section 1803.5.12 of the 2017 Los Angeles Building Code.

Note: The Department requires that the acceleration to be applied to the retained mass not be less than  $\frac{1}{2}$  of  $\frac{2}{3}$  the PGAM (Maximum Considered Earthquake-Geometric Mean, MCEG peak ground acceleration adjusted for Site Class effects, ASCE 7-10 Eq. 11.8-1).

The geologist and soils engineer shall prepare a report containing an itemized response to the review items indicated in this letter. If clarification concerning the review letter is necessary, the report review engineer and/or geologist may be contacted. Two copies of the response report, including one unbound wet-signed original for archiving purposes, a pdf-copy of the complete report in a CD or flash drive, and the appropriate fees will be required for submittal.



CASEY LEE JENSEN  
Engineering Geologist Associate III



ALAN DANG  
Structural Engineering Associate II

CLJ/AD:clj/ad  
Log No. 102389  
213-482-0480

cc: Thienes Engineering, Inc., Applicant  
LGC Geotechnical, Inc., Project Consultant  
SP District Office



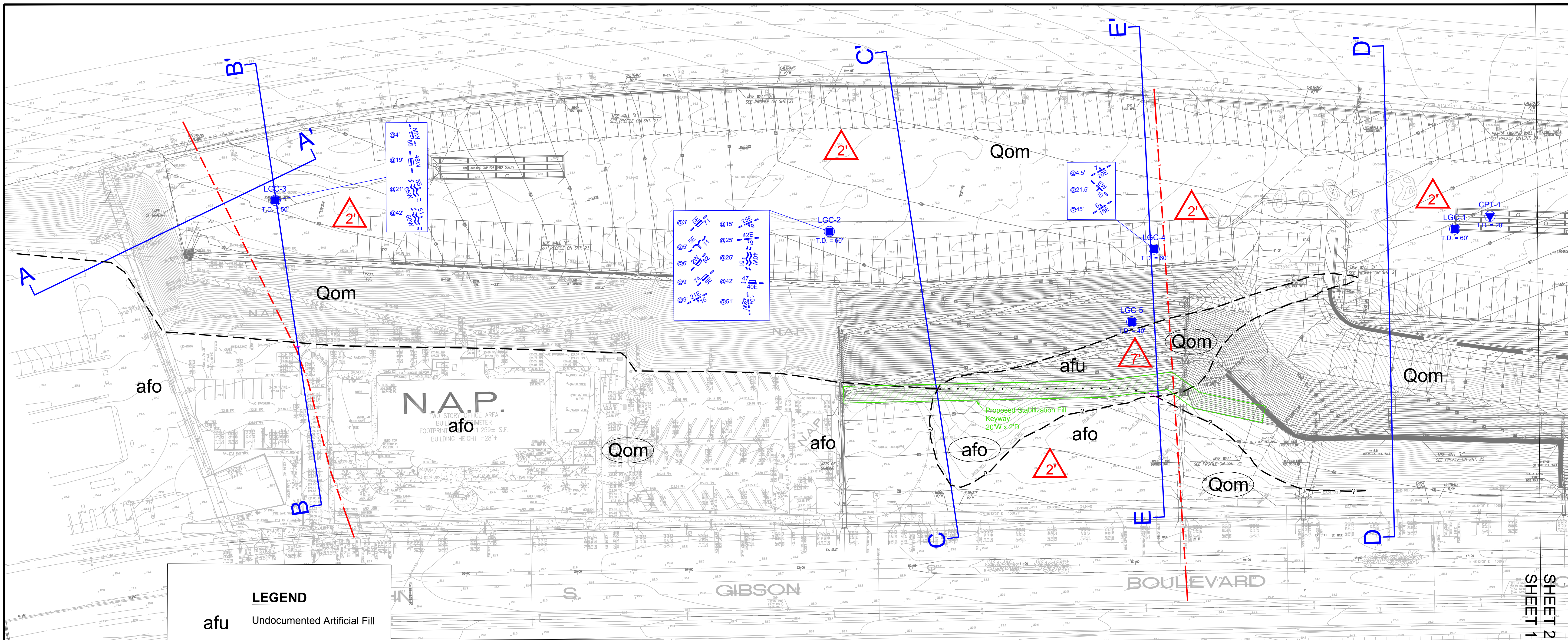

**LEGEND**

- afu Undocumented Artificial Fill
- afo Older Artificial Fill
- Qls Quaternary Landslide Deposit
- Qom Quaternary Old Marine Terrace Deposits
- LGC-BA-6
- ⊕ T.D. = 60' Approximate Location of Bucket Auger Boring (LGC Geotechnical)
- ⊕ T.D. = 40' Approximate Location of Bucket Auger Boring (Lawson, 2005)
- ⊕ T.D. = 20' Approximate Location of Cone Penetrometer Test (CPT) Sounding (Lawson, 2005)
- - - - - Approximate Location of Geologic Contact, Queried Where Uncertain
- - - - - Approximate Location of Fault, Queried Where Uncertain (CGS, 2016)
- · - · - · - Approximate Location of Recommended Subdrain
- └┬┘ Alignment of Geologic Cross Section
- ▨ Proposed Keyway
- △ 15' Approximate Anticipated Removal Depth Below Existing Grade
- Geologic Attitudes (Dashed Where Subsurface)**
- General Bedding
- Bedding
- Shear
- Joint
- Rupture Surface

SHEET 2  
SHEET 1

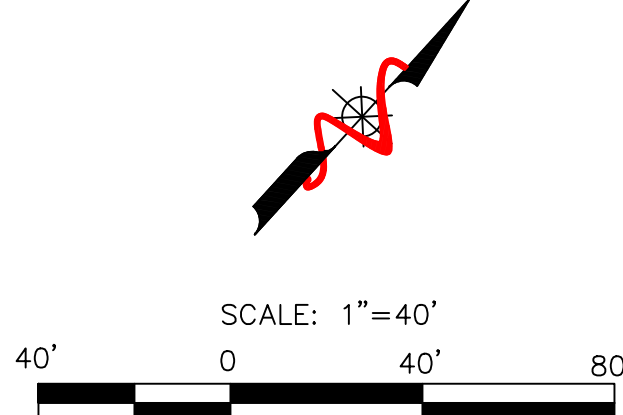

**LGC Geotechnical, Inc.**  
 131 Calle Iglesia, Ste. 200  
 San Clemente, CA 92672  
 TEL (949) 369-6141 FAX (949) 369-6142

**Geotechnical Map**

PROJECT NAME	San Pedro Distribution Center
PROJECT NO.	12091-01
ENG. / GEOL.	BTZ / KBC
SCALE	1" = 40'
DATE	March 2019

**SHEET**  
1 of 5



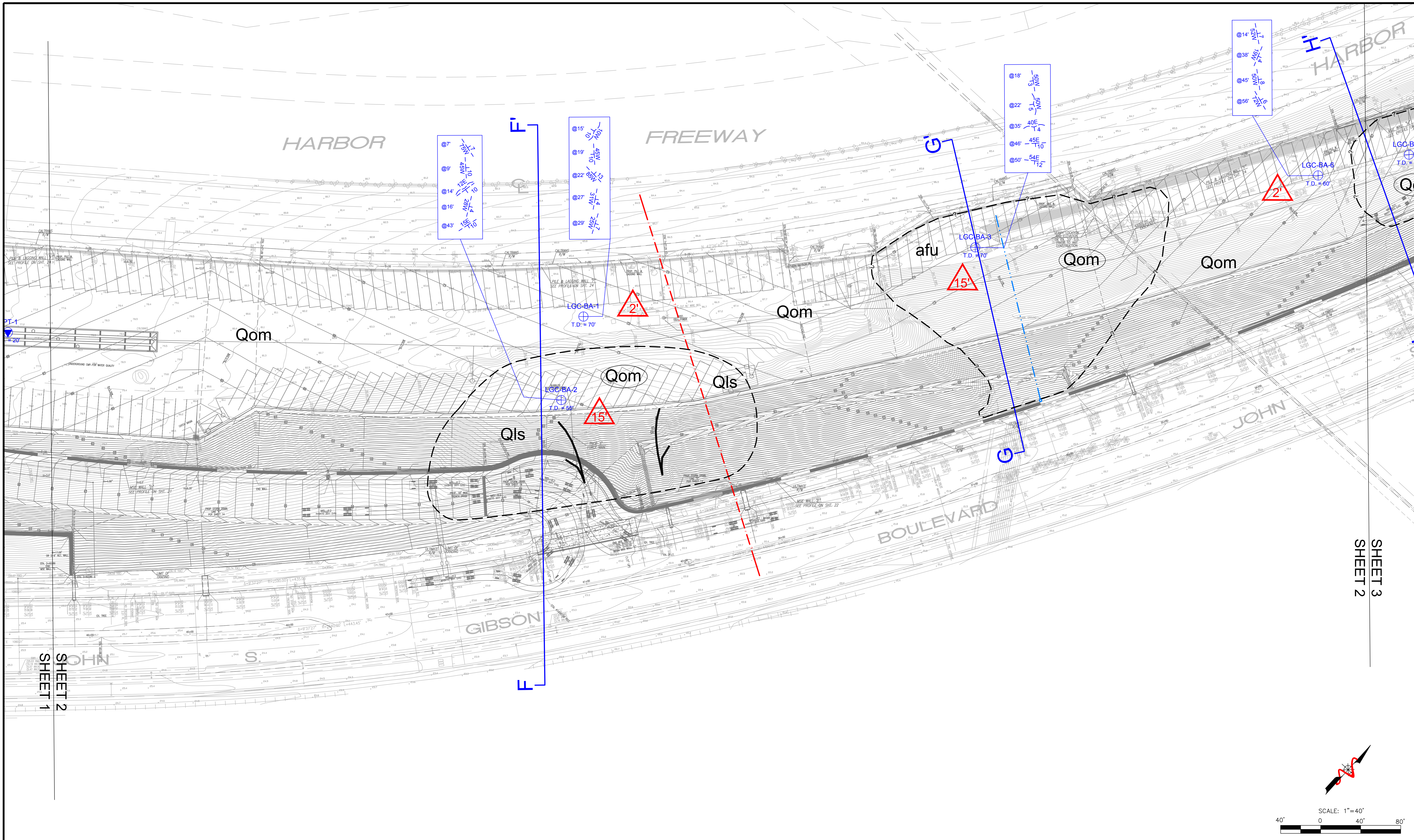

SHEET 1  
SHEET 2

SHEET 3  
SHEET 2



**LGC Geotechnical, Inc.**  
 131 Calle Iglesia, Ste. 200  
 San Clemente, CA 92672  
 TEL (949) 369-6141 FAX (949) 369-6142

**Geotechnical Map**

PROJECT NAME	San Pedro Distribution Center
PROJECT NO.	12091-01
ENG. / GEOL.	BTZ / KBC
SCALE	1" = 40'
DATE	March 2019

**SHEET  
2 of 5**



SHEET 3  
SHEET 2

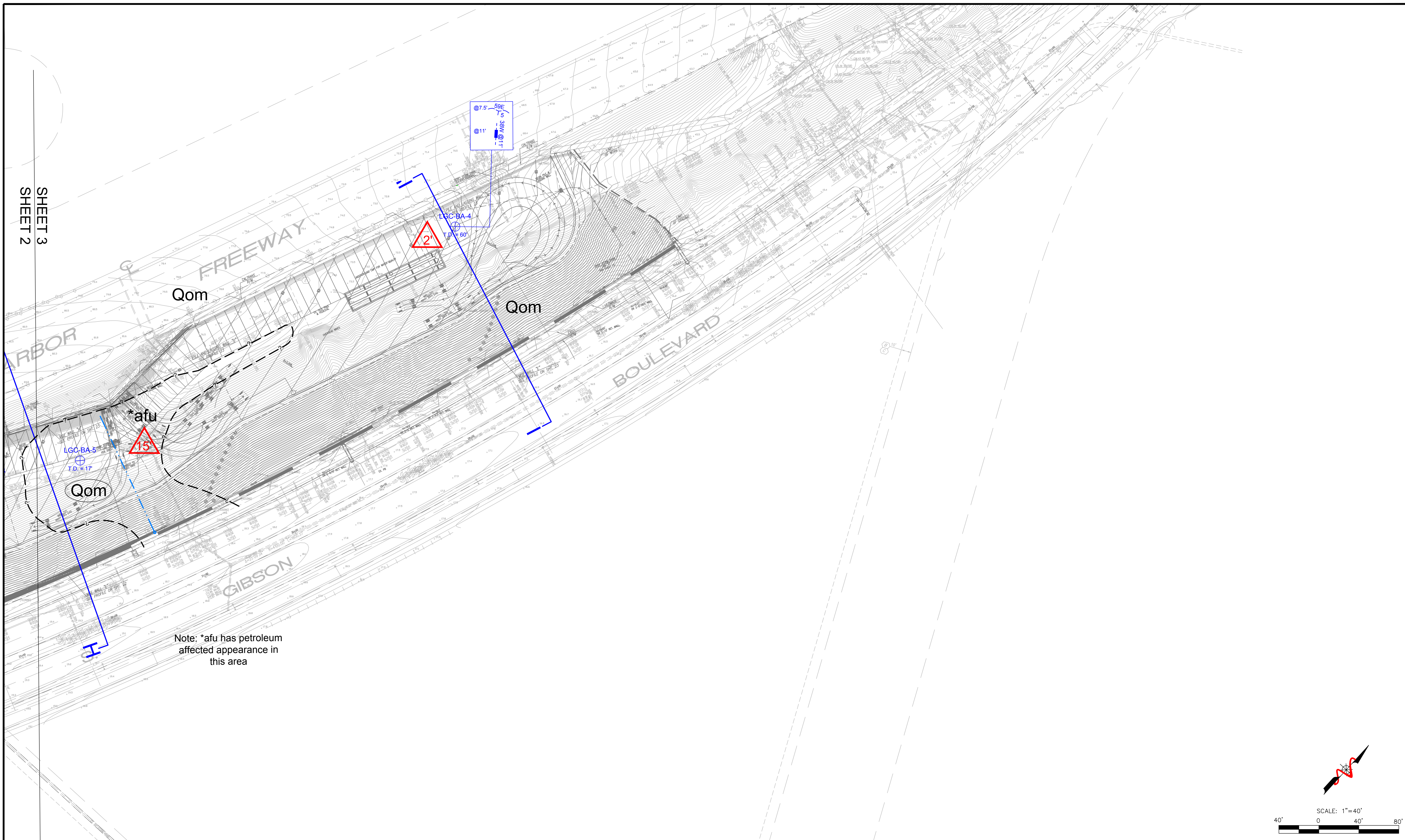

Note: \*afu has petroleum  
affected appearance in  
this area



LGC Geotechnical, Inc.  
131 Calle Iglesia, Ste. 200  
San Clemente, CA 92672  
TEL (949) 369-6141 FAX (949) 369-6142

### Geotechnical Map

PROJECT NAME	San Pedro Distribution Center
PROJECT NO.	12091-01
ENG. / GEOL.	BTZ / KBC
SCALE	1" = 40'
DATE	March 2019

**SHEET**  
**3 of 5**



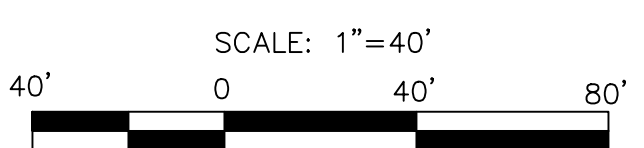
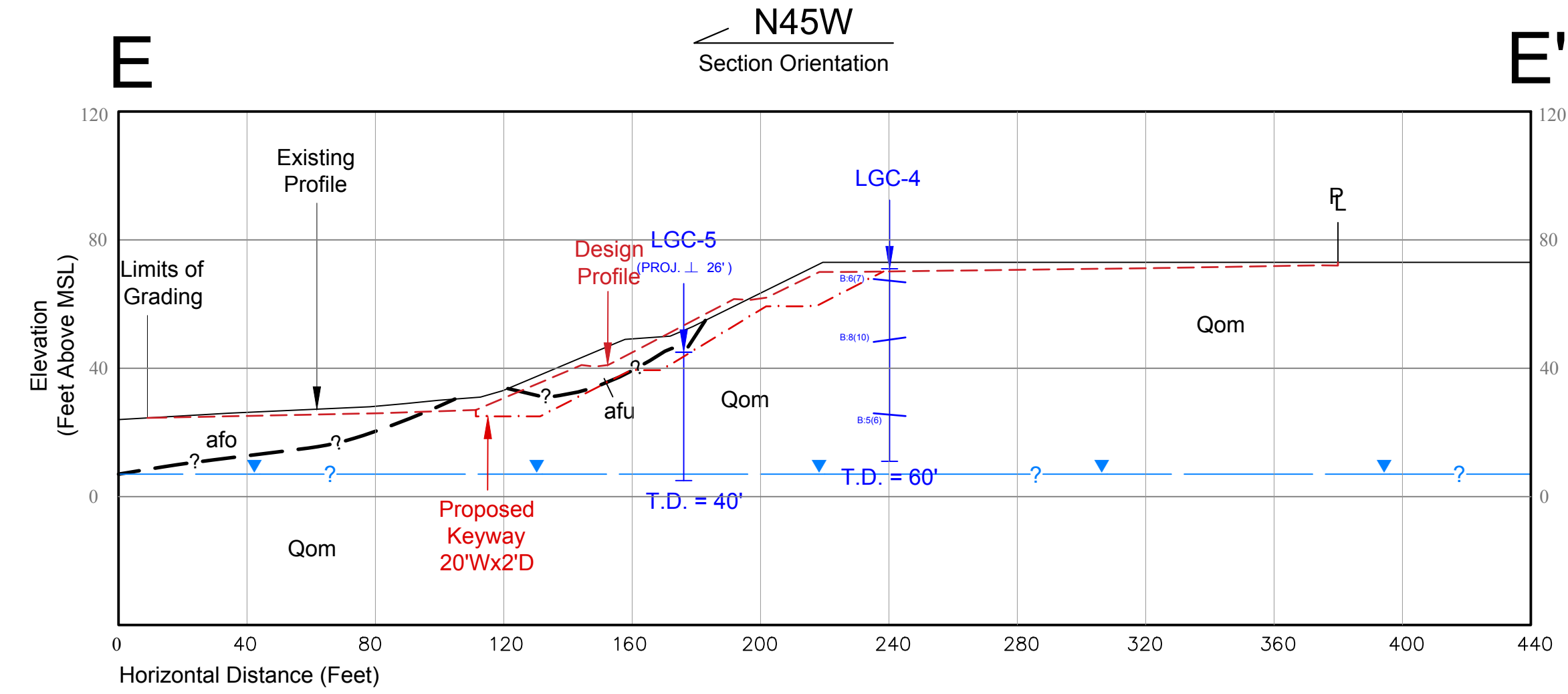
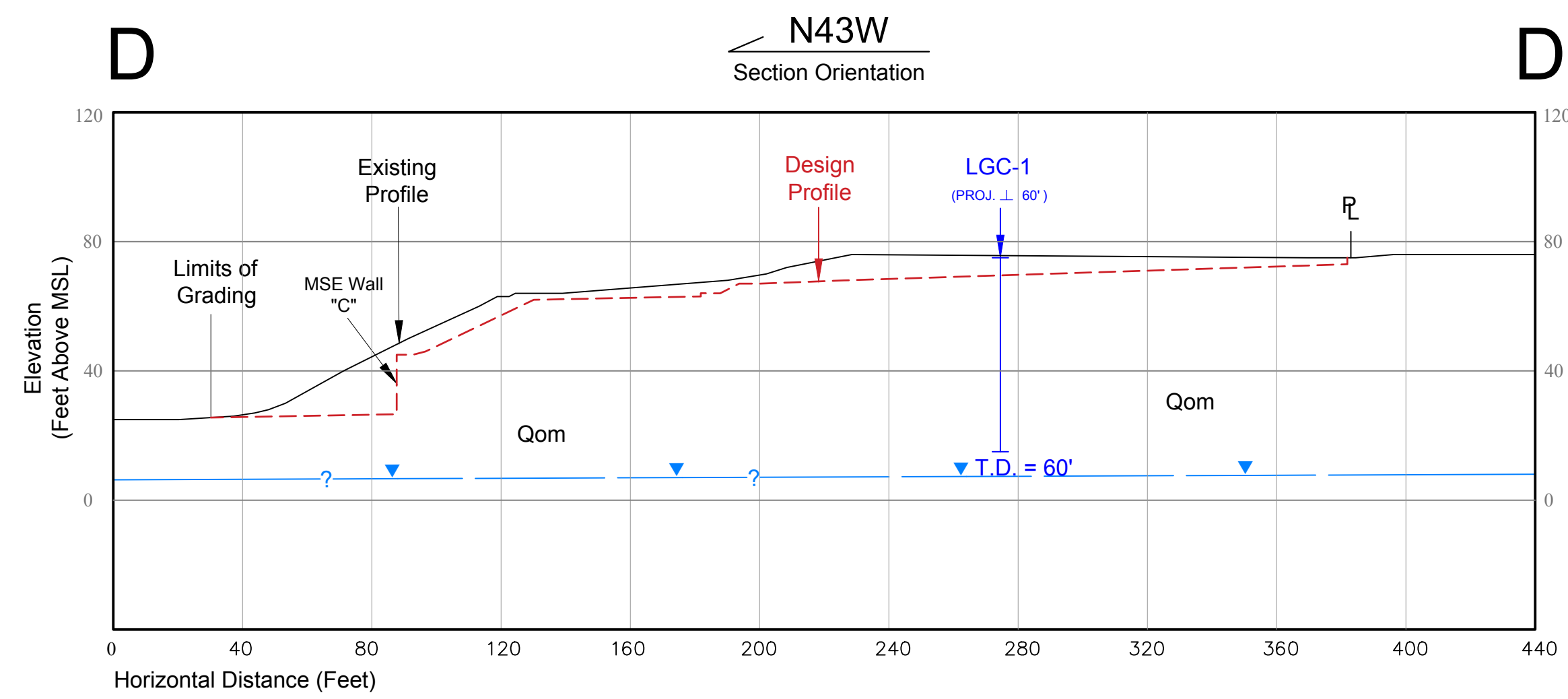
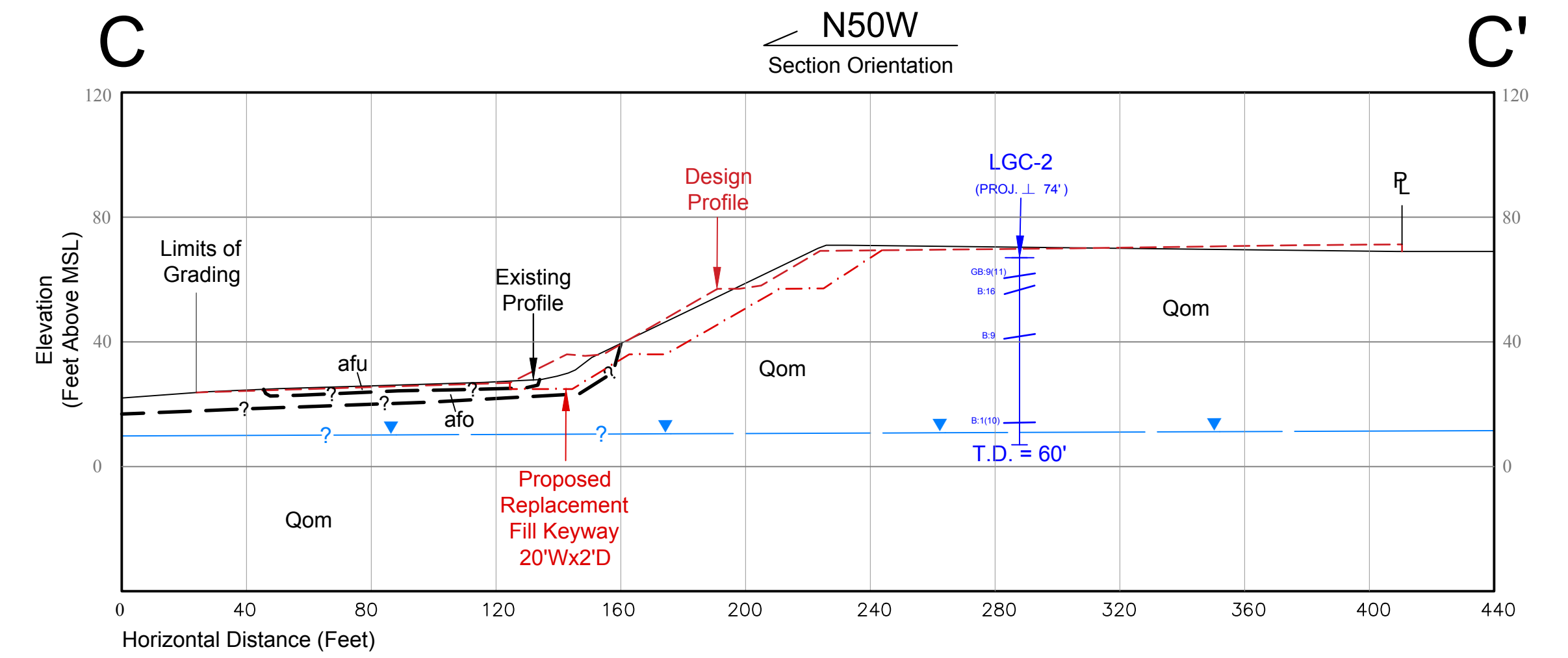
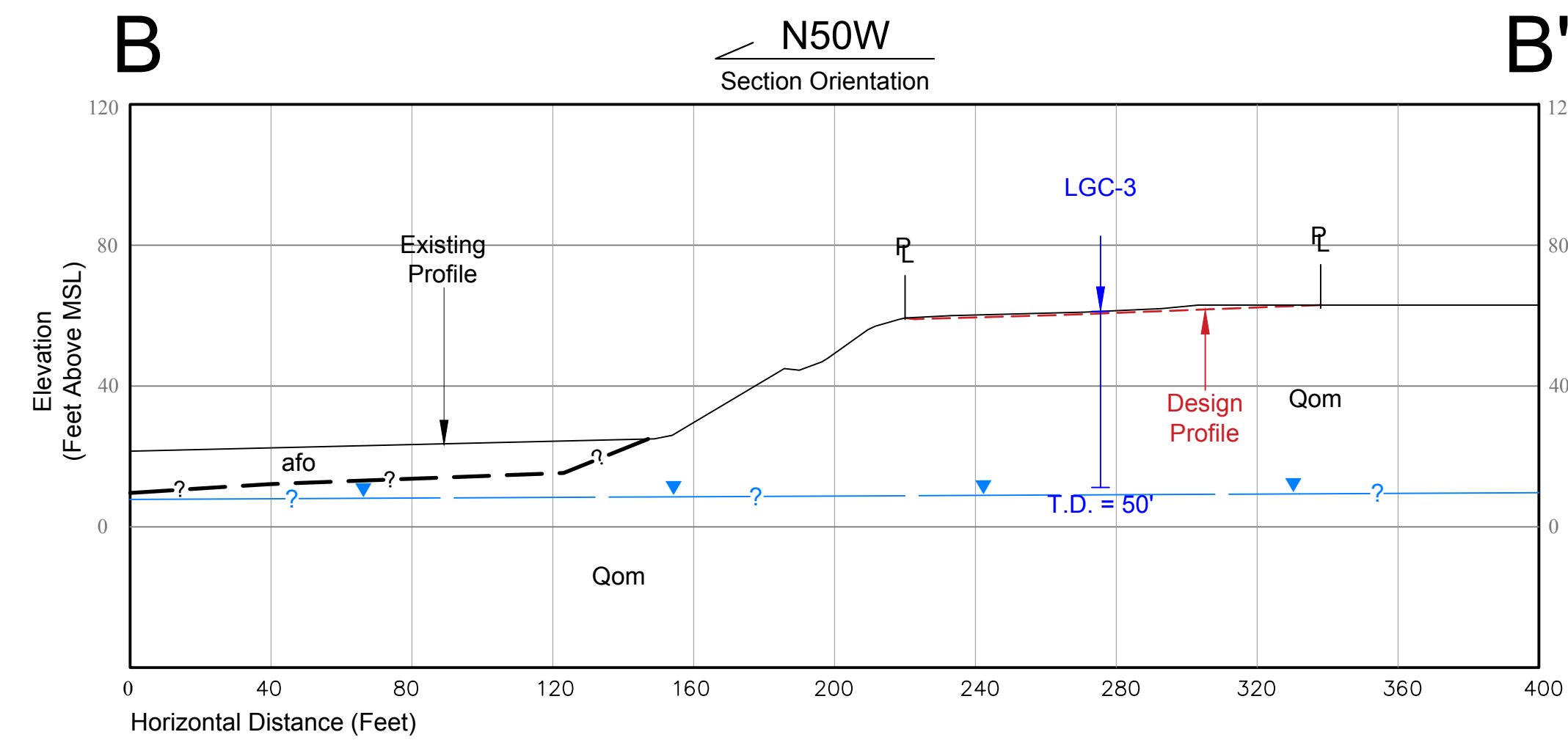
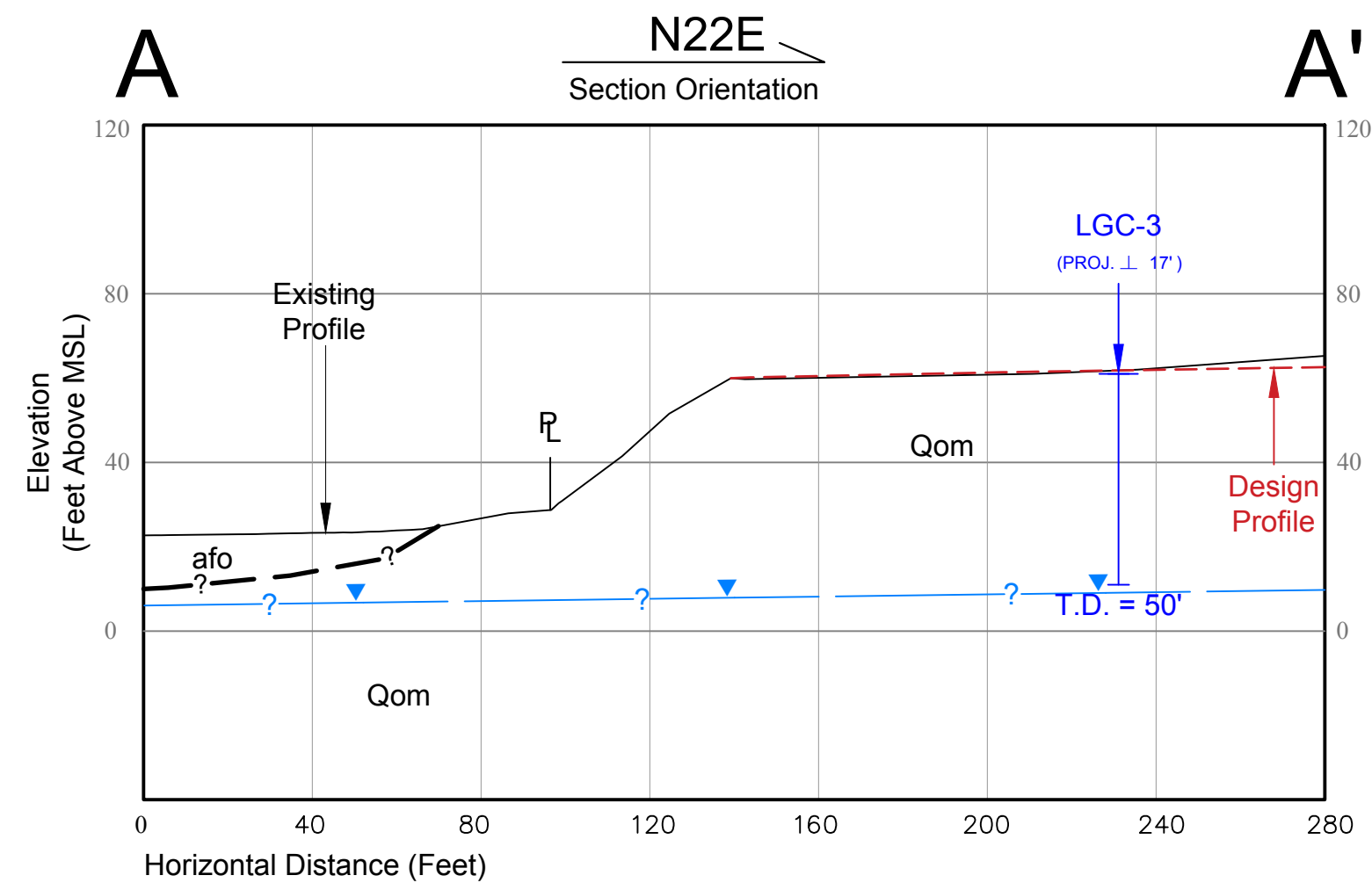

**LGC Geotechnical, Inc.**  
 131 Calle Iglesia, Ste. 200  
 San Clemente, CA 92672  
 TEL (949) 369-6141 FAX (949) 369-6142

**Geotechnical Cross Sections A-A' Through E-E'**

PROJECT NAME	San Pedro Distribution Center
PROJECT NO.	12091-01
ENG. / GEOL.	BTZ / KBC
SCALE	1" = 40'
DATE	March 2019

**SHEET**  
**4 of 5**

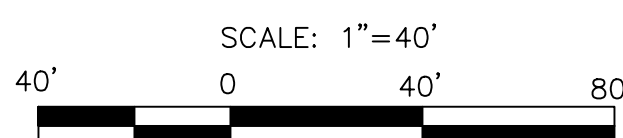
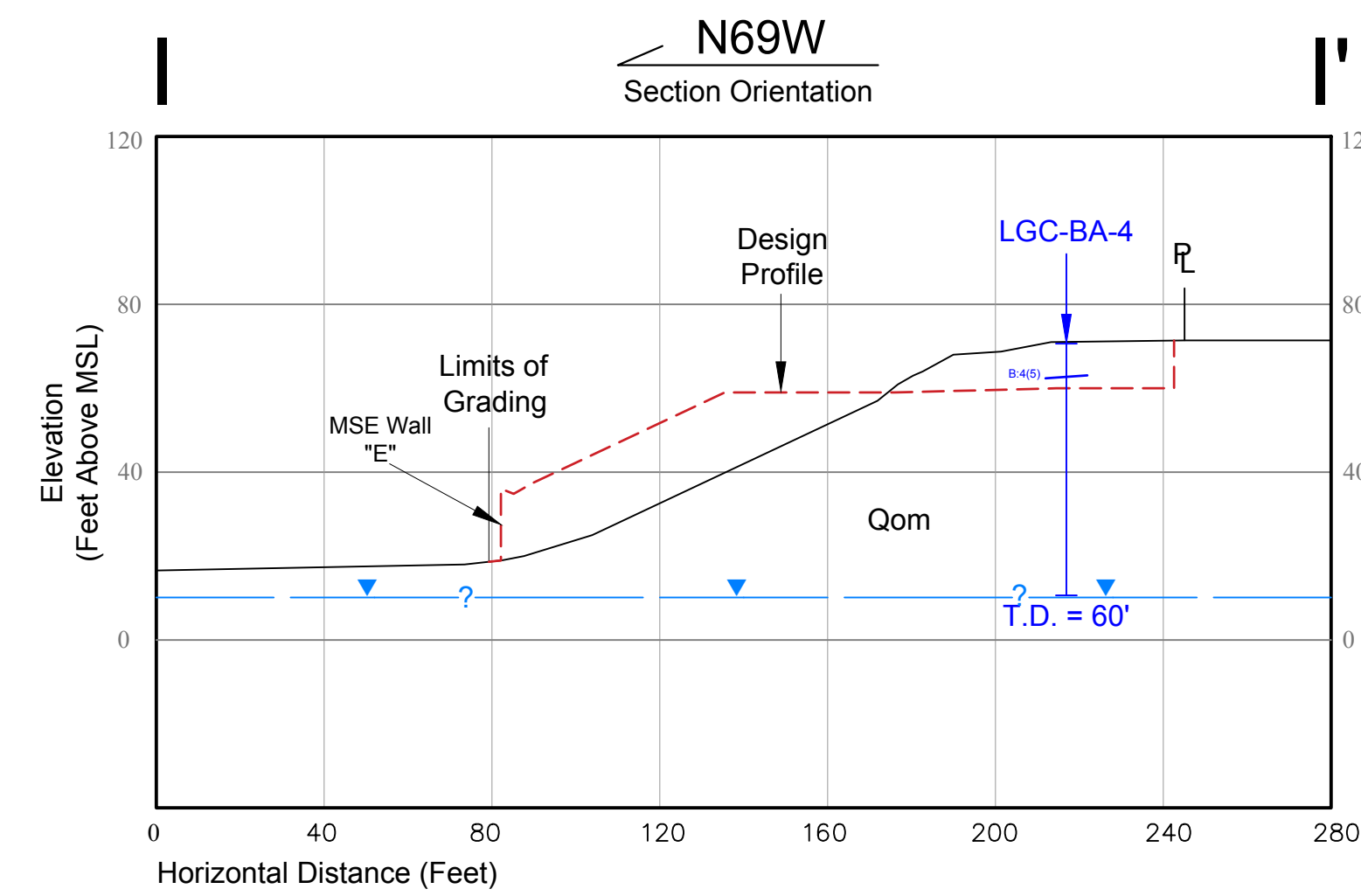
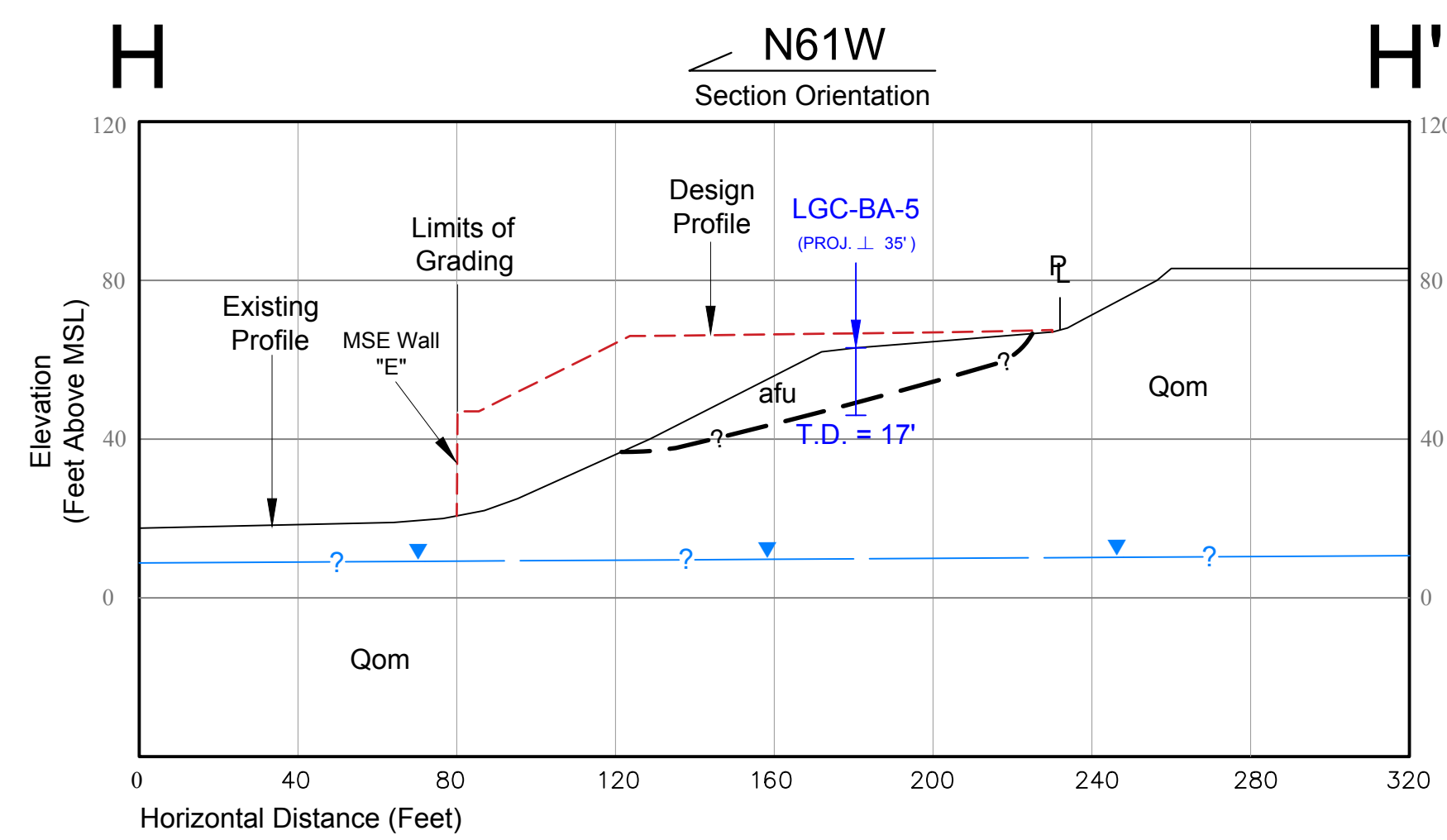
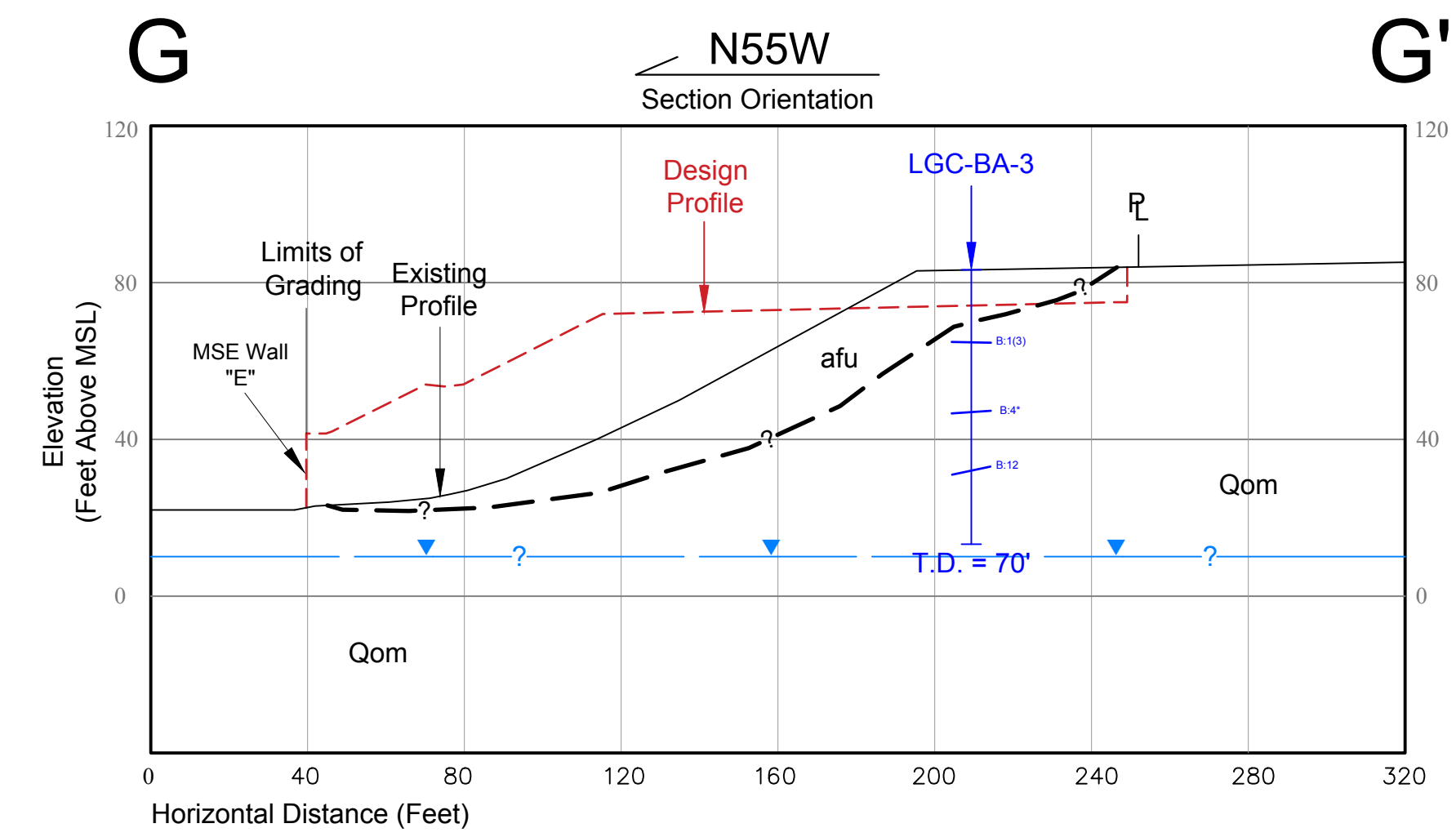
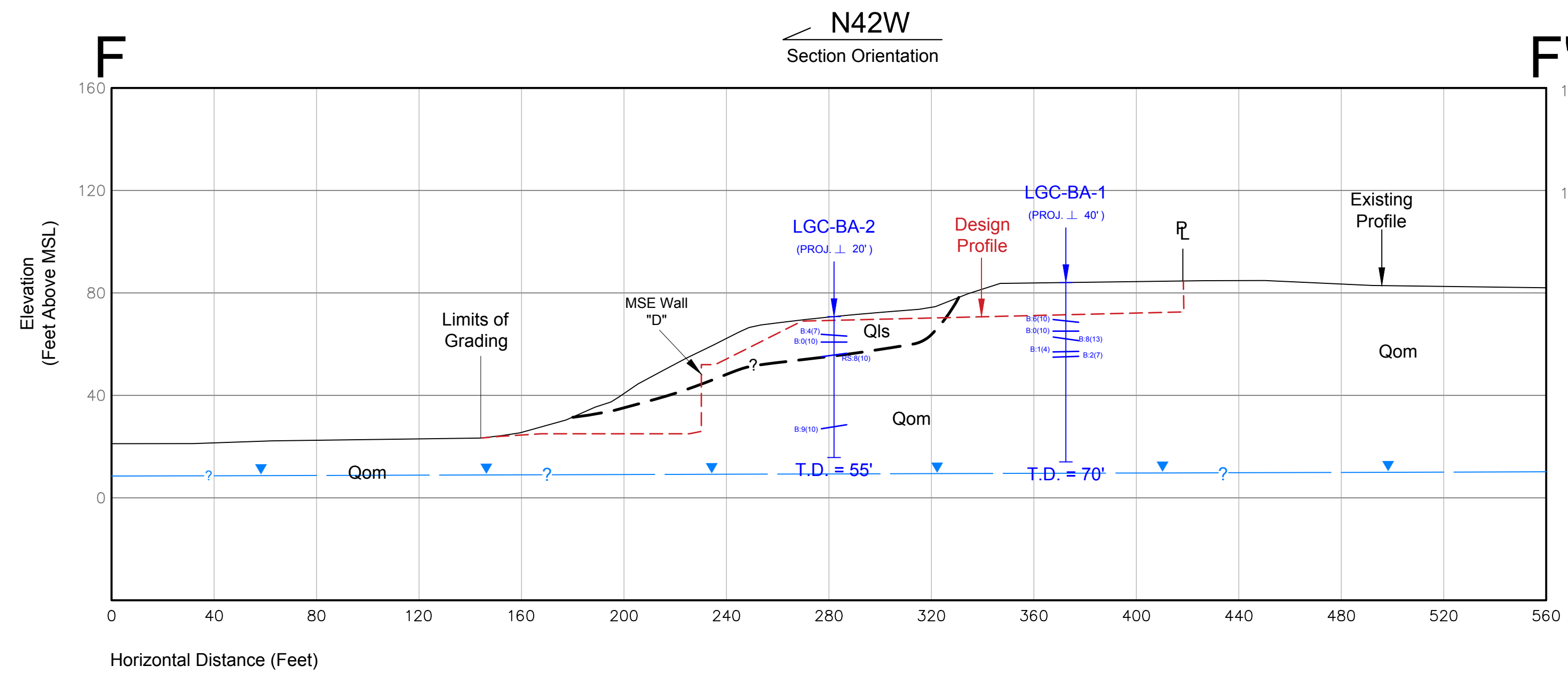

**LGC Geotechnical, Inc.**  
131 Calle Iglesia, Ste. 200  
San Clemente, CA 92672  
TEL (949) 369-6141 FAX (949) 369-6142

**Geotechnical Cross Sections F-F' Through I-I'**

PROJECT NAME	San Pedro Distribution Center
PROJECT NO.	12091-01
ENG. / GEOL.	BTZ / KBC
SCALE	1" = 40'
DATE	March 2019

**SHEET**  
**5 of 5**